

# 1990 Catalog

## Reference Guide to Digital Waveform Instruments

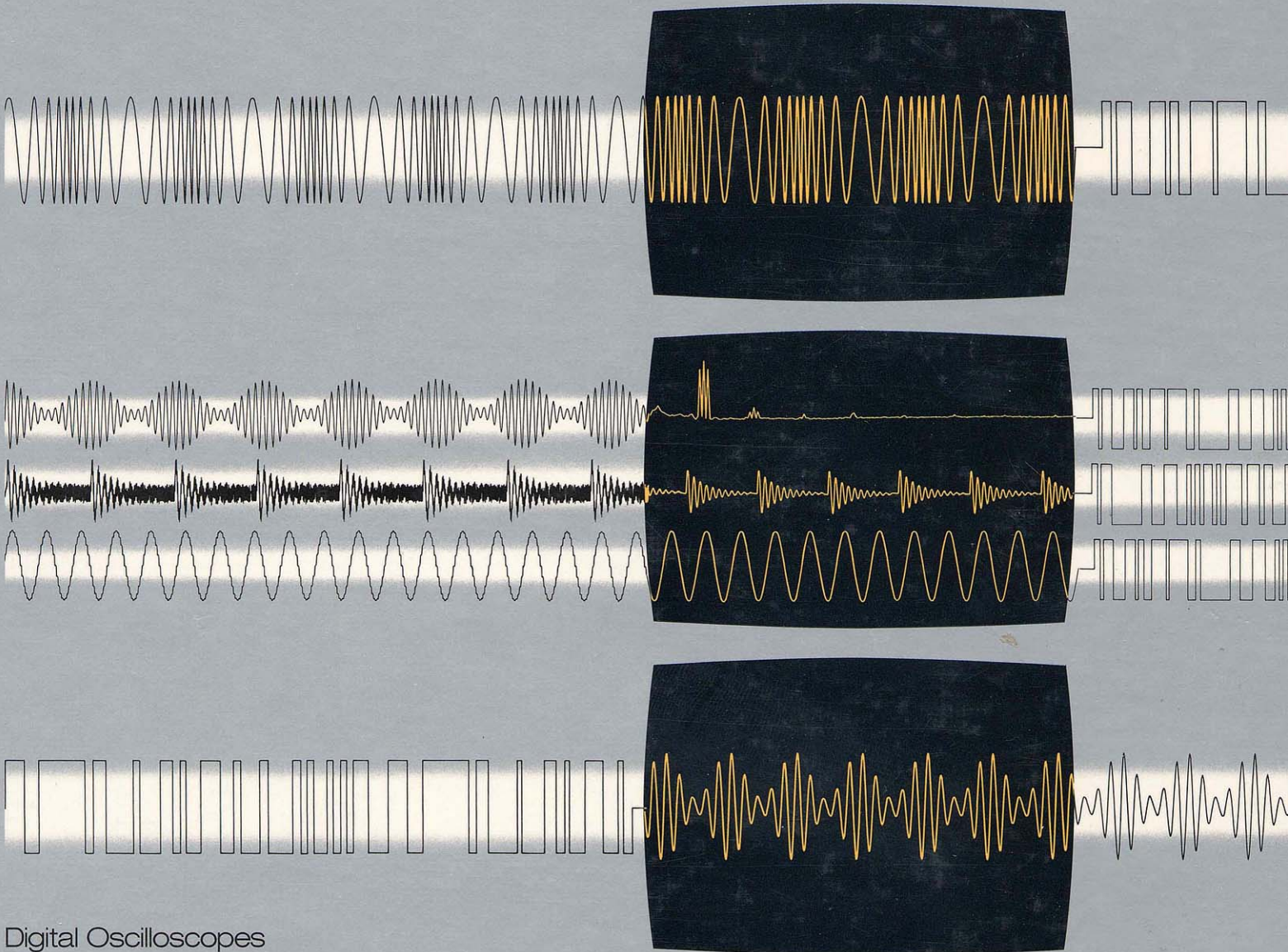

Digital Oscilloscopes  
Modular Waveform Digitizers  
Signal Sources

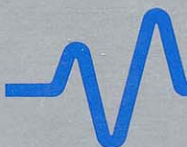

**LeCroy**

*Innovators in Instrumentation*



---

# JUST RELEASED!

---

*Believable Performance at an Unbelievably Low Price...*

## The New LeCroy 9410 Digital Oscilloscope

A powerful, versatile, dual channel instrument that gives premium performance at a surprisingly low price. Take a look at the outstanding features the 9410 brings to your bench.

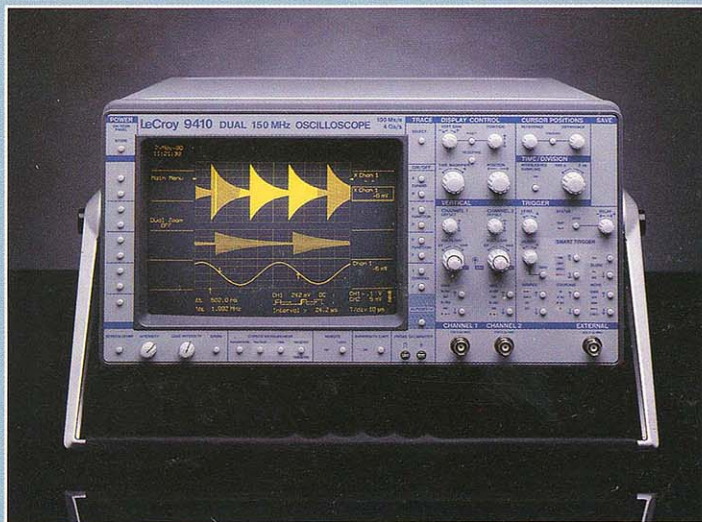

- 100 MS/s single shot sampling rate
- 4 GS/s for repetitive signals
- 150 MHz bandwidth
- 2 independent channels
- Automatic waveform parameter measurements
- Long record lengths
- Signal processing (math, XY display, and averaging standard, FFT and complex math optional)
- Advanced trigger modes, including TV trigger
- Fully programmable, GPIB and RS232-C
- Optional 512 K "credit card" mass storage

Due to the recent release of the 9410, details are not contained within this catalog. For more information, please either send in the return card, or call **1-800-5-LeCroy** in the USA or your local LeCroy office listed in Appendix G.

### About the Cover ...

**Cover:** The front cover represents a stylized variety of waveform capture, display, processing and generation functions characteristic of LeCroy digital waveform instruments.

**Top:** Analog signal is captured and displayed. Digital representation is stored and available for processing or other purposes.

**Second:** Modulated sine wave is captured and Fourier transformed.

**Third:** Noisy damped sine wave is captured and signal averaged, eliminating random noise.

**Fourth:** Ragged high frequency sine wave generated from a DAC is captured and "smoothed" in a digital scope.

**Bottom:** Digital data is converted to an analog waveform within an arbitrary function generator, and is available for signal generation.

---



# NEW PRODUCTS



## Model 9424 Quad-Channel 350 MHz Digital Oscilloscope

- 350 MHz bandwidth, 8-bit digitizing
- 100 MS/sec single shot; 10 GS/sec random interleaved sampling
- Wide 50 K memory per channel
- Large, bright display shows 4 traces simultaneously
- 2% DC accuracy and 0.001% horizontal resolution
- Built-in arithmetic, XY mode, and pulse parameters
- Simultaneous summation averaging on all channels
- SMART triggers: FASTGLITCH, pattern, interval, TV, ...

## Model 7200 Modular Digital Oscilloscope

- Anti-obsolescence — A plug-in based instrument that can grow as needs and technology change
- 2-Channels, 4-channels, and more
- 1 GS/sec single shot; 20 GS/sec random interleaved sampling
- 400 MHz bandwidth, 875 psec risetime
- 8 bits with enhancement to 11 bits
- 50 K memory per channel, with mass storage built in
- SMART triggering — more than 25 options
- FFT, waveform math, averaging, statistics, trending
- Control, decision making



## Model 9112 High Resolution, High Accuracy Arbitrary Function Generator

- Two independent channels
- Amplitude resolution, 12 bits
- Flatness: <math><0.1\text{ dB}</math>
- DC accuracy of 0.3% into any load from 49 Ohms to 1 M $\Omega$
- Both analog signal and digital pattern outputs
- Supported by EASYWAVE<sup>®</sup> waveform creation software

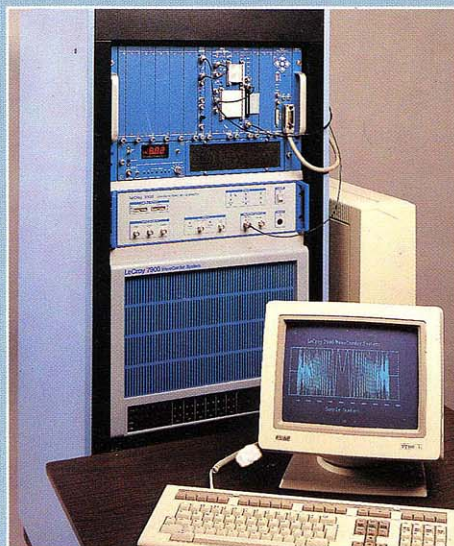

## Model 7900 Series Wavewriter Mass Memory Digitizing System

- Captures waveform data from 0-200 Mbytes/sec for each of 2 channels
- 10-640 Mbytes of *seamless* storage
- Supports 8 or 12-bit sample sizes
- Real time analog playback available
- Supports VAX<sup>®</sup>, MicroVAX<sup>®</sup>, VME-based systems, and IBM-PC/AT<sup>®</sup> hosts



# The LeCroy Organization



Corporate  
Headquarters  
Chestnut Ridge,  
New York USA



European  
Headquarters  
Geneva,  
Switzerland

LeCroy Corporation is a 26 year old, service-oriented U.S. owned company with extensive R&D and manufacturing both in the USA and in Europe. It has wholly-owned sales and service organizations in six European countries and regional sales/service-centers and field sales engineers throughout the USA. Representatives are used in other locations. LeCroy's dedication to local product support and service is manifest in its responsive service facilities and its selection of consultative sales engineers and service-qualified distributors.

Structurally, LeCroy is comprised of dynamic business units, each responsible for defining, developing, marketing, and producing its own products.

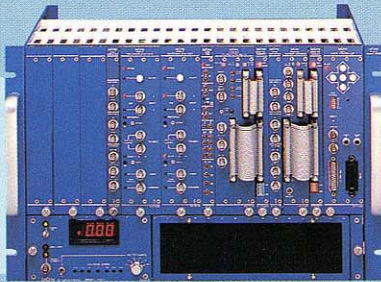

## Automated Test Systems Division (ATS):

Responsible for Modular Digitizer Systems in the IEEE-583 (CAMAC) standard, and LeCroy's latest high performance benchtop digital oscilloscopes, Series 7200.



## Research Systems Division (RSD):

Responsible for ultra-wide-memory modular digitizer systems (7900 Series Wavecorder), and all high energy physics research products.



## Interactive Test Instruments Division (ITI):

Responsible for high performance portable digital oscilloscopes.

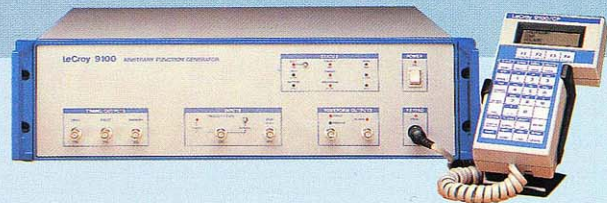

## Signal Sources Division (SSD):

Responsible for Arbitrary Function Generators and an expanding line of other signal sources.

## Sales and Service Division (CSD):

Responsible for field sales, service and customer support, the LeCroy sales organization represents all LeCroy divisions and markets, worldwide.





---

---

# LeCroy 1990 Catalog and Reference Guide to Digital Waveform Instruments

---

## LeCroy Corporation

700 Chestnut Ridge Road, Chestnut Ridge, NY 10977-6499

Tel: (914) 425-2000 • FAX: (914) 425-8967 • TELEX: 710-577-2832

## Twenty-six Years of Service and Growth

1990 marks LeCroy Corporation's twenty-sixth year of service to engineers and scientists in the field of high-speed electronic measurement instrumentation, and our twenty-sixth year of steady growth.

We are grateful for the acceptance shown our products over the years. To find our instruments serving working engineers and scientists in so many diverse areas of research, development and manufacturing is a great source of pride and satisfaction.

Our consistent aim has been to provide imaginative, reliable instruments...instruments that meet real needs, and that represent the best solutions that current technology can offer to the problems they address.

Our strategy for our own success is straight-forward: we try to do whatever is necessary to make our customers successful. This is reflected, we think both in the features of our products and in the level of service and support we provide to our users.

Wherever it makes sense, we welcome the opportunity to become partners with our users, bringing joint resources to bear on problems in a more effective way than the usual buyer-seller relationship permits. This helps our users, and it helps us. We learn about the strengths and weaknesses of our products and the real needs of our users, making sensible product improvement possible. We encourage similar relationships with our own vendors. Teamwork pays, for everyone.

If you are presently among our customers, we'd like to express our gratitude and the hope that we can continue to be of service to you. And if you are not, please give us an especially careful look. Perhaps some of our products can help make your next project a little surer, more straight-forward, more rewarding.

Walter O. LeCroy  
Chairman of the Board



---

---

# Welcome to LeCroy's 1990 Catalog and Reference Guide to Digital Waveform Instruments

---

This publication is the first complete compendium of LeCroy waveform generation and measurement products oriented to the research, test and measurement fields. It provides selection guides, descriptions and specifications in enough detail to enable you to select items for demonstration or further consideration that are most appropriate for your application. However, this edition of the catalog does not document the entire LeCroy product line. A separate volume contains our instruments for High Energy Physics research.

As the attributes of digital waveform instruments involve concepts foreign to their analog counterparts, a selection of tutorial material is included in this book for ready reference. A convenient glossary in the Appendix defines terms used herein, and a tutorial section describes concepts from the fundamentals of waveform digitizing and digital oscilloscopes to the hows and

whys of arbitrary function generators. Other convenient references, like cable attenuation charts, conversion factors, and resistor codes are also provided.

In addition, realizing that digital instruments generally cost more than their analog counterparts, attention is given to explaining how conversion to digital waveform instruments pays in the long run. Hopefully, the concepts presented therein will be of interest to you.

LeCroy instruments strive to give you the high performance and convenience of operation that you should expect from your equipment. Similarly, this catalog and reference guide is intended to help make the decision process more efficient.

Please feel free to call if we can be of further service.

---

## CREDITS

ASYST is a registered trademark of Asyst Software Technologies Inc.

Centronics is a registered trademark of Data Computer Corporation.

Compaq, Compaq III and Compaq 386 are trademarks of Compaq Computer Corporation.

EASYWAVE is a registered trademark of LeCroy Corporation.

Epson is a registered trademark of Epson America, Inc.

FASTGLITCH and WAVEFORM CATALYST and SMART are Trademarks of LeCroy Corporation.

Graphtec is a registered trademark of Graphtec Corporation.

HP, Thinkjet, Quietjet, and Laserjet are registered trademarks of Hewlett Packard Corporation.

IBM, IBM PC, IBM PC/XT, IBM PC/AT, and IBM Personal System 2 are registered trademarks of International Business Machines Corporation.

MS-DOS is a registered trademark of Microsoft Corporation.

PC-2 and PC-2A are trademarks of National Instruments Inc.

Philips is a registered trademark of Philips Test & Measurement Inc.

VAX, MicroVAX, VMS, QBUS, and UNIBUS are registered trademarks of Digital Equipment Corporation.

© 1990, LeCroy Corporation. LeCroy is a registered trademark of LeCroy Corporation. All right reserved. Information in this publication supercedes all earlier versions. All specifications within are subject to change without notice.  
20M-CMA-10

UNIX is a registered trademark of AT&T

---



---

---

# Table of Contents

---

	<b>Page No.</b>
<b>INTRODUCTION</b>	
New Products	Intro
The LeCroy Organization	Intro
The LeCroy Tradition	v
Justifying Digital Instruments	ix
Customer Service and Service Products	xv
<b>PORTABLE and BENCHTOP DIGITAL OSCILLOSCOPES</b>	
Overview of Products	
Digital Oscilloscope Selection Guide	I-1
About Digital Oscilloscopes	I-2
Product Technical Data	
Models 9450, 9420, 9424 and Options	I-4
Model 9400A and Options	I-23
Model CS01 Calibration Software	I-37
Model 7200 Series	I-40
Pictorial Scope Feature Highlights	I-48
Digital Oscilloscope Accessories	I-51
<b>SIGNAL SOURCES</b>	
Overview of Products	
Arbitrary Function Generator Selection Guide	II-1
About Arbitrary Function Generators	II-2
Product Technical Data	
Models 9100, 9101, 9109, 9112	II-4
Model 9100/SW EASYWAVE Software	II-16
<b>MODULAR DIGITIZER SYSTEMS</b>	
Overview of Products	
Section Contents Location Guide	III-1
About Modular Digitizer Systems	III-2
Digitizer and Memories Selection Guide	III-4
Product Technical Data:	
Digitizers and Memories	III-6
Cables, Accessories, 7900 Series Components	III-35
Amplifiers, Attenuators, Transmitters/Receivers	III-36
Pulse, Gate, Clock Generators, Fan Outs	III-42
Controllers, Interfaces, Averagers	III-48
System Control & Processing Software	III-56
Powered Mainframes	III-71



---

---

### **MODULAR DIGITIZER SYSTEMS (Cont.)**

More Products from LeCroy Time Interval Meters, High Voltage Systems, Components	III-78
Introduction to CAMAC	III-80

### **TECHNICAL TUTORIALS**

Fundamentals of Digital Oscilloscopes and Waveform Digitizers	IV-1
Benefits of Long Memories in Digital Oscilloscopes	IV-14
High Resolution Modes in Digital Oscilloscopes	IV-19
How to Trigger on the Most Elusive Events	IV-24
Fundamentals of Analog to Digital Conversion	IV-32
Fundamentals of Aliasing	IV-36
Principles of Digital Signal Processing	IV-40
The Hows and Whys of Arbitrary Function Generators	IV-48
How to Measure Effective Bits	IV-59

### **APPENDICES**

Appendix A - Glossary of Terms	V-1
Appendix B - Applications Literature & Publications	V-9
Appendix C - Attenuation of Cables	V-10
Appendix D - Conversions, Resistor Codes	V-12
Appendix E - Ordering Information	V-13
Appendix F - GSA Contract Products	V-14
Appendix G - Sales & Service Offices	V-15
Appendix H - Sample Purchase Justification Form	V-17
Appendix J - Product Index	V-20
Appendix K - Subject Index	V-21



## The LeCroy Tradition

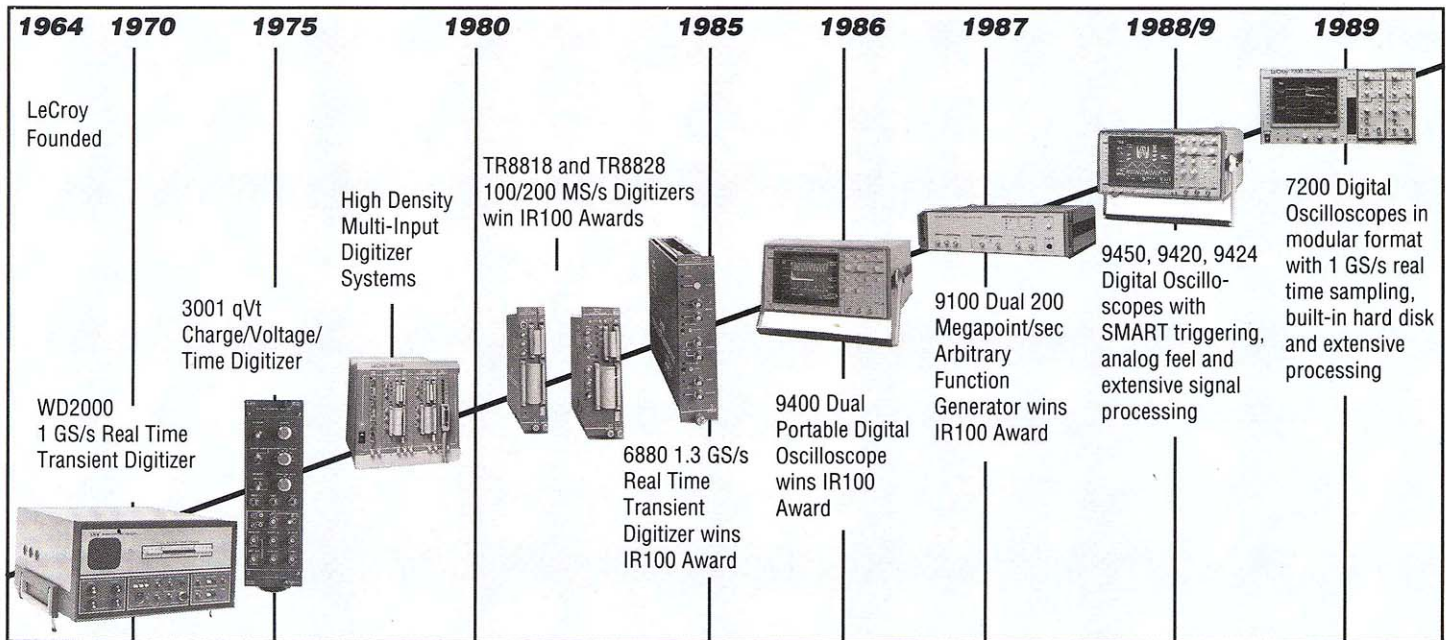

LeCroy Corporation was established in 1964, designing and producing equipment for High Energy Physics research. It has since risen to become the major supplier of modular, high-speed, high precision analog and digital measuring instruments for a wide range of basic research disciplines. These products include instruments for small pulse measurement, high-rate pulse counting, precise time interval measurement, precise coincidence measurements, multichannel analysis, high speed waveform digitizing, analog and digital fiber optic signal transmission, and programmable high voltage distribution systems. Full details on those research instruments geared to the Physics Research field may be found in the LeCroy Nuclear Products Catalog, available upon request.

**SINCE LeCROY'S EARLY YEARS IN PHYSICS RESEARCH INSTRUMENTATION, "INNOVATION" HAS BEEN ITS GUIDING PRINCIPLE**

The principle characteristic of LeCroy's research-oriented instruments has always been "innovation", a tradition so strong that it has been the company's slogan, "Innovators in Instrumentation". Starting in the 1960's, LeCroy pioneered the development of precise, high density instruments, first packaging one channel, and then 2,4,8,12,24,48, and then 96 channels of complete, independent charge and time measurement into individual modular plug-ins. Today there are systems with up to 30,000 individual time or analog signal measurement channels of LeCroy instruments in operation in physics research environments.

LeCroy was the first to pioneer the use of custom hybrid circuits and monolithics in such measuring instruments, the first to create a multichannel analyzer for the spectroscopy market that measured charge and time as well as voltage, the first to provide large scale computer-controllable high voltage distribution systems. Even as early as 1969, LeCroy was



---

# Introduction

---

marketing a 1 nsec per sample real time waveform digitizer, truly a revolution from then-current travelling wave and storage oscilloscope fast signal measurement techniques. LeCroy's tradition of innovating has earned multiple recognitions in the form of IR-100 Awards, sponsored by the "Research & Development" journal. Six such awards for new products recognized in the "100 most significant new technical products of the year" were awarded to LeCroy since 1983.

## **LeCROY PRODUCTS GO BEYOND THE EXPECTED, OFFERING CAPABILITIES THAT FACILITATE AUTOMATION AND REPLACE OTHER INSTRUMENTS**

The products covered by this catalog have been developed by applying research measurement techniques to the problems in Test & Measurement. Because of the company's different background, the instruments that have resulted are different from those generally offered by traditional suppliers. For instance, since the physics research products were digital and computer-based from inception, LeCroy instrument development more fully exploited and made greater use of digital rather than analog-only technology. LeCroy products don't just use digital measurement and storage techniques to make the common functions easier to use, but to extend the instrument's capability. One good example of this is the extensive signal processing that is connected with each instrument. This capability facilitates automation, getting answers (not just data), and permits emulating and thus replacing other instruments.

Other differences are speed, accuracy and reliability. LeCroy products grew up in an environment where 100 MHz was deemed slow. A lot of proprietary technology had to be developed to support wide bandwidth, low noise instruments. Extensive custom IC's offered greater performance than would be available if the company were solely dependent upon commercial suppliers. LeCroy products typically excel at higher frequencies. For example, while the cost of a DSO is a strong function of its bandwidth, this is very often where its performance becomes marginal. The area for which you pay a premium is where it misbehaves! Not so with LeCroy. Our instruments are designed to operate "at speed," providing assured fidelity of the measurements without introducing aberrations or distortions.



*The uniqueness and appropriateness of high performance features in new LeCroy instruments has led to continual recognition in the form of IR-100 awards for the most significant new products of the year.*

## **LeCROY ADVERTISES SPECIFICATIONS THAT APPLY AS THE GENERAL RULE, NOT AS THE EXCEPTION**

Accuracy in measurement is part of the tradition required by the heritage of serving research disciplines. These areas, habitually subjecting data to computer calibration and analysis, have demanded unquestioned accuracy. LeCroy instruments that have grown out of this environment typically offer more resolution (indicated by memory length, bits, or signal-to-noise resolution) than comparable equipment.

In the field of particle physics, experiments run 24 hours a day for months or even years in remote operating areas subject to harsh electrical and other operating conditions. LeCroy instruments have had to be very reliable...another tradition which increases the value of the T&M products. You can see this tradition in the long warranty periods and guaranteed 3-day service turnaround offered, and in products that self calibrate so that preventive maintenance is virtually non-existent.



The tradition of innovation has even carried through to aesthetic aspects of LeCroy T&M equipment. Digital scopes are designed with a very easy-to-use "analog feel," intended to make the transition from the analog scope world to the digital scope world as transparent as possible in complexity to the new user. The displays on LeCroy scopes are large and bright, quite a contrast from that classically expected of oscilloscopes. In the latest LeCroy oscilloscope product, the instruction manual is even built in and readily accessible.

**LeCROY TRADITION DOESN'T STOP WITH INNOVATIVE TECHNICAL ACCOMPLISHMENTS. IT CARRIES THROUGH TO THE TO WAY THE COMPANY SERVICES ITS CUSTOMERS AND CARRIES ON ITS BUSINESS.**

"Service" is a key philosophy throughout LeCroy's facilities. Innovative service products that insure rapid solutions to user problems are available. LeCroy endeavors to provide field engineers who are capable of understanding your needs and adapting solutions to meet them. It provides competent and helpful field engineering assistants who delight in handling all the administrative details associated with quotations, completion of forms and certifications, order negotiations and acceptance, delivery expedites, and post-sale follow-up functions. LeCroy service managers and customer service representatives take pride in finding solutions to application or usage questions.

Implementing this service philosophy has recently resulted in LeCroy receiving the prestigious honor of the National Small



*LeCroy Corporate Headquarters, located near metropolitan New York in Chestnut Ridge.*

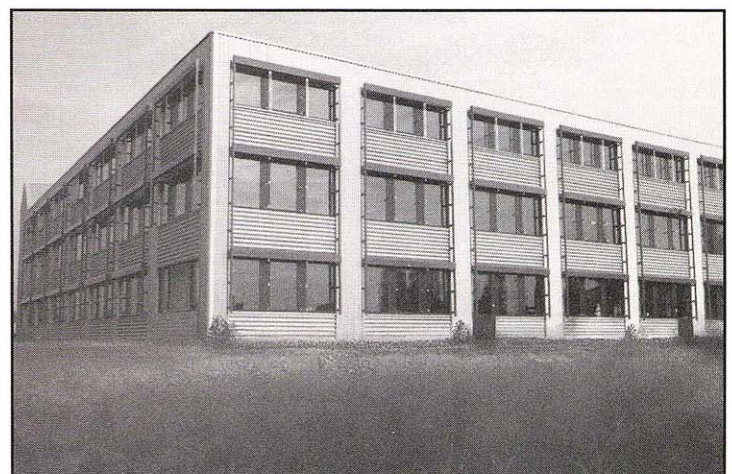

*LeCroy European Headquarters in Geneva, Switzerland.*



# Introduction



*Region II Small Business Subcontractor of the Year award. LeCroy also won the National Award in the same year.*

Business Subcontractor of the Year. The circumstances leading to this honor involved many years of close working relationship with Los Alamos National Laboratory, through appropriate products, close administrative support, rapid deliveries, and exemplary repair service.

It has also resulted in an award for serving the nation for excellence in Exports. In 1988, LeCroy received the coveted President's "E" Award, for excellence in Exports. At least half of LeCroy business originates outside of the U.S.A. A series of direct sales and service subsidiaries as well as competent distributors help carry LeCroy service philosophy to other areas of the world. Continued growth and success is a tribute to the influence of LeCroy's traditions and practices.

*The President's "E" Award for excellence in exports, recently awarded to LeCroy.*



Take a look at LeCroy. See a demo of a LeCroy instrument or system, rent a LeCroy scope or signal source, borrow one from a field engineer or borrow one from your neighbor. LeCroy instruments will not disappoint you.



## Justifying Digital Instruments

---

### Why Digital Instruments?

**In many ways, the practical benefits of digital instruments such as the digital oscilloscope over their analog counterparts can be demonstrated by comparison to the word processor's superiority over the typewriter.**

The word processor has never been price competitive to the typewriter. Then why do managers accept the new technology which is five to ten times more expensive than the traditional equipment? On the surface, the functions and applications are the same: the creation of documents. The answer is that word processing does MORE, offering capabilities which are either impossible for a typewriter to perform or that improve productivity. Similarly, while the functions of both kinds of scopes appear to be identical, ie., waveform recording, it is the added capability, generally leading to increased productivity, that justifies the premium of the digital technology.

As with the word processor, the digital oscilloscope achieves much of its power because it stores the information in memory. Once there, it can be viewed and processed as much as necessary to obtain the desired result.

Similar to the word processor's capturing a text document for operator editing and automated processing for spelling, formatting, or typesetting, the digital scope captures a waveform for operator manipulation (using expansion and cursors) and then automatically processes it to detect errors, extract precise measurement information, translate it into a format more readily understood, eliminate interference from random noise or known perturbations, and even make decisions (including generation of signals to control external equipment) based upon operator-entered standards or pre-loaded "golden" waveforms.

Just as with the word processor, digital scopes can operate in conjunction with magnetic disks or central computers for storage of information, maintaining frequently used settings of the equipment, or transferring applications between workcenters. Not to be forgotten is the printed output. The ability of a digital scope to transfer its waveform data or processed information to plotters, printers or desktop publishing systems greatly facilitates generation of reports, publications, and historical files of important work.

This practical analogy between the word processor and the digital oscilloscope carries further to the general role they play in the workplace. Compared to the typewriter, which requires highly specialized operators, the word processor (in the form of a personal computer) is a comprehensive tool for a broad range of applications that can be operated by individuals with responsibilities as different as typist or president, and with widely-separated skill or training levels.

So too with digital oscilloscopes. With their added power, they are able to replace a wide variety of conventional equipment that would otherwise require separate purchase and separate operator training. As important as the obvious economic aspects, these tools are available when they are needed. Typically the oscilloscope is used in problem-solving and investigative applications. The ready and convenient access that comes from having many functions in a single familiar instrument can make the difference between being able to find an answer or not, or can convert a week's project into a several minute task.

### Why LeCroy Digital Instruments?

**LeCroy digital instruments generally have characteristics which make them different, sometimes more expensive, and, frequently better.** Unlike instruments created by firms who for many years made the corresponding analog product, there is little tendency for LeCroy products to limit performance by emulating that of the traditional product (e.g. providing only 6 bits resolution or several percent accuracy), or to limit features, such as to protect the market for traditional products.

LeCroy digital instruments have their heritage in research laboratory instrumentation, where measurement fidelity, flexibility, fast signal processing, and remote control are primary requirements. This background has encouraged LeCroy to approach measurement problems from a direction that emphasizes capability and performance. LeCroy tries to make digital instruments do as much as they can possibly do, and do it better. The instruments frequently incorporate innovative features (trending, histogramming, SMART trigger, sequence mode, and long memories to name a few in oscilloscopes) which provide users with powerful new tools that extend the ease of use, accuracy, utility and productivity beyond that which is commonly available. Some benefits of this product philosophy follow.



# Introduction

## Multi-Function Capability

With traditional instruments, each function in a system requires a separate piece of equipment, additional operator training, and often complex means of interconnecting or systemizing the individual instruments.

**With digital instruments, the built-in memory and microprocessor(s) give them a unique ability to process data in different ways. Comparative functionality of Digital Oscilloscopes and Arbitrary Function Generators with conventional instruments is presented in the following table:**

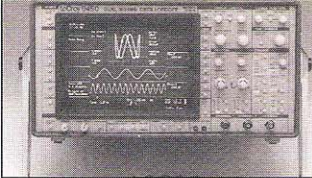
<b>A Digital Oscilloscope</b> has much of the functionality of:	
Instrument	Est. Cost
Real Time Storage Scope	\$ 7000
Sampling Scope	\$ 9000
Digital Voltmeter	\$ 500
AC Voltmeter	\$ 2000
Spectrum Analyzer	\$12000
Frequency Counter	\$ 2000
Scope Camera	\$ 300
Strip Chart Recorder	\$ 800
X-Y Recorder	\$ 800
Time Domain Reflectometer	\$15000
Network Analyzer	\$30000

One fast <b>AFG</b> has much of the functionality of:	
Instrument	Est. Cost
Function Generator	\$2500
Sinewave Generator	\$1600
Pulse Generator	\$3000
Protocol Analyzer	\$4000
Digital Word Generator	\$7200
Sweep Generator	\$4000
Frequency Synthesizer	\$7500

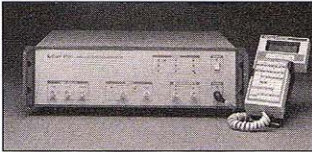
This flexibility allows one instrument to replace many, with substantial savings in investment, space, system complexity, software development, training, and maintenance.

## Productivity Gains



**A major contribution of digital instruments to productivity is made through their facilitation of automation.** Digital scopes and AFGs not only measure or generate signals via digital techniques, they are also fully digitally controllable and are optimized for use with digital computers for operational control and decision-making. While this does not usually eliminate the need for a human operator, automated or remote control increases the rate of testing considerably, and in some cases, is the only practical way to adequately exercise today's increasingly complex devices.

**In addition to being fast, automated instruments are tireless.** They happily perform the same measurements, without error, repeatedly day after day and are particularly well-suited to repetitive tasks that both consume and bore highly qualified personnel. There are many productivity gains that can be developed through improving quality or performing tasks with less expensive personnel.

Automated applications have traditionally been difficult and expensive to implement due to the many different instruments that were required and the complexity of programming them. Digital instruments offer a versatility that greatly simplifies the test system organization, and are supported by a wide variety of advanced software tools which significantly reduce system implementation time.



The following table highlights some of the features of LeCroy instruments that support automation and productivity gains.

## LeCroy Features that Enhance Automation and Productivity

**Built-in Signal Processing:** Many LeCroy digital instruments offer high speed processing (FFTs, averaging, pulse parameters, histogramming), designed to support rapid analysis and data collection with little or no operator programming or intervention.

**High-speed GPIB:** LeCroy high-speed data transfer software/hardware can achieve rates that are notably faster than other instruments (eg., 400 KB/s under actual laboratory conditions).

**Auto-setup:** Most LeCroy digital scopes can set their own controls based upon the signal received. This process simplifies programming and enables the instrument to capture and store signals with unknown characteristics.

**Familiar Panel:** LeCroy digital scopes look and operate like the analog scopes with which operators are familiar. This virtually eliminates initial training time, reduces errors, and makes it possible for these instruments to become general purpose equipment for both experienced and inexperienced people.

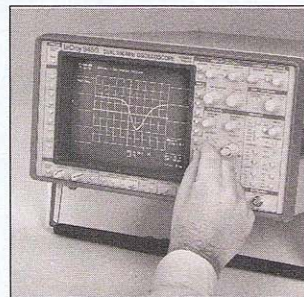

**High Performance:** High-frequency instruments are preferred in automated applications since they can more readily measure unanticipated worst-case conditions.

**Multichannel Capability:** Remote controlled test stands frequently require relatively large numbers of waveform acquisition and generation channels. The multichannel, often modular nature of LeCroy instruments is designed specifically to facilitate creation and operation of such systems.

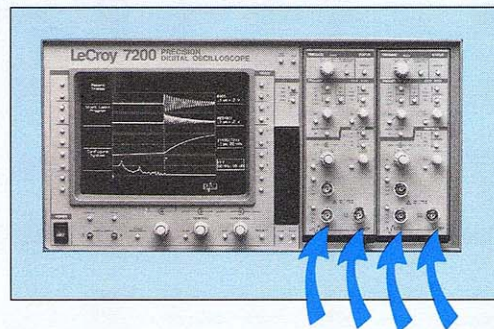

4 independent inputs

**Multiproduct Compatibility:** LeCroy products are designed to operate together, and facilities are provided for transferring data and set-ups between instruments, using common interfaces or hard copy devices.

**Software Support:** LeCroy T&M products are supported by an extensive library of LeCroy software products for control, analysis, archiving, and calibration that allow obtaining immediate results, often without programming. One doesn't have to spend weeks learning how to do traditionally complicated things, such as creating waveforms for an arbitrary function generator, automating a series of scope measurements or setting up an oscilloscope metrology workstation. In addition, there is also compatibility with a large selection of third party programs such as ASYST, Labwindows, Labview, ILS, WAVE, and Compuwave, that facilitate generation of custom programs.

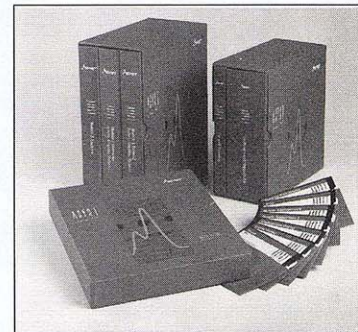



## Capability Gains

The increased capability offered by digital instruments allows the user to do things that are extremely difficult or impossible with traditional instruments. **The benefit can range from convenience (eg., being able to direct an image of a digital oscilloscope screen directly to a desktop publishing system to ease report generation), to changing the way in which measurements are made (eg., using arbitrary waveforms to exercise devices under test with a variety of worst-case signals).**

In many areas, the new capabilities provide the essential tools to take advantage of technological developments. A good example of this is a digital scope's ability to capture and display low-rate glitches. This is a critically important diagnostic tool for the development and testing of the ever-more complex digital circuits. Likewise, the ability of an AFG to create signals with glitches (or random noise) has become very important in the development of communications systems such as local area networks.

LeCroy digital instruments are distinctive in that they provide the broadest array of capability enhancing features as indicated by the table below:

### LeCroy Features that Provide Capability Gains

#### FEATURE vs. CAPABILITY GAIN

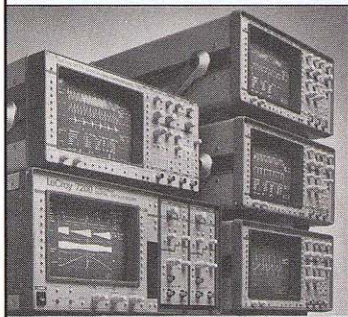

#### Digital Oscilloscopes

**Long Memories:** Protection against aliased results at slower timebases; X100 expansion; better time resolution; easier to capture transients.

**Sequence Mode:** Captures waveforms at highest rate; ideal for video; enables time resolved measurements.

**Dual Zoom:** Expand two sections of the same or different traces.

**Individual ADCs:** Simultaneous sampling on all channels; no reduced sampling rate with increase in channels.

**8-bit Resolution:** Four times the accuracy and dynamic range of 6 bits; <1% measurements.

**Enhanced Accuracy:** Up to 11 bits for transient signals at reduced bandwidth.

**Signal Averaging Modes:** Up to 14 bits for repetitive signals; optimize for accuracy or update rate.

**30-50K Point FFTs:** Higher frequency resolution.

**Vector Display:** Crisp, closest to analog-type display.

**Multi-trace Display:** View raw and processed data on same screen; overlay raw, processed or stored (reference) waveforms.

**Pulse Parameter/Cursor Measurements:** High accuracy measurements of amplitudes, times, delays, frequencies; on screen with trace.

**Waveform Math:** +, -, x, / different waveforms, integrate, differentiate, square root, log, etc.; on screen with trace.

**Chain Calculations:** Compound processing in real time (eg., average the FFT or FFT the average).

**Trigger:** Capture waveforms based upon pulse width (glitch), interval, state qualified, time/event qualified, or pattern criteria.

**Auto Save/Recall:** Record and playback up to last 2000 traces.

**Disks/DOS File:** No programming for MS-DOS machines; Structure personal waveform and setup disks; floppy distribution of scope enhancements.

**Autosequence:** Learned keystroke sequences automate frequent operations.

**Program Language:** Scope control language supports automated GO/NO-GO testing and decision making in instrument without external computer.

**Multi-media Output:** Plots screen on printers, plotters, and desk-top publishing systems.

**Statistics/trending:** Powerful analysis built in.

**High-speed Transfers:** >400 MB increases system throughput.

**Common GPIB Commands:** Control compatibility between instruments.



## LeCroy Features that Provide Capability Gains

### Arbitrary Function Generators

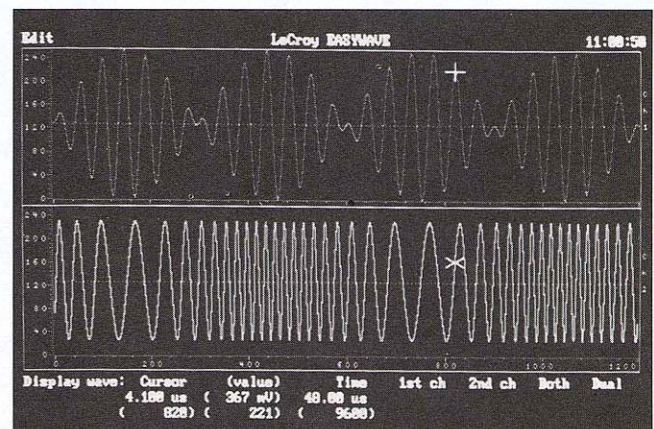
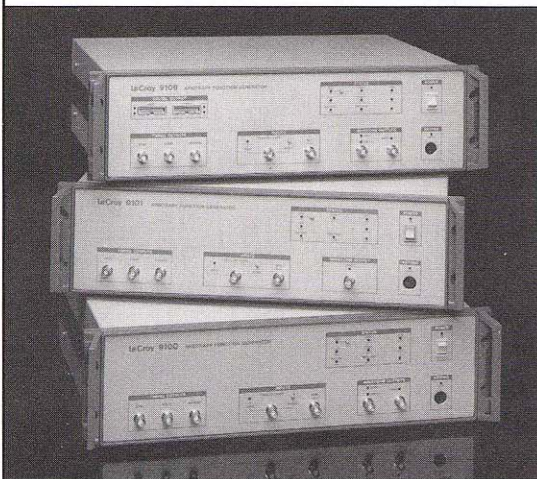

**Dual Channel:** Simultaneous testing; waveform mixing; differential signal output.

**Long Memory:** High fidelity reproduction of longer signals.

**Non-volatile Storage:** Enables immediate download without calculation or transfers.

**Waveform Linking:** Increases the effective waveform length to billions of points.

**Multiple Function:** Allows operation as pulse, function or arbitrary function generator.

**External Summing:** For mixing with other waveforms.

**Digital Outputs:** Generates high-speed digital sequences.

**EASYWAVE Software:** Simplifies creation of waveforms or digital patterns using either equations, library elements, spreadsheet editor, or transfer from a digital oscilloscope.

**Self Calibration:** Ensures high accuracy, < 1% for 8-bit, < 0.3% for 12-bit.

**Parameter Scaling:** Delay, frequency, amplitude and offset can all be rescaled in real time without editing memory data.

**Multiple Trigger Modes:** Provides unparalleled flexibility.

**Mixed Signal Outputs:** Analog and digital outputs are simultaneously available.

**Frequency Stability:** Crystal reference phase locked loop time base maintains frequency to 5 ppm.

**Digital Oscilloscope Compatibility:** Permits "single button" transfer of waveforms captured by LeCroy digital oscilloscopes.

**Low Harmonic Distortion:** Guarantees precise generation of high frequency signals.



# Introduction

## Economic Justification

Creating an economic justification for any piece of capital equipment generally involves balancing the true cost of ownership against the gains in productivity resulting from the use of the product.

**The true cost of ownership reflects all the costs associated with the product, including those incurred after delivery.** This calculation is also a useful method of comparing products on a cost basis. To arrive at the cost of ownership, estimate the following expenses and add them up. *(Note: Appendix H provides an example of the cost of ownership and productivity calculations)*

Equipment Cost	The basic cost of the equipment. If an instrument is multi-functional, then allowances need to be made to reflect the other instruments replaced. [See table on Page x]
+ Financing Charges	Typically 50% of purchase price if lease-purchased.
+ Maintenance Contracts	If required, can be up to 10-15% of purchase cost. [LeCroy has available post-warranty extended maintenance at 6% of the equipment cost per year]
+ Service Costs	Estimate of typical repair cost times the number of expected failures over the life of the product. [The reliability of digital instruments, spurred by requirements in the military, commercial and communications sectors, is extremely high. The long MTBF's enable LeCroy to offer longer (2 year) warranties].
+ Periodic Maintenance	Is calibration or calibration-confirmation required? If so, how often and by whom? Must the equipment leave the premises for simple confirmation of operation? The cost is the frequency of maintenance over the life of the product times the cost per event. [LeCroy digital instruments are self-calibrating and little, if any, periodic maintenance is required. For scope users required to certify traceability to NBS, LeCroy can provide this as a service or users can purchase the CALSOFT calibration package].
+ Lost Opportunity/ Business Interruption	Organizations suffer significant costs whenever equipment is down for maintenance. These costs are typically incurred for as long as the equipment is out of service, and this varies from day to weeks depending on the manufacturer. Costs may be calculated by considering one or more of: overtime premium for personnel, lost gross profit on lost revenues, direct and overhead costs added due to project delay, purchase of spare equipment. [LeCroy offers a guaranteed 2-day service turn-around plus yearly calibration and other services as part of its Blue Ribbon Service Plan available at a nominal cost].
+ Software Update Charges	Some manufacturers charge for bug-fix upgrades. [Covered in LeCroy warranty].
+ Personnel Training	Estimate of the time required for initial familiarization plus periodic refreshers, if necessary. [Digital instruments like LeCroy's, whose controls operate similarly the familiar analog counterparts greatly reduce time and cost of special training. LeCroy's products also go to great lengths to preserve software and operational compatibility between products, so experience with one instrument is easily transferred to the next].
+ Software Development	This is often one of the major costs of ownership for modern instruments. Like maintenance, it has both direct expense and lost opportunity costs associated with it. [LeCroy products minimize this investment by: <ul style="list-style-type: none"><li>■ Building many applications into the instruments (eg., FFT, waveform processing, pulse parameters, loading AFG waveforms from DSO acquisitions).</li><li>■ Maintaining compatibility with commercially developed signal processing and instrument control packages.</li><li>■ Providing LeCroy supported software packages that perform most of the device dependent operations.</li><li>■ Supporting users with technical "hot lines".</li></ul>
+ Product Life/Obsolescence	The useful life of high-performance equipment is determined in large part by when its design is overtaken by technology. Is the equipment state-of-the-art to begin with? Is it supported after sale with upgrades? Is it expandable? Is it modular so it can take advantage of future changes in technology? If a product exhibits a longer useful life, then its comparative cost of ownership is proportionally decreased. (For example, adding one year to a three year life extends the life by 33%, providing a significant reduction in the yearly costs). [LeCroy digital products reduce obsolescence by providing modularity which allows upgrading or expanding as requirements or technology changes, and through making available software upgrades which improve the future versatility.]

## Total Cost of Ownership



## Customer Service Information

---

### PRODUCT ASSISTANCE

Answers to questions concerning installation, calibration, and use of LeCroy equipment are available from your local field service office or from our Customer Services Department, 700 Chestnut Ridge Road, Chestnut Ridge, New York 10977-6499, (914) 425-2000.

If calling the factory, select the extension according to the following:

Digital Scopes (9400 Series): X3290  
Digital Scopes (7200 Series): X6042  
Wavecorder Systems: (7900 Series): X6015  
Signal Sources: X3180

### WARRANTY

LeCroy warrants its instrument products to operate within specifications under normal use and service for a period of one year from the date of shipment. Component products, replacement parts, and repairs are warranted for 90 days. This warranty extends only to the original purchaser. Software is thoroughly tested, but is supplied "as is" with no warranty of any kind covering detailed performance. Accessory products not manufactured by LeCroy are covered by the original equipment manufacturer's warranty only.

In exercising this warranty, LeCroy will repair or, at its option, replace any product returned to the factory or an authorized service facility within the warranty period, provided that the warrantor's examination discloses that the product is defective due to workmanship or materials and has not been caused by misuse, neglect, accident or abnormal conditions or operations.

The purchaser is responsible for the transportation and insurance charges arising from the return of products to the servicing facility. LeCroy will return all in-warranty products with transportation prepaid.

This warranty is in lieu of all other warranties, express or implied, including but not limited to any implied warranty of merchantability, fitness, or adequacy for any particular purpose or use. LeCroy will not be liable for any special, incidental, or consequential damages, whether in contract, or otherwise.

### SOFTWARE LICENSING AGREEMENT

Software products are licensed for a single machine. Under this license you may:

- Copy the software for backup or modification purposes in support of your use of the software on a single machine.
- Modify the software and/or merge it into another program for your use on a single machine.
- Transfer the software and the license to another party if the other party accepts the terms of this agreement and you relinquish all copies, whether in printed or machine-readable form, including all modified or merged versions.

### UNPACKING AND INSPECTION

LeCroy recommends that the shipment be thoroughly inspected immediately upon delivery. All material in the container(s) should be checked against the enclosed Packing List and shortages reported to the carrier promptly. If the

shipment is damaged in any way, please notify the carrier. If the damage is due to mishandling during shipment, you must file a damage claim with the carrier. The LeCroy field service office can help with this. LeCroy tests all products before shipping and packages all products in containers designed to protect against reasonable shock and vibration.

### SERVICE PROCEDURE

Products requiring maintenance should be returned to the factory or authorized service facility. If under warranty, LeCroy will repair or replace the product at no charge. The purchaser is only responsible for the transportation charges arising from return of the goods to the service facility.

For all LeCroy products in need of repair after the warranty period, the customer must provide a Purchase Order Number before any inoperative equipment can be repaired or replaced. The customer will be billed for the parts and labor for the repair as well as for shipping.

### RETURNS

All products returned for repair should be identified by the model and serial numbers and include a description of the defect or failure, name and phone number of the user. In the case of products returned, a Return Authorization Number is required and may be obtained by contacting the Service Office in your area. Any returned goods should be shipped in the original packaging material. Returned goods that have not been packed in the original packing material and have been damaged in shipping will not be repaired under warranty. Any goods returned for credit are subject to a 20% restocking charge.



---

# Introduction

---

## **LeCroy USA Service Offices:**

Chestnut Ridge, NY (914)578-6059  
Albuquerque, NM (505) 293-8100  
Pleasanton, CA (415) 463-2600  
Manassas, VA (703) 368-1033

## **LeCroy International Service Offices:**

Switzerland: LeCroy SA  
(022) 719.21.11  
West Germany: LeCroy GmbH  
(06221) 49162  
France: LeCroy SARL  
16.907.3897  
United Kingdom: LeCroy LTD  
(0235) 33114  
Italy: LeCroy S.r.l.  
(06) 302.96.46  
Belgium/Netherlands: LeCroy B.V.  
(04902) 89285

## **LeCroy Corporation Headquarters**

700 Chestnut Ridge Road  
Chestnut Ridge, NY 10977-6499 USA  
Tel: (914) 425-2000  
TWX: 710-577-2832

## **INNOVATIVE SERVICE AND EXTENDED WARRANTY OPTIONS FOR SUPERIOR PRODUCT SUPPORT**

- Blue Ribbon Service
- Extended Warranty
- Calibration
- Supplemental Support Agreement
- On-Call Repair Service
- Expedited Repair Service
- Installation and Training
- Training Seminars and Programs

Even the most advanced and sophisticated test instruments may suffer degraded performance if they are not properly maintained. Many LeCroy customers are well-satisfied by the LeCroy reputation for high quality and the standard warranty covering parts and labor. However, you may wish to implement additional service and

warranty provisions to ensure continued peak performance of your LeCroy instruments.

### **Calibration**

LeCroy, as well as most other manufacturers, recommends annual calibration of test instruments. Standard calibration certifies that LeCroy products meet all published specifications. Most waveform measurement products, including digital oscilloscopes, can be certified according to MIL-STD 45662 using sources traceable to the National Bureau of Standards.

### **Blue Ribbon Service**

- Guaranteed three-day turnaround on repairs
- Toll-free number for service assistance
- Extra instruction manual, prior to delivery

In applications where downtime is very critical, Blue Ribbon Service provides a guarantee of three-day turnaround on repair. If your repair cannot be completed within three days, a loan unit is shipped to you for use until the repairs are completed.

When you choose Blue Ribbon Service, you have toll-free, direct access to a service specialist in the local LeCroy service office.

Blue Ribbon Service provides you with an extra copy of the equipment manual, shipped immediately upon receipt of the equipment order. The opportunity to study the manual before arrival of the product often proves helpful in enabling immediate use of the product upon its receipt.

### **Extended Warranty**

- Fixed price for parts labor and return shipping
- Annual calibration
- Full standard warranty coverage
- Free implementation of design improvements

Extended Warranty is designed for customers who prefer to budget maintenance costs in advance and avoid additional paperwork when the original equipment warranty expires. It is usually implemented in increments of one year, and may be paid annually or quarterly.

When you purchase a multi-year contract, you receive fixed pricing for the length of the Extended Warranty.

Under the Extended Warranty, units may be shipped to LeCroy for annual calibration even if no repairs are needed. All other conditions and requirements of the standard LeCroy warranty apply. Standard calibration, certifying products to meet all published specifications, is provided at no charge. Certification of most waveform measurement products to meet MIL-STD-45662, using sources traceable to the National Bureau of Standards, can also be provided.

LeCroy will implement two top levels of engineering changes at no expense to you on equipment returned for service under Extended Warranty. Addition of the high-priority design improvements will help keep your units technically comparable to the latest production models.

### **Supplemental Support Agreement**

Supplemental Support is designed for customers who prefer to have direct LeCroy product support performed on



site. The basic plan provides up to 32-hours of on-site visits by LeCroy Technical Support Specialists per year. Additional visits may be provided at a quantity discount price. You may choose to allocate service time for installation, training, repair, addition of engineering changes, or preventive maintenance. There are no labor or travel charges for any Supplemental Support visit.

A Field Service Engineer will be available for on-site repair requests within less than 72-hours after LeCroy receives notification of equipment malfunction. You may request 48-hour or 24-hour response.

Parts needed for repair or engineering improvements are billed at standard rates unless the product is under warranty.

### **On-Call Repair Service**

If you do not have a service contract but need on-site service, you can rely on LeCroy On-Call Repair Service. On-site assistance by a factory-trained repairman can usually be provided within five working days from your request. The price of this service depends on travel costs, the length of time needed for the repair, and the cost of parts. For

products covered by warranty, there will be no charge for parts or labor time spent on site; however, you will be billed for travel time and expenses.

### **Expedited Repair Service**

Several options are offered by most LeCroy service-centers to give you the option of immediate repair turnaround. These service products increase the priority of your repair to as quickly as 24-hour response time as given below. Normal parts and labor charges are additional to the prices of these options, unless the repair item is under warranty. In many cases, your normal repair turnaround will achieve these times. However, as this is dependent upon existing workloads, the repair expedite options provide you the insurance that your unit is repaired ahead of others.

Expedite-1	24 hours
Expedite-2	48 hours
Expedite-3	72 hours
Expedite-5	5 days
Expedite-10	10 days

### **Installation and Training**

You should have no major difficulty operating LeCroy equipment using the documentation provided with each

product. However, if you want to get a new system running in a minimum amount of time, you may find the installation and training option especially useful. It provides the services of a LeCroy Field Service Engineer to help set up the system and provide instructions concerning its use.

Additional training courses covering operation, testing, maintenance, and repair are also available. The price for this service depends on the number of people attending a training course and its length.

### **Training Seminars and Programs**

Besides on-site installation and training associated with specific product purchases, LeCroy often holds training seminars at its main facilities or regional service centers. These seminars are announced in general mailings and newsletters, and an effort is made to send invitations to existing customers having purchased equipment related to the area being emphasized. These programs provide an ongoing opportunity for new or reassigned personnel within a facility to train off-site long after LeCroy equipment has been purchased.



## LeCroy Portable and Benchtop Digital Oscilloscopes

---

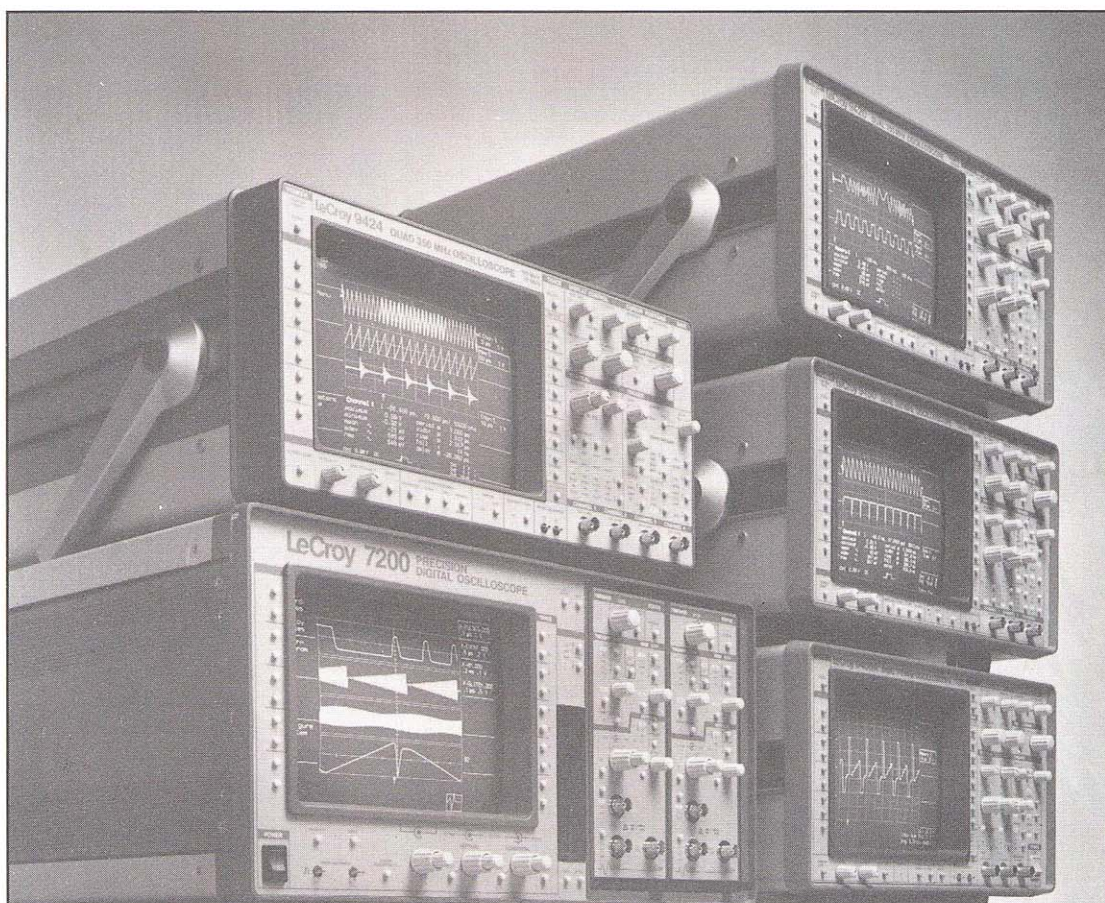

*Left Top:* Model 9424 Portable Four-Channel Digital Oscilloscope.

*Left Bottom:* 7200 Series Modular Digital Oscilloscope.

*Right Top:* Model 9420 Portable Dual-Channel Digital Oscilloscope.

*Right Middle:* Model 9450 Portable Dual-Channel Digital Oscilloscope.

*Right Bottom:* Model 9400A Portable Dual-Channel Digital Oscilloscope.



## Digital Oscilloscope Selection Guide

Model	9450	9424	9420	9400A	7200/4	7200/2
<b>Architecture</b>						
Total Channels	2	4	2	2	4	2
Hard Disk	N	N	N	N	Y	Y
Floppy Disk	N	N	N	Option	Y	Y
XY Display	Y	Y	Y	N	Y	Y
External Clock	Y	Y	Y	N	Y	Y
Remote Software	Y	Y	Y	Y	Y	Y
<b>Rate</b>						
Analog Bandwidth	350 MHz	350 MHz	350 MHz	175 MHz	400 MHz	400 MHz
Maximum Sample Rate	400 MS/s	100 MS/s	100 MS/s	100 MS/s	1 GS/s	1 GS/s
<b>Memories</b>						
Memory/Channel	50K	50K	50K	32K	50K	50K
Reference Memory	200K	200K	200K	64K	400K	400K
Memory Segmentation	Y	Y	Y	Y	Y	Y
<b>Signal Processing</b>						
Pulse Parameters	Y	Y	Y	N	Y	Y
+ - * /	Y	Y	Y	Opt	Y	Y
Averaging	Y	Y	Y	Opt	Y	Y
Trending	N	N	N	N	Y	Y
Histogramming	N	N	N	N	Y	Y
Window Functions	Opt	Opt	Opt	Opt	Y	Y
FFT	Opt	Opt	Opt	Opt	Y	Y
IFT	N	N	N	N	Y	Y
<b>Triggering Via</b>						
Amplitude	Y	Y	Y	Y	Y	Y
Slope	Y	Y	Y	Y	Y	Y
Bi-Slope	Y	Y	Y	Y	Y	Y
Pattern	Y	Y	Y	N	Y	Y
State Qualified	Y	Y	Y	N	Y	Y
Holdoff by Events	Y	Y	Y	N	Y	Y
Holdoff by Time	Y	Y	Y	N	Y	Y
Pulse Width	Y	Y	Y	N	Y	Y
Pulse Interval	Y	Y	Y	N	Y	Y
TV Trigger	Y	Y	Y	N	Y	Y
<b>Page Number</b>	1 - 4	1 - 12	1 - 8	1 - 23	1 - 40	1 - 40



## About Digital Oscilloscopes

---

### What Are the Advantages of Going Digital?

**Productivity:** Digital oscilloscopes bring new levels of productivity to engineers and scientists by providing waveform storage and measurement automation. Acquired waveforms are immediately stored in the oscilloscope's memory and transmitted to the screen for display. The memory storage allows continuous regeneration of the waveform on the screen; transient waveforms may be held indefinitely with no loss of intensity.

**Archiving:** Storage of signals also makes them available for subsequent recall and display, for comparison with other stored or live signals as well as for further processing and analysis. Screen and memory information can be directly read out on to a range of digital plotters and printers for instant hardcopy archiving.

**Automation:** You can also use a digital oscilloscope in computer automated testing applications. Full programmability allows control of the entire front-panel so that cumbersome sequences of measurements can be easily programmed and rapidly performed. LeCroy oscilloscopes also offer compatibility with waveform analysis, editing and generation packages such as EASYWAVE, ASYST and Catalyst software.

### What to Consider When Choosing a DSO

#### **BANDWIDTH: SINGLE SHOT OR REPETITIVE**

The bandwidth of an oscilloscope is defined as the frequency at which a reference signal is attenuated to 70.7% (-3 dB) of its original amplitude. High bandwidth is often described as being the most important specification of an oscilloscope. This statement should be used with caution when considering a digital instrument.

The bandwidth figure quoted by manufacturers usually refers to overall analog bandwidth. It is measured using repetitive signals. Repetitive signals allow the use of interleaved sampling techniques and subsequently allow higher equivalent sampling rates. For this oversampling (sample rate  $\gg$  Nyquist frequency), the oscilloscope can fully utilize its generally advertised bandwidth.

However, for digital oscilloscopes, it is also worthwhile to consider bandwidth conditions for single as well as repetitive signals. For single-shot (transient) phenomena, digital sampling theory implies that to capture and characterize a signal, more than two conversions must be made for each cycle of the signal's highest frequency component (often called the Nyquist frequency). This indicates that the maximum sampling rate will limit an instrument's usable single-shot bandwidth, (i.e., single-shot bandwidth  $\leq$  (maximum sample rate)/2).

For example, the LeCroy 7242 samples at 1 GS/s and has a single-shot bandwidth of 400 MHz. In contrast, sampling oscilloscopes have high repetitive-signal bandwidth but deliver very poor single-shot performance because they have a low single-shot sampling rate.

Thus, before selecting an oscilloscope on bandwidth criteria, you should examine both your single-shot and repetitive signal requirements.

#### **VERTICAL ACCURACY**

A number of factors contribute to the overall vertical accuracy of a digital oscilloscope. These include amplifier gain and offset accuracies as well as ADC accuracy. A limit on ADC accuracy is vertical resolution. Resolution is dependent on the number of bits used when the signal is digitized, i.e., a 6-bit ADC has  $2^6-1$  (63) discrete levels for a full scale signal. This means that the theoretical resolution would be 1.6% ( $1/63 \times 100$ ). Theoretical ADC resolution is only the best case limit of accuracy. Digital and analog noise, bandwidth effects and non-linearities all contribute to the degradation of the performance of the ADC.

Effective-bit and signal-to-noise ratio (SNR) specifications provide a simplified means of comparing oscilloscope performance at a particular frequency and signal amplitude. They combine the effects of most error sources into one specification. For example, the 9400A oscilloscope uses 8-bit ADCs which provide exceptionally high effective-bit rates (better than 7.0 bits, i.e. SNR = 41.9 dB, for a 50 MHz signal).

An oscilloscope's SNR is very important as it provides a true indication of how well you can detect small signals. Noise can bury (or mask) low amplitude signals, thereby negating the benefit of a high resolution ADC. Waveform averaging and digital filtering routines can reduce this noise and may extend resolution by several bits.



---

# Portable and Benchtop Digital Oscilloscopes

---

LeCroy oscilloscopes combine outstanding ADC performance with excellent overall DC accuracy, better than  $\pm 2\%$  (optional  $\pm 1\%$  for the model 9400A).

## LONG MEMORIES

Only long memories allow high fidelity recording in digital oscilloscopes. Long memories allow fast sampling rates (and therefore better timing resolution) on all time-base settings. Because of their long memories, LeCroy scopes can continue to sample at their highest rates (400 MS/s, 1 GS/s) even on relatively long time base settings. For repetitive signals, long memories help to maintain usable bandwidth at slower time base settings. Maintaining the fast sampling rate is essential for preventing aliasing errors. Fast sampling ensures accurate measurements on high-frequency signals (like rise time, fall time, pulse width etc.) .

Long memories also allow you to view more of your signal. Live, stored and processed waveforms can be expanded up to 1000 times (100 times for the model 9400A) to reveal glitches, spikes and high frequency signal components that oscilloscopes with short record lengths simply fail to capture!

Long memories can be segmented to allow sequential waveform storage, for multiple back-to-back acquisitions of single-shot phenomena. The technique minimizes the dead time between sequential acquisitions and preserves horizontal resolution. It is ideal for logging intermittent faults or monitoring randomly occurring phenomena.

## DISPLAY RESOLUTION

Providing accurate data means more than just acquiring it with quality ADCs. A clear, high-resolution display allows data to be analyzed with ease and precision such as in LeCroy DSO's. It also enables cursors (for time, voltage and frequency measurements) to be positioned with better accuracy. In LeCroy DSO's, an electronically generated grid removes parallax errors and requires no periodic adjustment. Setup and measurement information is presented around the edge of the grid, leaving it clear for many waveforms to be compared and analyzed simultaneously.

LeCroy oscilloscopes also feature a unique Min/Max display technique that provides built-in peak detection and shows the extremes (envelope) of a waveform. This technique creates a "painting" effect when displaying slow waveforms which have high frequency components. You immediately have a visual

indication that you can expand the waveform to reveal finer details in the signal.

## GETTING INSTANTANEOUS ANSWERS

To get the most from your oscilloscope, an extensive range of processing capabilities are available including arithmetic, square, square root, exponential, logarithm, integration, differentiation, smoothing, extrema and FFT's. For applications that require noise reduction or improved resolution LeCroy's averaging capabilities are faster and more flexible than in any other digital oscilloscope. For example, summation averaging can be performed on up to 1,000,000 signals at rates in excess of 100 waveforms per second (100,000 points per second). Even on single-shot waveforms, vertical resolution can be enhanced by as much as 3 bits using LeCroy's special low-pass filtering techniques.

LeCroy digital oscilloscopes also function as spectrum analyzers. Fast Fourier processing presents spectral information in an instant. Frequency constituents can be examined in terms of magnitude, power density and phase.

## ANALOG FEEL FOR FAMILIAR OPERATION

To help bridge the gap between analog and digital scopes, familiarity of operation is a critical consideration when choosing a DSO. LeCroy oscilloscopes are designed with a front-panel layout like an analog oscilloscope to ensure that you operate it intuitively from the very first moment. Rotary knobs and single function buttons allow fast and fine adjustments with ease. High speed processing emphasizes the analog feel, as waveforms are presented instantly on the display.

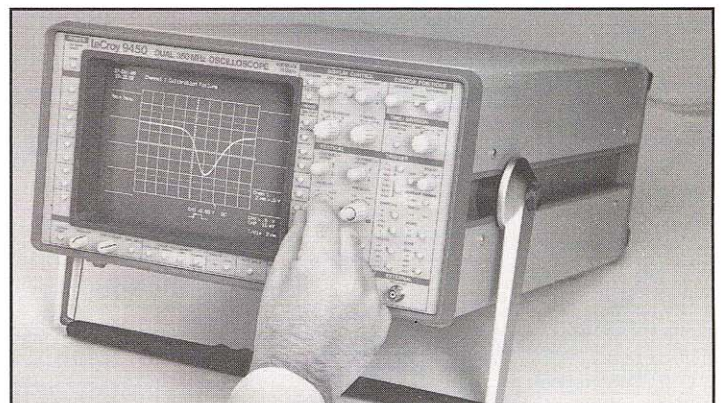



# Portable and Benchtop Digital Oscilloscopes

4/1/92 \$11,490  
Dev 2 weeks

## 9450 Portable Dual-Channel Digital Oscilloscope

### Main Features

- DC - 350 MHz Bandwidth
- 400 MS/s single shot sampling for transient signals
- 10 GS/s random interleaved sampling for repetitive signals
- High Fidelity 8-bit ADCs
- Non-volatile 50K Memories
- Segmentable Memories with Trigger Point Time Stamps
- FASTGLITCH Trigger Mode
- Pulse Parameters and Auto-setup
- Signal Processing and FFT Analysis
- TV Trigger and XY Display

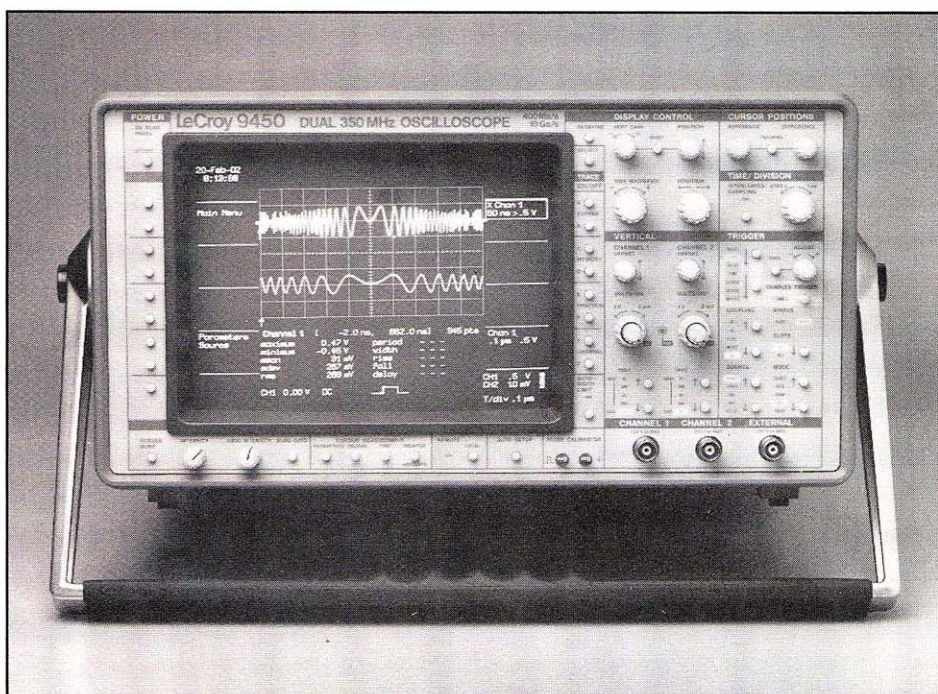

### The Ultimate for Design, Research and Test

The LeCroy 9450 Dual-channel Digital Oscilloscope is a powerful high-resolution instrument for waveform recording and sophisticated analysis. It combines high bandwidth, fast sampling rates, high fidelity, extensive trigger capabilities and signal processing. Aimed at meeting the demands of researchers and engineers working in fields as diverse as telecommunications, electronic design and test, lasers, computers, NDT, physics and defense, the 9450 will rapidly become an indispensable measurement tool in any laboratory. Like all LeCroy oscilloscopes, the 9450 is designed to serve as a range of different instruments: oscilloscope, transient recorder, counter/timer,

frequency meter, signal averager, data logger and digital voltmeter. It offers the highest performing data acquisition and processing system available in any portable instrument.

#### ANALOG FEEL, DIGITAL PRECISION

The 9450 employs Flash technology in its two high-resolution 8-bit ADCs (one per channel) which digitize waveforms with speed and precision. By integrating this technology with ease of use, LeCroy's portable instrument provides the best features of both analog and digital oscilloscopes.

The front-panel controls of the 9450 have been laid out in the style of an analog oscilloscope, making it easy to

use from the first moment. The analog feel is enhanced by the rapid instrument response and the fact that waveforms are presented instantly on a bright high-resolution screen. For automated test applications all front-panel controls, including cursor positions and internal functions, are fully programmable over RS-232C or GPIB interfaces.

Capturing and measuring signals has never been easier. For repetitive signals an auto-setup facility is available that will find and display signals in less than 2 seconds. For one-time phenomena the 9450's long 50K memories and its extensive triggering capabilities enable signals to be captured the very first time, even when signal speed and duration are uncertain.



# Portable and Benchtop Digital Oscilloscopes

## LONG NON-VOLATILE MEMORIES

Only long memories allow high-fidelity recording over extended periods of time. On equal time-base settings the 9450, with 50K of memory per channel, will sample waveforms up to 50 times faster than an oscilloscope with only 1K of memory. Faster sampling means better single-shot bandwidth, better time resolution and the power to expand waveforms up to 1000 times to see details that completely elude other digital oscilloscopes. In addition, when segmented, the 9450's non-volatile acquisition memories can store up to 200 waveforms/ channel (complete with date and time stamps).

## TRIGGER

Pushbutton control enables the user to choose the appropriate trigger functions for his signal: standard triggering for basic measurements and advanced triggering to meet highly sophisticated requirements.

The standard trigger facility provides all the conventional trigger functions. Front-panel controls select and adjust parameters such as pre- and post-trigger settings, trigger level, slope, mode and coupling. To help users quickly determine the 9450's trigger mode and conditions, LeCroy has created a series of illustrative trigger graphics.

SMART triggering offers a solution to even the most intricate triggering problems. For example, FASTGLITCH trigger can be used to locate and reveal glitches and spikes less than 2.5 nsec wide. Time-qualified trigger is ideal for ranging applications and can be used to ignore unwanted signal reflections. Other trigger features include hold-off (by time or number of events), gated triggering and conditional triggering, qualified trigger, and trigger delayed by time or number of events.

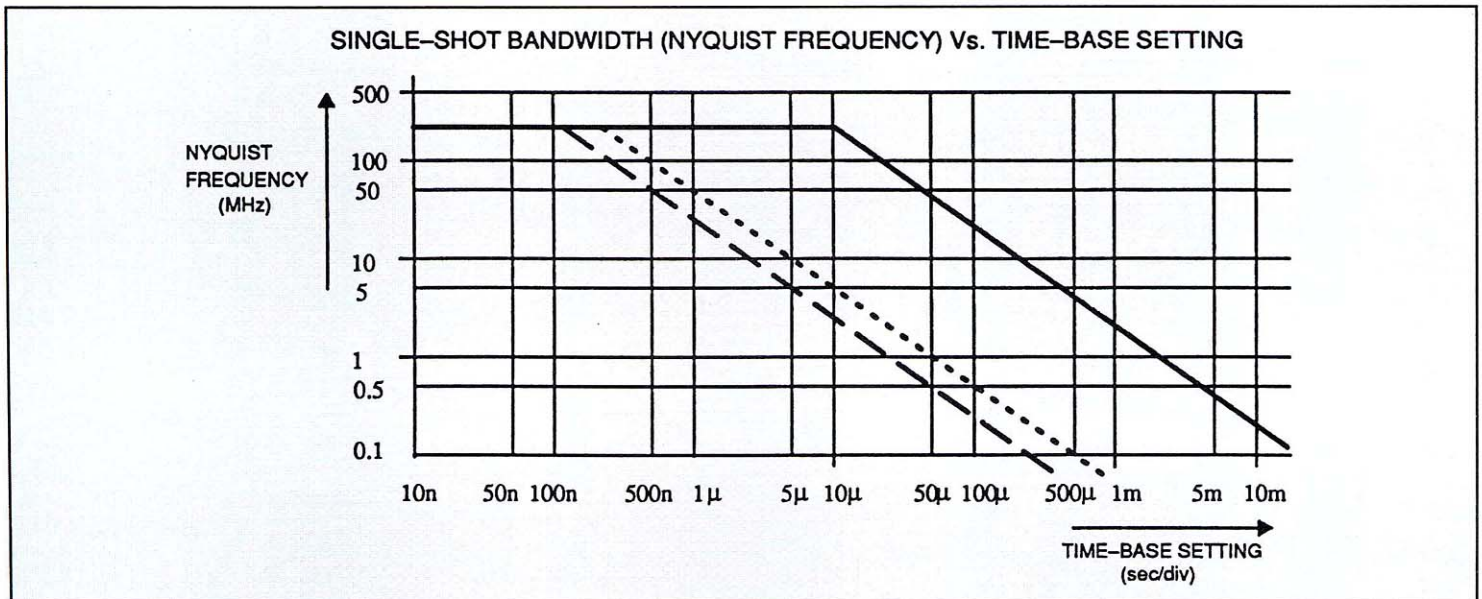

Single-shot bandwidth is a function of sampling rate. Long memories and LeCroy's patented compaction technique enable higher sampling rates at equal time-base settings. Above, the 9450 (solid line) is compared to oscilloscopes with 1K (dotted line) and 512 points (dashed line) of memory. At slower time-base settings, the single-shot bandwidth of the 9450, expressed as Nyquist frequency, is typically 50 times higher than in oscilloscopes with 1K memory and 100 times higher than in those with only 512 points.



## 9450 Specifications

### VERTICAL ANALOG SECTION

#### Bandwidth (-3 dB):

@ 50  $\Omega$ : DC to 350 MHz.

@ 1 M  $\Omega$  AC: < 10 Hz to 250 MHz typical at the probe tip.

@ 1 M  $\Omega$  DC: DC to 250 MHz typical at the probe tip.

**Input impedance:** 1 M $\Omega$  // 30 pF and 50  $\Omega$   $\pm$  1%.

**Channels:** Two independent channels; standard BNC connector inputs.

**Sensitivity range:** 5 mV/div to 2.5 V/div; continuously variable from 1 to 2.5 times the fixed setting. Fixed settings range from 5 mV/div to 1 V/div (in a 1, 2, 5 sequence).

**Vertical expansion:** up to 5 times (with averaging, up to 10 times or 500  $\mu$ V/div sensitivity).

**Scale factors:** Probe attenuation factors of X1, X10, X100, X1000, X10000 may be selected and are remotely programmable.

**Offset:**  $\pm$ 12 times the fixed sensitivity setting in 0.02 division increments up to  $\pm$ 10 V max.;  $\pm$ 24 div @ 10 mV/div;  $\pm$ 48 div @ 5 mV/div.

**DC accuracy:**  $\leq$   $\pm$  2%.

**Bandwidth limiter:** 80 MHz (-3 dB) typical.

**Max input voltage:** 250 V (DC + peak AC) at 1 M $\Omega$ ,  $\pm$  5 V DC (500 mW) or 5 V RMS at 50  $\Omega$ .

### VERTICAL DIGITAL SECTION

**ADCs:** One per channel, 8-bit Flash.

**Conversion rate:** Up to 400 megasamples/sec for transients, up to 10 gigasamples/sec for repetitive signals, simultaneously on both channels.

**Aperture uncertainty:**  $\pm$  10 psec.

**Acquisition memories, Channel 1 and 2:** Non-volatile memories (battery backed for a minimum of 2 years) of 50 kilowords per channel can be segmented into 2, 5, 10, 20, 50, 100 or 200 blocks.

**Reference memories, C and D:** 50K, 16-bit word memories which can store one acquired and/or processed waveform, or up to 200 waveforms when segmented.

**Function memories E and F:** Two 50K, 16-bit word memories for waveform processing.

**Peak and glitch detection:** Minimum and maximum peaks, as fast as 0.002% of the record length (minimum 2.5 nsec), are captured and displayed with 100% probability. Using LeCroy's new FASTGLITCH trigger technique (see the trigger section below), glitches faster than 2.5 nsec can be detected on all time-base settings.

### HORIZONTAL SECTION

#### Time Base

**Range:** 1 nsec/div to 5000 sec/div.

**Clock accuracy:**  $\leq$   $\pm$  0.01%.

**Interpolator resolution:** 5 psec.

**Sampling clock output:** BNC connector on rear panel.

**External clock in:** BNC connector on rear panel.

#### Acquisition Modes

**Random Interleaved Sampling (RIS)** for repetitive signals from 1 nsec/div to 5  $\mu$ sec/div.

**Single shot** for transient signals and repetitive signals from 10 nsec/div to 200 msec/div;

**Roll** for slowly changing signals from 500 msec/div to 5000 sec/div.

**Sequence** mode divides the acquisition memory into 2, 5, 10, 20, 50, 100, or 200 segments.

**Horizontal expansion:** DUAL ZOOM mode allows two different signals or two different sections of the same signal to be expanded up to 1000 times.

#### Trigger

**Pretrigger recording:** Adjustable in 0.2% increments to 100% of full scale (grid width).

**Post-trigger delay:** Adjustable in 0.02 division increments up to 10,000 divisions.

**External trigger input:** 1 M $\Omega$ , < 20 pF, 250 V max. (DC + peak AC).

**External trigger range:**  $\pm$  2 V in EXT,  $\pm$  20 V in EXT/10.

**Rate:** Up to 500 MHz using HF trigger coupling.

**Timing:** Trigger timing (date and time) is logged in the memory status menu. The timing of subsequent triggers in sequence mode is measured with 0.1 sec absolute resolution, or nanosecond resolution relative to the time of the first trigger.

**Trigger output:** BNC connector on rear panel.

**Trigger veto:** BNC connector on rear panel.

#### Standard Trigger

**Sources:** CHAN1, CHAN2, LINE, EXT, EXT/10. CHAN1, CHAN2 and EXT have independent trigger circuits allowing slope, coupling and level to be set individually for each source.

**Slope:** Positive, negative.

**Coupling:** HF, AC, LF REJ, HF REJ, DC

#### Modes:

**Auto:** Automatically re-arms after each sweep. If no trigger occurs, one is generated at an appropriate rate.

**Normal:** Re-arms after each sweep. If no trigger occurs after a reasonable length of time, the warning message "NO or SLOW TRIGGER" is displayed.

**Single (hold):** Holds display after a trigger occurs. Re-arms only when the "single" button is pressed again.

**Sequence:** Stores multiple events in segmented acquisition memories.

#### SMART Trigger

##### Single-source trigger modes:

**Hold-off by time:** 25 nsec to 20 sec.

**Hold-off by events:** 0 to 1,000,000,000 events.

##### Width-based trigger modes:

**Pulse width < (FASTGLITCH):** Triggers on opposite slopes of pulses narrower than a value between 2.5 nsec and 20 sec.

**Pulse width >:** Triggers on opposite slopes of pulses wider than a value in the range 2.5 nsec to 20 sec.

**Interval width <:** Triggers on similar slopes of signals narrower than a value in the range 10 nsec to 20 sec.

**Interval width >:** Triggers on similar slopes of signals wider than a value in the range 25 nsec to 20 sec.

##### Multi-source trigger modes:

**Pattern:** Triggers on the logic AND of the three sources CHAN1, CHAN2 and EXT, where each source can be defined as high (H), low (L) or don't



# Portable and Benchtop Digital Oscilloscopes

care (X). The trigger can be selected at the beginning (entered) or the end (exited) of the specified pattern.

**Bi-level:** This is a special condition of pattern trigger which allows the 9450 to trigger on any signal that exceeds a certain preset high or low trigger level.

**State qualified:** Allows the 9450 to trigger on any source (CHAN1, CHAN2 or EXT), while requiring that a certain pattern of the other two channels is present or absent. A delay by time or by number of events can be selected from the moment the pattern is valid.

**Time/Event qualified:** Allows the 9450 to trigger on any source (CHAN1, CHAN2 or EXT), as soon as a certain pattern of the three channels is entered or exited. From the moment of validity, a delay can be defined in terms of time or number of events.

**TV:** Allows stable triggering on TV signals that comply with PAL, SECAM or NTSC standards. Selection of both line and field number is possible. Active on EXT only.

## DISPLAY

**CRT:** 12.5 X 17.5 cm (5 X 7 inches); magnetic deflection; vector type.

**Resolution:** 4096 X 4096 points.

**Real-time clock:** Date, hours, minutes, sec.

**Grid:** Internally generated; separate intensity control for grid and waveforms. Single, dual and pulse parameter measurement grid mode.

**XY mode:** Plots any two sources (CHAN1 and 2, EXPAND A and B, Memories C and D and Functions E and F) against one another.

Operates on live waveforms with full cursor readout.

**Hard copy:** Single or multi-pen digital plotters as well as printers can be used to make hard copies of the display. Screen dumps are activated by a front-panel pushbutton or via remote control. Plotters supported are: the HP 7400 and 7500 series, Philips PM 8151, Graphtek FP 5301, and compatible models. Printers supported are: IBM, EPSON and the HP ThinkJet, QuietJet and LaserJet. Plotting can be done in parallel with normal 9450 operation.

## Cursors:

**Relative time:** Two cursors provide time measurements with a resolution of  $\pm 0.2\%$  of full scale for unexpanded traces; up to 10% of the sampling interval for expanded traces. The corresponding frequency information is also provided.

**Relative voltage:** Two horizontal bars measure voltage differences to  $\pm 0.2\%$  of full scale for each trace.

**Absolute time:** A cross-hair marker measures absolute voltage versus signal ground, as well as the time relative to the trigger.

**Absolute voltage:** A reference bar measures absolute voltage with respect to ground.

**Pulse parameters:** Two cross-hair cursors are used to define a region of interest for which pulse parameters will be calculated automatically.

**Graphics:** Waveforms and display information are presented using vector (linear) graphics. Expanded waveforms use LeCroy's DOT-LINEAR graphics that highlight actual data points and interpolate linearly between them.

**Menus:** Waveform storage; acquisition parameters; memory status; save/recall front-panel configurations; SMART trigger; waveform parameters, RS-232-C configuration; hardcopy setup and real-time clock setup, averaging, and arithmetic.

## AUTO-SETUP

Pressing the auto-setup button automatically scales the time-base, trigger and sensitivity settings to provide a stable display for a wide range of repetitive input signals.

**Type of signals detected:** Repetitive signals with amplitudes between 2 mV and 8 V, frequency above 50 Hz and a duty cycle greater than 0.1%.

**Auto-setup time:** Approximately 2 sec.

## WAVEFORM PROCESSING

Waveform processing routines are set up via menus. These include arithmetic functions (add, subtract and invert), and summation averaging (up to 1000 signals).

**Pulse parameters:** Based on ANSI/IEEE Std 181-1977 "Standard on Pulse Measurement and Analysis by Objective Techniques". The terminology is derived from IEEE Std 194-1977 "Standard Pulse Terms and Definitions".

## Automatic measurements determine:

Maximum	Period
Minimum	Pulse width
Mean	Risetime
Standard deviation	Falltime
RMS	Delay

**Sources:** CHAN1, CHAN2, MEMORY C or D, FUNCTION E or F, EXPANSION A or B. Cursors define the measurement zone. With more than 1 pulse present in the measurement zone, averaged results for period, width, risetime and falltime are presented.

## REMOTE CONTROL

Front-panel controls, including variable gain, offset, position controls and cursors, as well as all internal functions are programmable.

**RS-232C port:** For computer/terminal control or plotter connection. Asynchronous up to 19200 baud.

**GPIB port:** (IEEE-488). Configured as talker/listener for computer control and fast data transfer. Address switches on rear panel.

**Local/remote:** Remote control can be interrupted for local (manual) control at any time (except when in remote control with the lock-out state selected) by pushing a button on the front panel.

## PROBES

**Model:** Two P9020 (X10, 10 M $\Omega$  // 3.33 pF) probes supplied.

**Probe calibration:** 1 kHz square wave, 1 V p-p.

**Probe power:** Two rear-panel power outlets for use with active probes provide  $\pm 15$  V, + 5 V DC.

## SELF TESTS

**Auto-calibration** ensures accuracy of:

**Overall DC accuracy:**

$\pm 3\%$  full scale at 5 mV/div.

$\pm 2\%$  full scale at  $> 5$  mV/div.

**Time:** 20 psec RMS.

## GENERAL

**Temperature:** 5 to 40° C (41 to 104° F) rated; 0 to 50° C (32 to 122° F) operating.

**Humidity:**  $< 80\%$ .

**Power required:** 110 or 220 V AC, 45 to 440 Hz, 275 W.

**Battery backup:** Lithium batteries maintain front-panel settings and waveform data for 2 years.

**Dimensions:** (HWD) 19.2 X 36.5 X 46.5 cm, (7 1/2 X 14 3/8 X 18 3/8 inch).

**Weight:** 15 kg (33 lbs) net, 20 kg (44 lb) shipping.

**Warranty:** 2 years

## ORDERING INFORMATION

### Oscilloscope and Options

Code	Description
9450	Digital Oscilloscope
9450WP01	Waveform Processing Option
9450WP02	Fast Fourier Processing Option
9450M	CIIL/MATE Option
OM9450	Operator's Manual



## 9420 Portable Dual-Channel Digital Oscilloscope

### Main Features

- DC - 350 MHz Bandwidth
- 100 MS/s sampling for transient signals
- 10 GS/s random interleaved sampling for repetitive signals
- 8-bit Flash ADCs
- Non-volatile 50K Memories
- Segmentable Memories with Trigger Point Time Stamps
- Non-volatile Storage for Data and Settings
- FASTGLITCH Trigger Mode
- Pulse Parameters
- 1,000 X Waveform Expansion
- Built-in Processing: Waveform Mathematics and Averaging
- Auto-setup

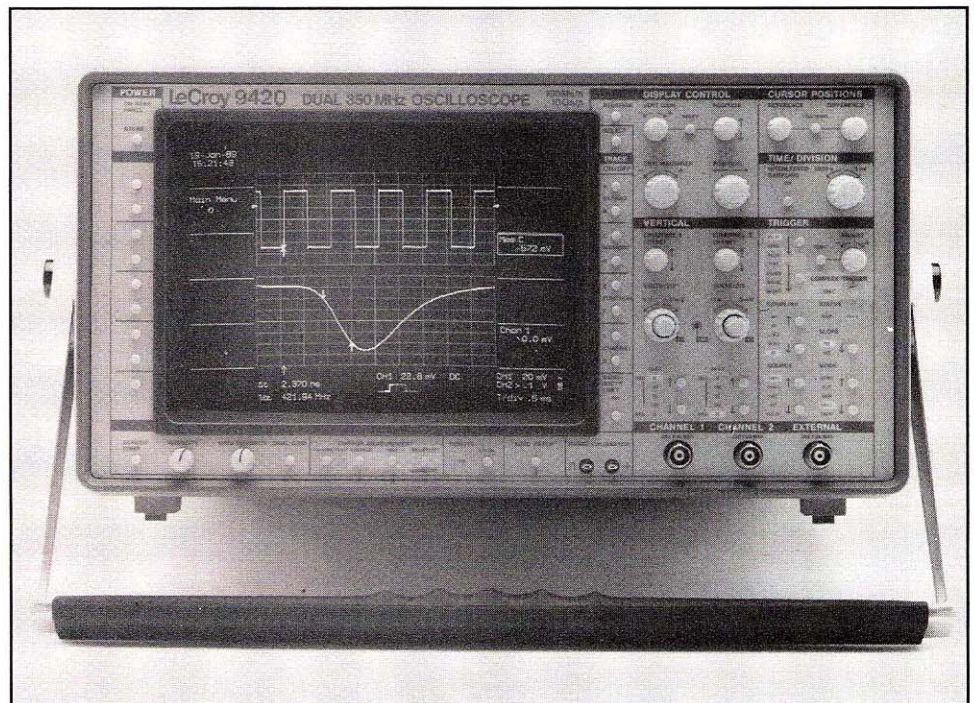

### Ideal for Design and Test Engineers

Combining all the features which have become standard in LeCroy oscilloscopes (speed, precision, long memories, extensive processing and ease of use), the 9420 is a cost effective instrument for high-frequency applications in areas such as electronics development, telecommunications, applied research, and automated testing. In replacing analog oscilloscopes, the 9420 provides high fidelity recording, measurement automation and extensive signal processing.

### SPEED, PRECISION and FIDELITY

Providing 8-bit (up to 12-bit with averaging) vertical resolution, superior dynamic performance, with very low noise, the 9420's Flash ADCs ensure measurement precision and fidelity. High 350 MHz bandwidth and fast sampling rates, up to 100 megasamples/sec for single events and 10 gigasamples/sec for repetitive signals, give the 9420 the speed required to handle current and future high-frequency applications. Waveforms are stored in long non-volatile memories which allow better

horizontal resolution, faster sampling rates and higher single-shot bandwidth for all time-base settings.

The front panel has been designed in the style of an analog oscilloscope, making it easy to use from the very first minute. Multi-processor technology enhances the analog feel and presents waveforms instantly on the bright high-resolution display. For automated test applications all the front-panel controls, including cursors and internal functions, are programmable over the RS-232C or GPIB ports.



## INNOVATIVE TRIGGERING

The 9420 features a trigger system which enables even the most elusive events to be captured. Each of the inputs (CHAN1, CHAN2 and EXT) has independent circuits which allow individual adjustment of the trigger level, slope and coupling. As a result, switching between trigger sources is fast and convenient. Simple push-button controls let the user select and adjust all the appropriate trigger parameters, such as pre- and post-trigger settings, trigger level, slope and coupling. Illustrative trigger graphics summarize the trigger configuration on the screen.

Other trigger features include FAST-GLITCH mode which can trigger on glitches or spikes less than 2.5 nsec wide even when they are buried in other complex signals. INTERVAL trigger mode can be used to trigger on rare phenomena, such as missing bits or drop-outs, in

long digital or analog data streams. By combining the three individual inputs, the 9420 can also perform logic and conditional triggering. STATE QUALIFIED, TIME/EVENT QUALIFIED and PATTERN trigger modes provide the versatility to cover a diverse range of design applications. Users can choose between triggering on entering or exiting a predetermined logic state, and can also specify the duration for which a particular condition must exist.

In SEQUENCE trigger mode the 9420's long memories can store up to 200 waveforms without the need for any other storage medium. A real-time clock associates each trigger with a date and time stamp to allow precise time measurements between events.

## ANSWERS IN AN INSTANT

Up to ten pulse and waveform parameters are rapidly and accurately calculated at the touch of a button. By positioning a set of cursors the user selects a region of interest or operates on the full 50,000 data points in live, stored or processed waveforms. All ten results are automatically recalculated after any front-panel adjustment or with each new waveform acquisition.

The 9420 also includes built-in arithmetic (add, subtract and invert) and summation averaging (up to 1000 waveforms) for situations that require noise reduction or improved dynamic range, sensitivity and vertical resolution. All computed answers can be read over the GPIB or RS-232C ports. Documentation of results is rapid and simple. All displayed information can be copied directly onto a variety of digital plotters and printers.

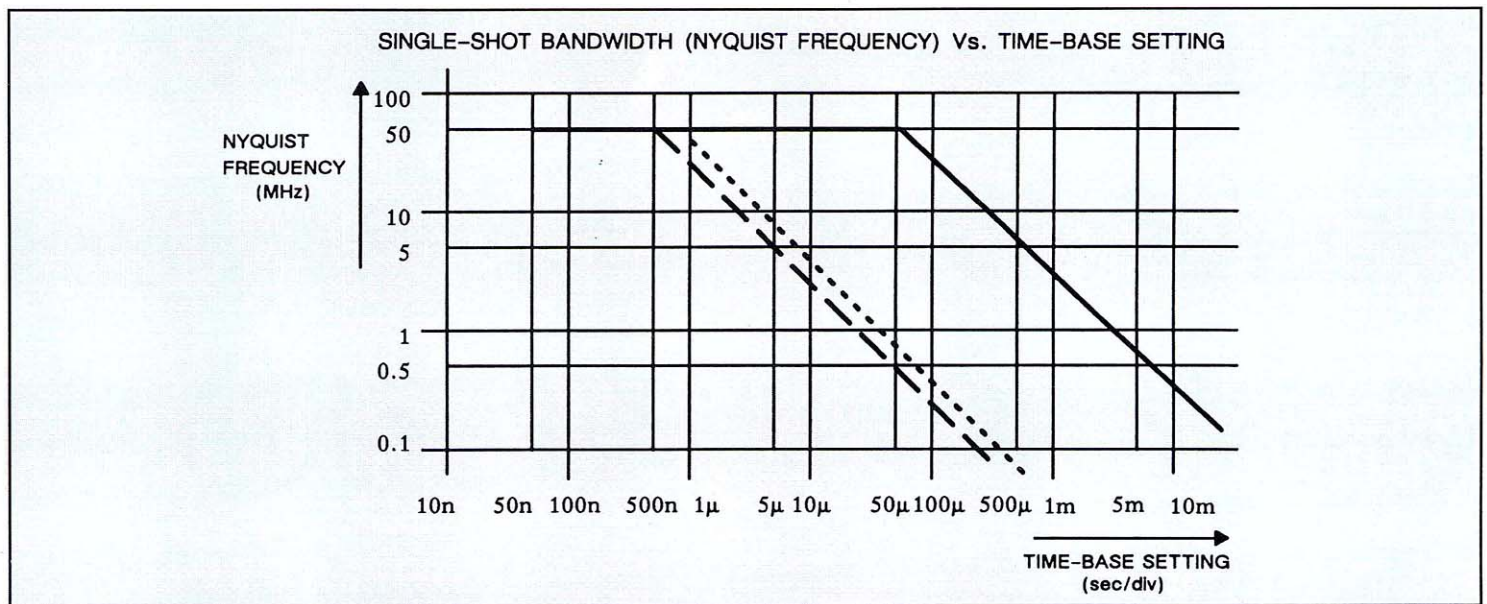

Single-shot bandwidth is a function of sampling rate. Long memories enable higher sampling rates at equal time-base settings. Above, the 9420 (solid line) is compared to oscilloscopes with 1K (dotted line) and 512 points (dashed line) of memory. At slower time-base settings, the single-shot bandwidth of the 9420, expressed as Nyquist frequency, is typically 50 times higher than in oscilloscopes with 1K memory and 100 times higher than in those with only 512 points.



# Portable and Benchtop Digital Oscilloscopes

## 9420 Specifications

### VERTICAL ANALOG SECTION

#### Bandwidth (-3 dB):

@ 50  $\Omega$ : DC to 350 MHz.

@ 1 M $\Omega$  AC: <10 Hz to 250 MHz typical at probe tip.

@ 1 M $\Omega$  DC: DC to 250 MHz typical at probe tip.

**Input impedance:** 1 M $\Omega$  // 30 pF and 50  $\Omega$   $\pm$  1%.

**Channels:** Two independent channels; standard BNC connector inputs.

**Sensitivity range:** 5 mV/div to 2.5 V/div; continuously variable from 1 to 2.5 times the fixed setting. Fixed settings range from 5 mV/div to 1 V/div (in a 1, 2, 5 sequence).

**Vertical expansion:** up to 5 times (with averaging, up to 10 times or 500  $\mu$ V/div sensitivity).

**Scale factors:** Probe attenuation factors of X1, X10, X100, X1000 and X10000 may be selected and are remotely programmable.

**Offset:**  $\pm$ 12 times the fixed sensitivity setting in 0.02 division increments up to  $\pm$  10 V max.;  $\pm$  24 div @ 10 mV/div;  $\pm$  48 div @ 5mV/div.

**DC accuracy:**  $\leq$   $\pm$  2%.

**Bandwidth limiter:** 80 MHz (-3 dB) typical.

**Max Input voltage:** 250 V (DC + peak AC) at 1 M $\Omega$ ,  $\pm$  5 V DC (500 mW) or 5 V RMS at 50  $\Omega$ .

### VERTICAL DIGITAL SECTION

**ADCs:** One per channel, 8-bit Flash.

**Conversion rate:** Up to 100 megasamples/sec for transients, up to 10 gigasamples/sec for repetitive signals, simultaneously on both channels.

**Aperture uncertainty:**  $\pm$  10 psec.

**Acquisition memories, Channels 1 and 2:** Non-volatile memories (battery backed for a minimum of 2 years) of 50 kilowords per channel can be segmented into 2, 5, 10, 20, 50, 100 or 200 blocks.

**Reference memories C and D:** 50K, 16-bit word memories which store one acquired or processed waveform, or up to 200 segmented waveforms.

**Function Memories E and F:** Two 50K, 16 bit word memories for waveform processing.

### Peak and glitch detection

Minimum and maximum peaks, as fast as 0.002% of the record length (minimum 10 nsec), are captured and displayed with 100% probability.

Using LeCroy's new FASTGLITCH trigger technique (see the trigger section below), glitches faster than 2.5 nsec can be detected on all time-base settings.

### HORIZONTAL SECTION

#### Time Base

**Range:** 1 nsec/div to 5000 sec/div.

**Clock accuracy:**  $\leq$   $\pm$  0.01%.

**Interpolator resolution:** 5 psec.

**Sampling clock output:** BNC connector on rear panel.

**External clock:** BNC connector on rear panel.

#### Acquisition Modes

**Random Interleaved Sampling (RIS)** for repetitive signals from 1 nsec/div to 20  $\mu$ sec/div.

**Single shot** for transient signals and repetitive signals from 50 nsec/div to 200 msec/div.

**Roll** for slowly changing signals from 500 msec/div to 5000 sec/div.

**Sequence** mode divides the acquisition memory into 2, 5, 10, 20, 50, 100, or 200 segments.

**Horizontal expansion:** DUAL ZOOM mode allows two different signals or two different sections of the same signal to be expanded up to 1000 times.

#### Trigger

**Pre-trigger recording:** Adjustable in 0.2% increments to 100% of full scale (grid width).

**Post-trigger delay:** Adjustable in 0.02 division increments up to 10,000 divisions.

**External trigger input:** 1 M $\Omega$ , < 20 pF, 250 V max. (DC + peak AC).

**External trigger range:**  $\pm$  2 V in EXT,  $\pm$  20 V in EXT/10.

**Rate:** Up to 500 MHz using HF trigger coupling.

**Timing:** Trigger timing (date and time) is listed in the memory status menu. The timing of subsequent triggers in sequence mode is

measured with 0.1 sec absolute resolution, or nanosecond resolution relative to the time of the first trigger.

**Trigger output:** BNC connector on rear panel.

**Trigger veto:** BNC connector on rear panel.

#### Standard Trigger

**Sources:** CHAN1, CHAN2, LINE, EXT, EXT/10 have independent trigger circuits allowing slope, coupling and level to be set individually for each source.

**Slope:** Positive, negative.

**Coupling:** HF, AC, LF REJ, HF REJ, DC.

#### Modes:

**Auto:** Automatically re-arms after each sweep. If no trigger occurs, one is generated at an appropriate rate.

**Normal:** Re-arms after each sweep. If no trigger occurs after a reasonable length of time, the warning message "No or Slow Trigger" is displayed.

**Single (hold):** Holds display after a trigger occurs. Re-arms only when the "single" button is pressed again.

**Sequence:** Stores multiple events in segmented acquisition memories.

#### SMART Trigger

##### Single-source trigger

##### operational modes:

**Hold-off by time:** 25 nsec to 20 sec.

**Hold-off by events:** 0 to 10<sup>9</sup> events.

##### Width-based trigger modes:

##### Pulse width < (FASTGLITCH):

Triggers on opposite slopes of pulses narrower than a value in the range 2.5 nsec to 20 sec.

**Pulse width >:** Triggers on opposite slopes of pulses wider than a value in the range

2.5 nsec to 20 sec.

**Interval width <:** Triggers on similar slopes of signals narrower than a value in the range 10 nsec to 20 sec.

**Interval width >:** Triggers on similar slopes of signals wider than a value in the range 25 nsec to 20 sec.

##### Multi-source trigger operational modes:

**Pattern:** Triggers on the logic AND of CHAN1, CHAN2 and EXT, where each



# Portable and Benchtop Digital Oscilloscopes

source can be defined as high (H), low (L) or don't care (X). The trigger can be selected at the beginning (entered) or at the end (exited) of the specified pattern.

**Bi-level:** This is a special condition of pattern trigger which allows the 9420 to trigger on any signal that exceeds a certain pre-set high or low trigger level. The signal must be connected simultaneously to two channels. The third trigger channel must be set to don't care (X).

**State qualified:** Allows the 9420 to trigger on any source (CHAN1, CHAN2 or EXT), while requiring that a certain pattern of the other two channels is present or absent. In addition a delay by time or by number of events can be selected from the moment the pattern is valid.

**Time/Event qualified:** Allows the 9420 to trigger on any source (CHAN1, CHAN2 or EXT), as soon as a certain pattern of the three channels is entered or exited. From the moment of validity, a delay can be defined in terms of time or number of events.

**TV:** Allows stable triggering on TV signals that comply with PAL, SECAM or NTSC standards. Selection on both line and field number is possible. Active on EXT only.

## DISPLAY

**CRT:** 12.5 X 17.5 cm (5 X 7 inches); magnetic deflection; vector type.

**Resolution:** 4096 X 4096 points.

**Real-time clock:** Date, hours, minutes, seconds.

**Grid:** Internally generated; separate intensity control for grid and waveforms. Single, dual and pulse parameter measurement grid mode.

**XY mode:** Plots any two sources (CHAN1, CHAN2, EXT, MEMORY C or D, FUNCTION E or F and EXPAND A and B against one another. Operates on live waveforms with cursor readout.

**Hard copy:** Single or multi-pen digital plotters as well as IBM, HP QuietJet, HP ThinkJet, HP LaserJet and EPSON printers can be used to make hard copies of the display. Screen dumps are activated by a front-panel button or via remote control. Plotters supported are: the HP 7400 and 7500 series, Philips PM 8151, Graphtek FP 5301, and compatible models. Plotting is done in parallel with normal 9420 operation.

**Graphics:** All waveforms and display information are presented using vector (linear) graphics. Expanded waveforms use LeCroy's

DOT-LINEAR graphics that highlight actual data points and interpolate linearly between them.

**Menus:** Waveform storage; acquisition parameters; memory status; save/recall front-panel configurations; SMART trigger; waveform parameters, RS-232C configuration; hardcopy setup and real-time clock setup, averaging, and arithmetic.

## Cursors

**Relative time:** Two cursors provide time measurements with a resolution of  $\pm 0.2\%$  of full scale for unexpanded traces; up to 10% of the sampling interval for expanded traces. The corresponding frequency information is also provided.

**Relative voltage:** Two horizontal bars measure voltage differences to  $\pm 0.2\%$  of full scale.

**Absolute time:** A cross-hair marker measures absolute voltage versus signal ground, as well as the time relative to the trigger.

**Absolute voltage:** A reference bar measures absolute voltage with respect to ground.

**Pulse parameters:** Two cross-hair cursors are used to define a region of interest for which pulse parameters will be calculated automatically.

## AUTO-SETUP

Pressing the auto-setup button automatically scales the time-base, trigger and sensitivity settings to display a wide range of repetitive input signals.

**Type of signals detected:** Repetitive signals with amplitudes between 2 mV and 8 V, frequency above 50 Hz and a duty cycle greater than 0.1%.

**Auto-setup time:** Approximately 2 sec.

## WAVEFORM PROCESSING

Waveform processing routines are called and set up via menus. These include arithmetic functions (add, subtract and invert), and summation averaging (up to 1000 signals).

**Pulse parameters:** Based on ANSI/IEEE Std 181-1977 "Standard on Pulse Measurement and Analysis by Objective Techniques". The terminology is derived from IEEE Std 194 - 1977 "Standard Pulse Terms and Definitions".

### Automatic measurements determine:

Maximum	Period
Minimum	Pulse width
Mean	Risetime
Standard deviation	Falltime
RMS	Delay

**Sources:** CHAN1, CHAN2, MEMORY C or D, FUNCTION E or F, EXPAND A or B. Cursors define the measurement zone. When more

than one pulse is present in the measurement zone, averaged results for period, width, risetime and falltime are presented.

## REMOTE CONTROL

Front-panel controls, including variable gain, offset, position controls and cursors, as well as all internal functions are programmable.

**RS-232C port:** For computer/terminal control or plotter connection. Asynchronous up to 19200 baud.

**GPIB port:** (IEEE-488). Configured as talker/listener for computer control and fast data transfer. Address switches on rear panel.

**Local/remote:** Remote control can be interrupted for local (manual) control at any time (except when in remote control with the lock-out state selected) by pushing a button on the front panel.

## PROBES

**Model:** Two P9010 (X10, 10 M $\Omega$  // 3.33 pF) probes supplied.

**Probe calibration:** 1 kHz square wave, 1 V p-p.

**Probe power:** Two rear-panel power outlets for use with active probes provide  $\pm 15$  V, + 5 V DC.

## SELF TESTS

**Auto-calibration** ensures accuracy of:

**Overall DC accuracy:**  $\pm 2\%$  full scale;

**Time:** 20 psec RMS.

## GENERAL

**Temperature:** 5 to 40° C (41 to 104° F) rated; 0 to 50° C (32 to 122° F) operating.

**Humidity:** < 80%.

**Power Required:** 110 or 220 V AC, 45 to 440 Hz, 275 W.

**Battery Backup:** Lithium batteries maintain front-panel settings and waveform data for 2 years.

**Dimensions:** (HWD) 19.2 X 36.5 X 46.5 cm, (7 1/2 X 14 3/8 X 18 3/8 inch).

**Weight:** 15 kg (33 lbs) net, 20 kg (44 lb) shipping.

**Warranty:** 2 years

## ORDERING INFORMATION

### Oscilloscope and Options

Code	Description
9420	Digital Oscilloscope
9420WP01	Waveform Processing Option
9420WP02	Fast Fourier Processing Option
9420M	CIIL/MATE Option
OM9420	Operator's Manual



## 9424 Portable Quad-Channel Digital Oscilloscope

### Main Features

- Four Channels with 350 MHz Bandwidth
- 50K of Non-volatile Memory per Channel
- FASTGLITCH Trigger Mode
- Pulse Parameters and Auto-setup
- TV Trigger and XY Display Mode
- Signal Processing and FFT Analysis

### Functional Description

The LeCroy 9424 offers a breakthrough in digital oscilloscope technology, combining 350 MHz bandwidth, 50K of non-volatile acquisition memory per channel, advanced triggering capabilities and digital design, the instrument offers many advantages over traditional multi-channel oscilloscopes. Independent 8-bit ADCs (for each channel) sample repetitive waveforms at up to 10 gigasamples/sec (single-shot phenomena at up to 100 megasamples/sec) to enable measurements with better timing resolution and precision. Extensive signal processing (including pulse parameters, averaging, mathematics and FFT analysis) performs complex measurements in a fraction of a second. Hard copies can be made directly over RS-232C or GPIB onto a wide range of digital plotters and printers.

#### ACCURACY AND PRECISION

Using the latest ideas in digital technology the Model 9424 features the speed and precision that have become standard in all LeCroy oscilloscopes. Waveforms are digitized by independent

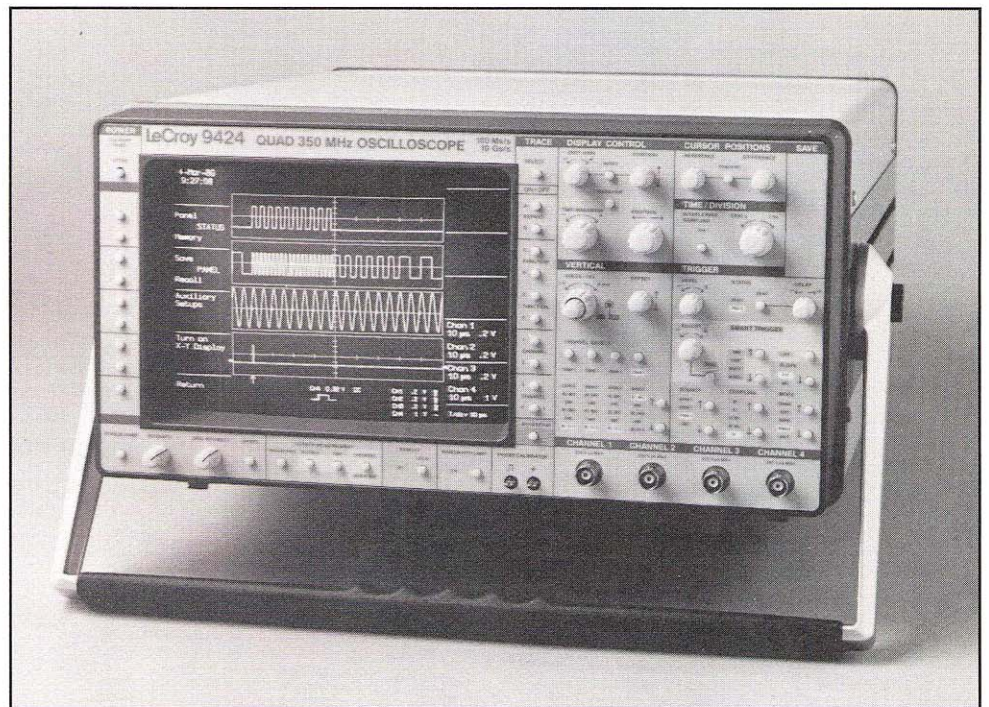

8-bit (12-bit with averaging) Flash ADCs that provide a high signal-to-noise ratio and superior dynamic resolution. Sampling rates of up to 10 gigasamples/sec are available for repetitive signals and up to 100 megasamples/sec for transient signals.

Each channel of the 9424 features a massive 50K of non-volatile acquisition memory for easy waveform capture, better horizontal resolution and fast sampling rates on **all** time-base settings.

#### ADVANCED TRIGGERING

The 9424 features the most advanced trigger system available in any four-

channel oscilloscope. Each of the inputs (Channel 1, 2 and 4) has independent circuits to allow individual adjustment of the trigger level, slope and coupling.

Simple push-button controls and rotary knobs let the user select and adjust all the appropriate trigger parameters, such as hold-off or pre- and post-trigger settings, with ease and precision. Unique trigger graphics summarize the trigger configuration at a glance.



# Portable and Benchtop Digital Oscilloscopes

Tracking rare glitches, spikes, missing bits and drop-outs is easy using the 9424's FASTGLITCH or INTERVAL trigger modes. Both modes can be used to provide stable triggering on even the most troublesome phenomena. For television or video development and test the 9424 includes a TV Trigger facility that is ideal for use on NTSC, PAL or SECAM systems. Triggering on lines and fields enables jitter-free viewing (and expansion) of any portion of a TV signal under investigation.

High-speed logic testing is effortless using the 9424's PATTERN trigger mode. Logic status on three inputs may be simultaneously examined enabling

the 9424 to trigger on entering or exiting any predefined pattern. Users can even specify the length of time for which a pattern must remain valid before allowing a trigger to occur.

For conditional triggering applications the 9424 includes both STATE QUALIFIED and TIME/EVENT QUALIFIED modes of operation.

## FOUR CHANNEL PROCESSING

For situations that require noise reduction or improved dynamic range the 9424 includes summation averaging (up to 1000 waveforms) simultaneously over four channels. Built-in arithmetic (add,

subtract and invert) and pulse parameter measurements are also standard. Up to 10 parameters can be automatically calculated on live, stored or processed waveforms.

Computations are made using high-speed processing so that values appear instantly on the screen. Additional processing power can be added by installing LeCroy's waveform processing options. WP02 performs spectral analysis and WP01 provides waveform characterization and extended mathematical analysis (integration, differentiation, etc.) as well as averaging.

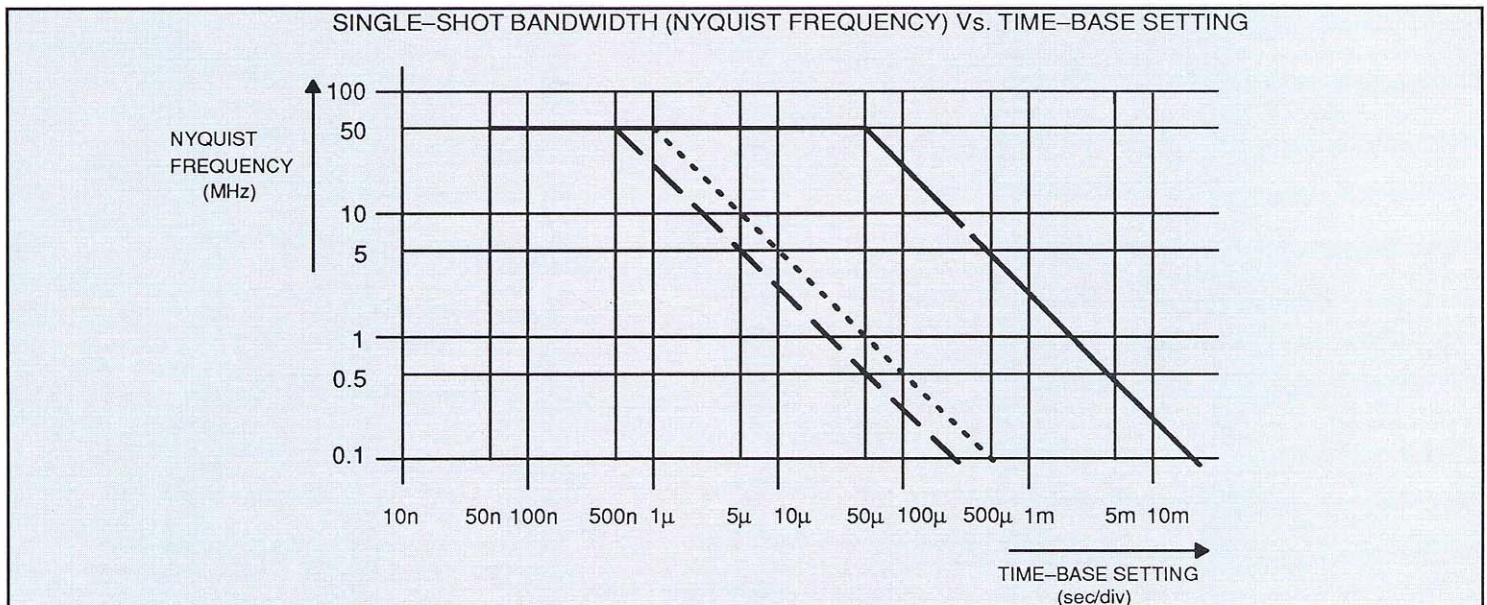

Single-shot bandwidth is a function of sampling rate. Long memories enable higher sampling rates at equal time-base settings. Above, the 9424 (solid line) is compared to oscilloscopes with 1K (dotted line) and 512 points (dashed line) of memory. At slower time-base settings, the single-shot bandwidth of the 9424, expressed as Nyquist frequency, is typically 50 times higher than in oscilloscopes with 1K memory and 100 times higher than in those with only 512 points.



# Portable and Benchtop Digital Oscilloscopes

## 9424 Specifications

### VERTICAL ANALOG SECTION

#### Bandwidth (-3 dB):

@ 50  $\Omega$ : DC to 350 MHz.

@ 1 M $\Omega$  AC: < 10 Hz to 250 MHz typical at the probe tip.

@ 1 M $\Omega$  DC: DC to 250 MHz typical at the probe tip.

**Input impedance:** 1 M $\Omega$  // 30 pF and 50  $\Omega$   $\pm$  1%.

**Channels:** Four independent channels; standard BNC connector inputs.

**Sensitivity range:** 5 mV/div to 2.5 V/div; continuously variable from 1 to 2.5 times the fixed setting. Fixed settings range from 5 mV/div to 1 V/div (in a 1, 2, 5 sequence).

**Vertical expansion:** up to 5 times (with averaging, up to 10 times or 500  $\mu$ V/div sensitivity).

**Scale factors:** Probe attenuation factors of X1, X10, X100, X1000 or X10000, may be selected and are remotely programmable.

**Offset:**  $\pm$  12 times the fixed sensitivity setting in 0.02 division increments up to  $\pm$  10 V max;  $\pm$  24 div @ 10 mV/div;  $\pm$  48 div @ 5 mV/div.

**DC accuracy:**  $\leq$   $\pm$  2%.

**Bandwidth limiter:** 80 MHz (-3 dB) typical.

**Max Input Voltage** 250 V (DC + peak AC) at 1 M $\Omega$   $\pm$  5 V DC (500 mW) or 5 V RMS at 50  $\Omega$ .

### VERTICAL DIGITAL SECTION

**ADCs:** One per channel, 8-bit Flash.

**Conversion rate:** Up to 100 megasamples/sec for transients, up to 10 gigasamples/sec for repetitive signals, simultaneously on all channels.

**Aperture uncertainty:**  $\pm$  10 psec.

#### Acquisition memories, Channel 1, 2, 3

**and 4:** Non-volatile memories (battery backed for a minimum of 2 years) of 50 kilowords per channel can be segmented into 2, 5, 10, 20, 50, 100 or 200 blocks.

**Reference memories, C and D:** 50K, 16-bit word memories, each storing one acquired or processed waveform, or up to 200 segmented waveforms.

**Function memories E and F:** Two 50K, 16-bit word memories for waveform processing.

#### Peak and Glitch Detection

Minimum and maximum peaks as fast as 0.002% of the record length (minimum 10 nsec) are captured and displayed with 100% probability.

Using LeCroy's new FASTGLITCH trigger technique (see the trigger section below), glitches faster than 2.5 nsec can be detected on all time-base settings.

### HORIZONTAL SECTION

#### Time Base

**Range:** 1 nsec/div to 5000 sec/div.

**Clock accuracy:**  $\pm$  0.01%.

**Interpolator resolution:** 5 psec.

**Sampling clock output:** BNC connector on rear panel.

**External clock input:** BNC connector on rear panel.

#### Acquisition Modes

**Random Interleaved Sampling (RIS)** for repetitive signals from 1 nsec/div to 20  $\mu$ sec/div.

**Single shot** for transient signals and repetitive signals from 50 nsec/div to 200 msec/div.

**Roll** for slowly-changing signals from 500 msec/div to 5000 sec/div.

**Sequence** mode divides the acquisition memory into 2, 5, 10, 20, 50, 100, or 200 segments.

**Horizontal expansion:** MULTI ZOOM mode allows different signals or different sections of the same signal to be expanded up to 1000 times.

#### Trigger

**Pre-trigger recording:** Adjustable in 0.2% increments to 100% of full scale (grid width).

**Post-trigger delay:** Adjustable in 0.02 division increments up to 10,000 divisions.

**Rate:** Up to 500 MHz using HF trigger coupling.

**Timing:** Trigger timing (date and time) is listed in the memory status menu. The timing of subsequent triggers in sequence mode is measured with 0.1 sec absolute resolution, or nanosecond resolution relative to the time of the first trigger.

**Trigger output:** BNC connector on rear panel.

**Trigger veto:** BNC connector on rear panel.

#### Standard Trigger

**Sources:** CHAN1, CHAN2, CHAN4, LINE. CHAN1, CHAN2 and CHAN4 have independent trigger circuits allowing slope, coupling and level to be set individually for each source. (CHAN3 is used for TV trigger).

**Slope:** Positive, negative.

**Coupling:** HF, AC, LF REJ, HF REJ, DC.

#### Modes:

**Auto:** Automatically re-arms after each sweep. If no trigger occurs, one is generated at an appropriate rate.

**Normal:** Re-arms after each sweep. If no trigger occurs after a reasonable length of time, the message "No or Slow Trigger" is displayed.

**Single (hold):** Holds display after a trigger occurs. Re-arms only when the "single" button is pressed again.

**Sequence:** Stores multiple events in segmented acquisition memories.

#### SMART Trigger

##### Single-source trigger operational modes:

**Hold-off by time:** 25 nsec to 20 sec.

**Hold-off by events:** 0 to 10<sup>9</sup> events.

##### Width-based trigger modes:

**Pulse width < (FASTGLITCH):** Triggers on opposite slopes of pulses narrower than a value in the range 2.5 nsec to 20 sec.

**Pulse width >:** Triggers on opposite slopes of pulses wider than a value in the range 2.5 nsec to 20 sec.

**Interval width <:** Triggers on similar slopes of signals narrower than a value in the range 10 nsec to 20 sec.

**Interval width >:** Triggers on similar slopes of signals wider than a value in the range 25 nsec to 20 sec.

##### Multi-source trigger operational modes:

**Pattern:** Triggers on the logical AND of CHAN1, CHAN2 and CHAN4, where each source can be defined as high (H), low (L) or don't care (X). The trigger can be selected at the beginning (entered) or at the end (exited) of the specified pattern.

**Bi-level:** This is a special condition of pattern trigger which allows the 9424 to trigger on any signal that exceeds a certain pre-set high or low trigger level. The signal must be connected simultaneously to two channels. The third trigger channel must be set to don't care (X).

**State qualified:** Allows the 9424 to trigger on any source (CHAN1, CHAN2 or CHAN4), while requiring that a certain pattern of the other two channels is present or absent. In addition a delay by time or by number of



# Portable and Benchtop Digital Oscilloscopes

events can be selected from the moment the pattern is valid.

**Time/Event qualified:** Allows the 9424 to trigger on any source (CHAN1, CHAN2 or CHAN4), as soon as a certain pattern of the three channels is entered or exited. From the moment of validity, a delay can be defined in terms of time or number of events.

**TV:** Allows stable triggering on TV signals that comply with PAL, SECAM or NTSC standards. Selection of both line and field number is possible. Active on CHAN3 only.

## DISPLAY

**CRT:** 12.5 X 17.5 cm (5 X 7 inches); magnetic deflection; vector type.

**Resolution:** 4096 X 4096 points.

**Real-time clock:** Date, hours, minutes, seconds.

**Grid:** Internally generated; separate intensity control for grid and waveforms. Single, dual, quad and pulse parameter measurement grid mode.

**XY mode:** Plots any two sources (CHAN 1, CHAN2, CHAN3, CHAN4, MEMORY C or D, FUNCTION E or F and EXPAND A and B against one another. Operates on live waveforms with cursor readout.

**Hard copy:** Single or multi-pen digital plotters as well as IBM, HP QuietJet, HP ThinkJet, HP LaserJet and EPSON printers can be used to make hard copies of the display. Screen dumps are activated by a front-panel button or via remote control. Plotters supported are: the HP 7400 and 7500 series, Philips PM 8151, Graphtek FP 5301, and compatible models. Plotting is done in parallel with normal 9424 operation.

**Graphics:** All waveforms and display information are presented using vector (linear) graphics. Expanded waveforms use LeCroy's DOT-LINEAR graphics that highlight actual data points and interpolate linearly between them.

**Menus:** Waveform storage; acquisition parameters; memory status; save/recall front-panel configurations; SMART trigger; waveform parameters, RS-232C configuration; hardcopy setup and real-time clock setup, averaging, and arithmetic.

## Cursors

**Relative time:** Two cursors provide time measurements with a resolution of  $\pm 0.2\%$  of

full scale for unexpanded traces; up to 10% of the sampling interval for expanded traces. The corresponding frequency information is also provided.

**Relative voltage:** Two horizontal bars measure voltage differences to  $\pm 0.2\%$  of full scale.

**Absolute time:** A cross-hair marker measures absolute voltage versus signal ground, as well as the time relative to the trigger.

**Absolute voltage:** A reference bar measures absolute voltage with respect to ground.

**Pulse parameters:** Two cross-hair cursors are used to define a region of interest for which pulse parameters will be calculated automatically.

## AUTO-SETUP

Pressing the auto-setup button automatically scales the time base, trigger and sensitivity settings to display a wide range of repetitive input signals.

**Type of signals detected:** Repetitive signals with amplitudes between 2 mV and 8 V, frequency above 50 Hz and a duty cycle greater than 0.1%.

**Auto-setup time:** Approximately 2 sec.

## WAVEFORM PROCESSING

Waveform processing routines are called and set up via menus. These include arithmetic functions (add, subtract and invert), and summation averaging (up to 1000 signals).

**Pulse parameters:** Based on ANSI/IEEE Std 181-1977 "Standard on Pulse Measurement and Analysis by Objective Techniques". The terminology is derived from IEEE Std 194-1977 "Standard Pulse Terms and Definitions".

## Automatic measurements determine:

Maximum	Period
Minimum	Pulse width
Mean	Risetime
Standard deviation	Falltime
RMS	Delay

**Sources:** CHAN1, CHAN2, CHAN3, CHAN4, EXPAND A or B. Cursors define the measurement zone. When more than one pulse is present in the measurement zone, averaged results for period, width, risetime and falltime are given.

## REMOTE CONTROL :

All internal functions and front panel controls are programmable.

**RS-232C port:** For computer/terminal control or plotter connection. Asynchronous up to 19200 baud.

**GPIB port:** (IEEE-488). Configured as talker/listener for computer control and fast data transfer. Address switches on rear panel.

**Local/remote:** By front panel push button.

## PROBES

**Model:** Four P9020 (X10, 10 M $\Omega$  //3.33 pF) probes supplied.

**Probe calibration:** 1 kHz square wave, 1 V p-p.

**Probe power:** Two rear-panel power outlets provide  $\pm 15$  V, + 5 V DC.

## SELF TESTS

**Auto-calibration** ensures accuracy of:

**DC accuracy:**  $\pm 2\%$  full scale > 5 mV/div  
 $\pm 3\%$  full scale at 5 mV/div

**Time:** 20 psec RMS.

## GENERAL

**Temperature:** 5 to 40° C (41 to 104° F) rated; 0 to 50° C (32 to 122° F) operating.

**Humidity:** < 80%.

**Power required:** 110 or 220 V AC, 45 to 440 Hz, 275 W.

**Battery backup:** Lithium batteries maintain front-panel settings and data for 2 years.

**Dimensions:** (HWD) 19.2 X 37.0 X 49.5 cm, (7 1/2 X 14 1/2 X 19 1/2 inches).

**Weight:** 15 kg (33 lbs) net, 20 kg (44 lb) shipping.

**Warranty:** 2 years

## ORDERING INFORMATION

9424	Digital Oscilloscope
9424WP01	Waveform Processing Option
9424WP02	Fast Fourier Processing Option
OM9424	Operator's Manual



# WP01 Waveform Processing Firmware for 9450/20/24 Digital Scopes

## Main Features

- Averaging  
Summation and Continuous
- Arithmetic - including Addition,  
Subtraction, Ratio and Multiplication
- Functions - including Integration,  
Differentiation, Log, Exp, ABS and  
Square Root
- Extrema Mode - Storage of Extreme  
Positive and Negative Values
- High-Resolution Mode for 11-bit  
Performance

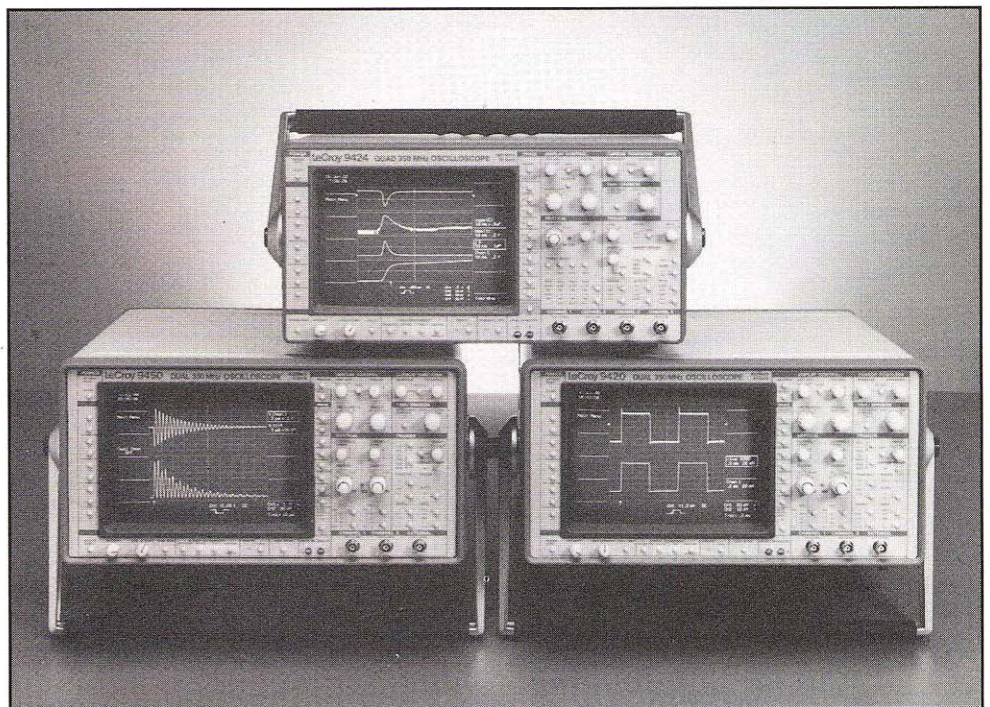

## For Signal Characterization and Analysis

The LeCroy WP01 Waveform Processing package offers powerful routines that extend the processing capabilities of the Models 9420, 9424 and 9450 Digital Oscilloscopes. All processing is built in to eliminate the need for external computers and controllers. High-speed microprocessors are used to ensure that computed waveforms are displayed instantly on the screen. The package is fully programmable over the GPIB or RS-232C interface and hard copies can be directly made on a wide range of digital plotters or printers.

*Added as a factory option or retrofitted in the field, the WP01 Waveform Processing Package adds high-speed averaging, filtering and mathematical capabilities to the Models 9420, 9424 or 9450 digital oscilloscopes.*

## Functional Description

The WP01 waveform processing package for the Models 9420, 9424 and 9450 Digital Oscilloscopes is optimized for processing signals in real time. A powerful 68020 microprocessor and 68881 co-processor enable very rapid representation of results such as averages, integrations, exponentials and multiplications.

Waveform operations can be performed on live, stored, processed or expanded waveforms. They are selected through

simple menus that allow functions to be chained together allowing more complex computations. For example, it is possible to perform the integration of an averaged waveform or the multiplication of a differentiated waveform.

All processing occurs in function memories E and F (C, D, E and F for the Model 9424) which may be displayed on the screen by simply pressing the appropriate function button. Processing is fully automatic and is simultaneous whenever more than one function has been selected.



## SIGNAL AVERAGING

WP01 offers two powerful, high-speed averaging modes that can be used to reduce noise and improve the signal-to-noise ratio. Vertical resolution can be extended by several bits to improve dynamic range and increase the overall input sensitivity to as much as 500  $\mu$ V/division.

Summed Averaging consists of the repeated addition (with equal weight) of recurrences of the selected source waveform. The number of acquisitions averaged can be selected between 2 and 1,000,000 sweeps with the accumulation automatically stopping when the number is reached. Signals exceeding the range of the oscilloscope's ADC can be automatically rejected to ensure valid summed averaging results.

The user may choose to "dither" the programmable offset of the input amplifier after each acquisition. Dithering uses slightly different portions of the ADC for successive waveforms so that the differential non-linearities are also averaged. As a result, in low-noise applications, the measurement precision and dynamic range are improved.

Continuous Averaging, sometimes called exponential averaging, is the repeated weighted average of the source wave-

form with the previous average. Averaging goes on indefinitely with each new acquisition and the effect of previous waveforms gradually tends to zero. Relative weighting factors can be chosen from 1:1 to 1:127. The method is particularly useful for monitoring noisy signals which may change slowly over a period of time.

## HIGH RESOLUTION

The WP01 package provides a selective filtering technique that improves vertical resolution for reduced bandwidth applications. By effectively removing high-frequency noise, with digital smoothing functions, waveforms can be analyzed with resolution from 8 to 11 bits. The technique can be used with both single-shot and repetitive signals and provides an ideal method for smoothing transient phenomena.

## EXTREMA MODE

Tracking rare glitches or monitoring signals drifting in time and amplitude is made easy with EXTREMA mode. EXTREMA waveforms are produced by repeatedly comparing acquisitions of a source waveform with a stored waveform that contains previous maximum and/or minimum excursions. Whenever a given data point of a new acquisition exceeds the existing data

point of the stored waveform, the old data point is replaced by the new. In this way the envelope of all waveforms is accumulated for up to a maximum of 1,000,000 sweeps.

## ARITHMETIC

WP01 offers basic arithmetic operations such as addition, subtraction, division and multiplication. These arithmetic functions can be performed on any source waveform on a point by point basis. Different vertical gains and offsets of the source waveforms are automatically taken into account in the computed result.

## MATHEMATICAL FUNCTIONS

Functions including differentiation, integration, square, square root, logarithm (base 10 and e), exponential and absolute value may be performed on any source waveform. The waveforms may be multiplied by a constant factor or offset by a constant. Arithmetic and mathematical functions can also be chained together to construct more complex processing routines.



# Portable and Benchtop Digital Oscilloscopes

## 9450/20/24 WP01 Specifications

complex processing routines.

### SUMMATION AVERAGING

**Number of sweeps:** 1 to 1,000,000.  
**Number of input points:** 50 to 50,000.  
**Offset dithering:** only on acquisition channels; ON/OFF.  
**Artifact rejection:** ON/OFF.  
**Vertical expansion:** 10 X maximum.  
**Maximum sensitivity:** 500  $\mu$ V/div after vertical expansion.  
**Speed:** up to 300,000 words/sec.

### CONTINUOUS AVERAGING

**Possible weighting factors:** 1:1, 1:3, 1:7, 1:15, 1:31 and 1:127.  
**Number of input points:** 50 to 50,000.  
**Vertical expansion:** 10 X maximum.  
**Maximum sensitivity:** 500  $\mu$ V/div after vertical expansion.

### ARITHMETIC

Identity, negation and reciprocal of any waveform. Addition, subtraction, multiplication, and ratio on any two waveforms.  
**Number of input points:** 50 to 50,000.  
**Multiplicative constant on first input:** from  $0.001 \times 10^{-33}$  to  $999.999 \times 10^{33}$ .  
**Additive constant on first input:** from  $-999.999 \times 10^{33}$  to  $999.999 \times 10^{33}$ .  
**Vertical expansion:** 5 X maximum.

### FUNCTIONS

Integration, differentiation, square, square root, logarithm and exponential (base e and 10).  
**Number of input points:** 50 to 50,000.  
**Multiplicative constant on input:** from  $0.001 \times 10^{-33}$  to  $999.999 \times 10^{33}$ .  
**Additive constant on input:** from  $-999.999 \times 10^{33}$  to  $999.999 \times 10^{33}$ .  
**Vertical expansion:** 5 X maximum.

### HIGH RESOLUTION

Choice of four low-pass filters for vertical resolution improvement from 8 to 11 bits at reduced bandwidth.  
**Vertical expansion:** 10 X maximum.  
**Maximum sensitivity:** 500  $\mu$ V/div after vertical expansion.  
**Maximum bandwidth (for 11 bit resolution):**  
RIS mode: 80 MHz.  
Single-shot mode: 3.2 MHz (9450), 800 kHz (9420 and 9424).  
**Speed:** from 50 kilowords/sec up to 300 kilowords/sec.

### EXTREMA

Logs all extreme values of a waveform over a programmable number of sweeps. Maxima and minima can be displayed together, or separately by choosing ROOF or FLOOR

traces.

**Number of sweeps:** 1 to 1,000,000.  
**Number of input points:** 50 to 50,000.  
Glitches as short as 0.002% of the time base (down to 2.5 nsec for the 9450, 10 nsec for the 9420 and 9424) are displayed.  
**Vertical expansion:** 5 X maximum.

### CHAINING OF OPERATIONS

Two functions can be automatically chained using Functions E and F (four functions in the 9424). Using memory C and D for intermediate results, any number of operations can be chained manually or via remote control.

### REMOTE CONTROL

All controls and waveform processing functions are fully programmable using the oscilloscope's GPIB or RS-232-C interfaces. Simple English-like commands are used.

### STORED FRONT PANELS

Up to 7 front-panel setups, including WP01 settings, can be stored in non-volatile memory and recalled using the menu buttons at the left side of the screen or via remote control.

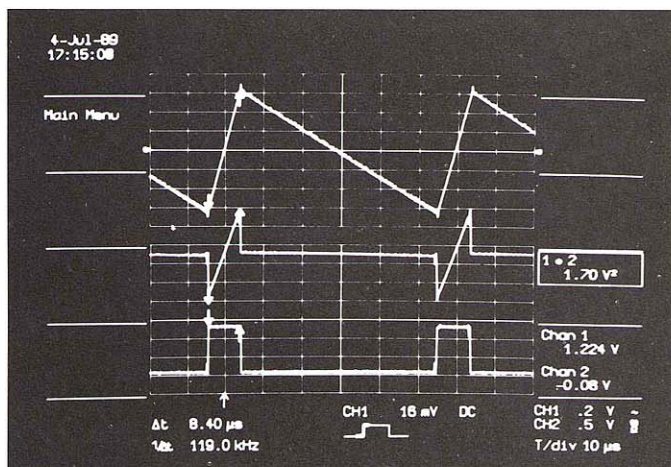

Whether it's sophisticated functions (like integration, differentiation or logarithm) or simple mathematics (like addition, subtraction and multiplication), the WP01 package can calculate the results with just a touch of a button. Above, a ramp (top trace) and a square wave (lower trace) are multiplied together. The result is shown in the middle trace complete with cursor readout.

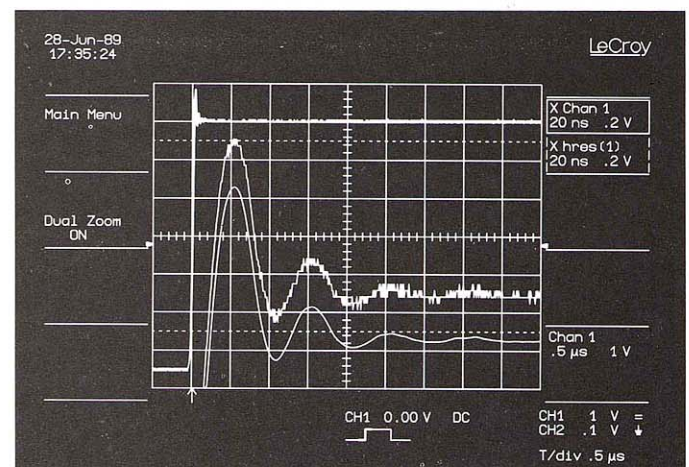

The WP01 package performs digital filtering techniques that allow improved vertical resolution and sensitivity. The above example shows the ringing on a step response (top trace) expanded 5 times vertically and 25 times horizontally (middle trace). The lower trace shows the same expansion but with 9-bit resolution. The second and third oscillations are now clearly visible.



## WP02 Spectrum Analysis Firmware for 9450/20/24 Digital Scopes

### Main Features

**50,000 Point FFTs** - Extremely long record FFTs provide significant signal-to-noise ratio improvement over two (or four) channels simultaneously.

**Wide-band frequency analysis** - Over DC to 350 MHz bandwidth range with high resolution.

**Sampling rates up to 10 GS/sec** - effectively eliminate aliasing errors.

**Frequency Resolution from 20  $\mu$ Hz to 100 MHz** - permits identifying narrow-spectral components within broad frequency ranges.

**Broad spectrum coverage** - FFTs are executed over record lengths as long as 50,000 data points giving up to 25,000 spectral components.

**Multi-channel Analysis** - All input channels can be analyzed simultaneously to allow comparison of independent signals for common frequency-domain characteristics.

**Versatile display formats** - Frequency-domain data may be presented as magnitude, phase, real, imaginary, log-power and log-PSD (power spectral density). These display formats can all be selected via menu options after signal capture.

**Standard window functions** - Rectangular for transient signals; von Hann (Hanning) and Hamming for continuous waveform data; Flattop for accurate amplitude measurements; Blackman-Harris for maximum frequency resolution.

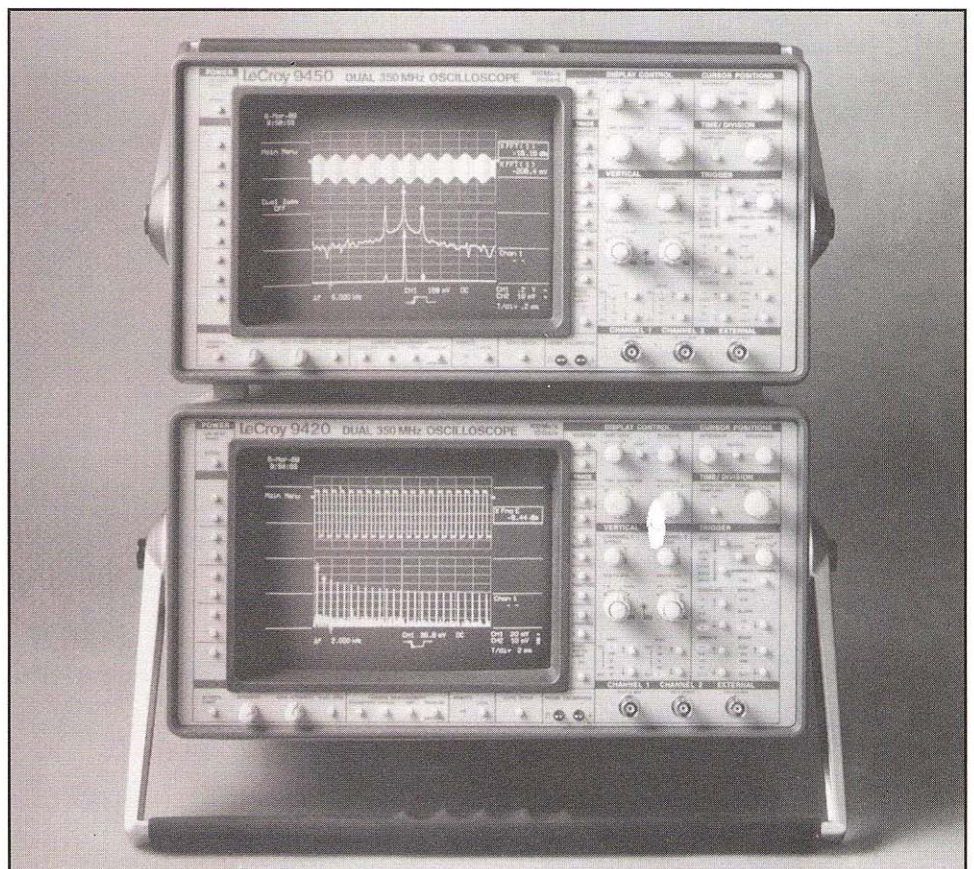

The instrument at the top (Model 9450) shows a modulated signal (top trace) analyzed in the frequency domain. Both power spectrum (middle) and magnitude (lower) are displayed. Side lobes 5 kHz from the fundamental frequency are clearly visible. The instrument at the bottom (Model 9420) shows a train of rectangular pulses (top trace) and the relative power spectrum (bottom).

**Calibrated vertical scaling** - Flattop truncation window provides precisely calibrated vertical scaling for all spectral components.

**Time-domain averaging** - Averaging real-time signals prior to FFT execution can increase the dynamic range up to 70 dB.

**Frequency domain averaging** - Up to 250 FFT results may be averaged to reduce base-line noise and enable analysis of phase-incoherent signals or signals which cannot be triggered on.



---

# Portable and Benchtop Digital Oscilloscopes

---

**Frequency cursors** - Cursors give up to 0.004% frequency resolution and measure power or voltage differences to 0.2% of full scale.

**Automatic DC suppression** - DC signal components may be suppressed automatically prior to FFT execution (menu selected).

**Full documentation** - The oscilloscope's status in the frequency domain is fully documented on one comprehensive display page which specifies parameters such as Nyquist frequency, number of points, vertical scaling and window function.

**Chaining of operations** - Two operations (four in the 9424) can be automatically chained, e.g., Function F = FFT of (CH1 X CH2). Any number of operations can be performed sequentially, either manually or via remote control.

**Full remote control** - All front-panel settings and waveform processing functions are programmable via GPIB or RS-232C interfaces. Acquired and processed waveforms can be downloaded to a computer and can later be retrieved and displayed on the oscilloscope.

**Color archiving** - Provides color hard copies of the screen using a wide range of digital plotters.

**Processing of expansions** - Up to two regions (four in the 9424) of the same waveform, or of different waveforms, can be expanded and processed simultaneously.

**FFT on segmented waveforms** - Individual waveform segments can be expanded and then analyzed using FFT. Time and date information is automatically recorded for each segment.

## Functional Description

### FOURIER PROCESSING

Fourier processing is a mathematical technique which enables a time-domain waveform to be described in terms of frequency-domain magnitude and phase, or real and imaginary spectra. It is used, for example, in spectral analysis, where a waveform is sampled and digitized, then transformed by a Discrete Fourier Transform (DFT). Fast Fourier Transforms (FFTs) are a set of algorithms used to reduce the computation time (by better than a factor of 100 for a 1000 point FFT) needed to evaluate a DFT. The principal advantage of FFT is the speed with which it can analyze large quantities of waveform samples. Using standard measurement techniques, FFT converts a time-domain measurement instrument into a digital spectrum analyzer.

The WP02 Spectrum Analysis package enhances the outstanding features of the LeCroy Models 9450, 9420 and 9424 Digital Oscilloscopes. It provides high resolution, wide-band spectrum analysis capabilities together with sophisticated window functions and fast processing.

### FFT AND LeCROY OSCILLOSCOPES

In FFT mode LeCroy oscilloscopes provide measurement capabilities superior to those of common swept spectrum analyzers. In particular, it is now possible to perform spectral analysis on repetitive and single events at an economic price. Users can obtain time and frequency values simultaneously and compare phases of the various frequency components with each other.

Rather than the commonly used "power of two" record lengths, the routines used in the WP02 package feature decimal record lengths, which can be selected in a 1, 2, 5 sequence. Resulting spectra are

also calibrated in convenient decimal Hertz values.

The WP02 package is supported by the exceptional acquisition characteristics which are the hallmark of LeCroy oscilloscopes ( $\pm 2\%$  DC accuracy, high effective bits, improved resolution through averaging). Computations are made using 16-bit processing that allows high accuracy, stability and repeatability. With LeCroy oscilloscopes, signals may be acquired and processed simultaneously using Channels 1 and 2 (1 to 4 in the 9424). This is particularly useful for network characterization or when looking for common frequency-domain characteristics on multiple signals.

### IMPROVED RESOLUTION

The Fast Fourier Transform calculates equally-spaced frequency components from DC to the full instrument bandwidth. By lowering the sampling rate, it is possible to make measurements with 20  $\mu$ Hz resolution up to 0.5 Hz (Nyquist). By increasing the sampling rate to 10 gigasamples/sec (100 psec/point) in random interleaved sampling mode, the widest resolution becomes 100 MHz and the Nyquist frequency 5.0 GHz, comfortably above the highest frequency components recordable by the oscilloscope, thus virtually eliminating aliasing effects.

### VERSATILE WINDOW FUNCTIONS

The WP02 FFT software provides a selection of window functions designed to minimize leakage and to maximize spectral resolution of single and non-cyclic events. These include the rectangular or unmodified window typically used for transient events, the Von Hann (Hanning) and Hamming windows for continuous signals, and also the Flattop and Blackman-Harris windows for more precise amplitude (power) measurements or strong suppression of side lobes respectively.



## 9450/20/24 WP02 Specifications

### MEMORIES

**Acquisition memory:** 50K, 8-bit word memories per channel.

**Reference and Function memories:** for the 9450/20 - 2 x 50K, 16-bit word reference memories which can each store one acquired or processed waveform (or up to 200 segmented waveforms) and 2 x 50K, 16-bit word function memories for waveform processing. The 9424 has 4 x 50K, 16-bit word memories which can be used both as reference or as function memories.

### FREQUENCY

**Frequency range:** DC to > 350 MHz.

**Frequency resolution:** 20  $\mu$ Hz to 100 MHz.

**Nyquist frequency range:** 0.5 Hz to 5 GHz. The Nyquist frequency can be adjusted and optimized after signal acquisition and prior to FFT execution.

**Frequency scale factors:** 0.05 Hz/div to 0.5 GHz/div in a 1-2-5 sequence.

**Frequency accuracy:** 0.01%

**Horizontal expansion:** up to 1000 times.

**Selection of the transform size:** 50 to 50000 data points in 10 steps in a 1-2-5 sequence. The transform size defines the decimation applied to the signal after the acquisition. The Nyquist frequency can be adjusted and optimized after signal acquisition and prior to FFT execution.

### AMPLITUDE AND PHASE

**Amplitude accuracy:** better than 2%.

Amplitude accuracy may be modified by the window function (see the window functions table below).

**Signal overflow:** a warning is provided at the top of the display when the input signal exceeds the ADC range.

**DC suppression:** selected via the menu (ON/OFF). It removes the DC component prior to FFT execution.

**Number of traces:** Time domain and frequency domain data can be displayed simultaneously (up to 4 waveforms).

**Phase range:** - 180° to + 180°.

**Phase accuracy:**  $\pm 5^\circ$  (for amplitude > 1.4 div).

**Phase scale factor:** 50° /division.

**Zero base line:** 0 div (center of screen).

### Spectrum Display Formats and Scaling

**Frequency scale:** linear, real, imaginary or complex spectrum, in V/div, zero base line at 0 div (center of screen).

Power spectrum in dBm (1 mW into 50  $\Omega$ ).

Power spectral density (PSD) in dBm.

**Phase display:** linear.

**Magnitude display:** linear.

Power and PSD spectra displays have 80 dB range (10 dB/div), expandable to 5, 2 or 1 dB/div.

### Frequency Domain Power Averaging

Up to 250 spectra for power, PSD or magnitude.

### Vertical Expansion

All spectral formats, up to 10 times, in a 1-2-5 sequence.

### Window Functions

Rectangular, von Hann (Hanning), Hamming, Flattop and Blackman-Harris. The table below indicates the filter pass band shape and the resolution:

### FILTER PASS BAND AND RESOLUTION

Window type	Filter bandwidth at -6 dB [freq. bins]	Highest side lobe [dB]	Scallop loss [dB]	Noise bandwidth [freq.bins]
Rectangular	1.21	-13	3.92	1.0
von Hann	2.00	-32	1.42	1.5
Hamming	1.81	-43	1.78	1.36
Flattop	1.78	-44	0.01	2.96
Blackman-Harris	1.81	-67	1.13	1.71

### Definitions

**Filter bandwidth at -6 dB** characterizes the frequency resolution of the filter.

**Highest side lobe** indicates the reduction in leakage of signal components into neighboring frequency bins.

**Scallop loss** is the maximum loss of amplitude accuracy of the magnitude spectrum.

**Noise bandwidth** is the bandwidth of an equivalent rectangular filter.

### FFT EXECUTION TIME

0.10 sec for a 1,000-point FFT.

1.14 sec for a 10,000-point FFT.

6.6 sec for a 50,000-point FFT.

### CURSORS

Absolute (cross-hair) and relative (arrows) cursors provide frequency and amplitude (phase, power, power density) measurements. Horizontal bars provide absolute and relative amplitude, and power and power density measurements.

### REMOTE CONTROL

All WP02 processing functions are fully programmable via the GPIB and RS-232C interfaces. Simple English-like commands are used.

**Remote read and write:** All waveform formats including complex can be read by computer for storage or further processing. Externally generated waveforms can be written into the Memories C and D for FFT or other processing.

### STORED FRONT PANELS

Up to 7 front-panel setups, including WP02 menu settings can be stored in non-volatile memory and recalled by the menu buttons at the left side of the screen.

### WP02 INSTALLATION

A WP02 package may be retrofitted to a LeCroy 9450/20/24 Digital Oscilloscope.



# Portable and Benchtop Digital Oscilloscopes

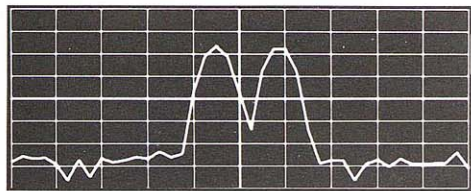

Blackman-Harris

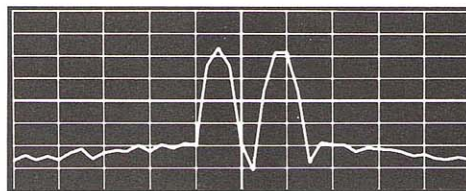

Hamming

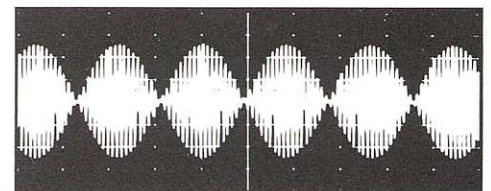

The sum of two sinusoids of 500 kHz and 527.5 kHz is digitized over 200 points and transformed to the frequency domain. Four different window functions (see left) are applied to indicate their effect on leakage suppression and spectral resolution.

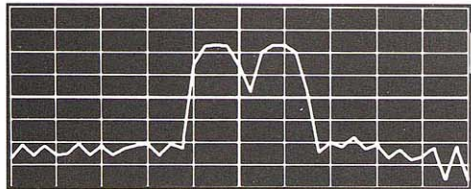

Flattop

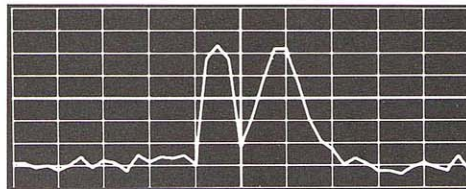

von Hann (Hanning)

ORDERING INFORMATION	
Code	Description
9450WP02	FFT Firmware for 9450
9420WP02	FFT Firmware for 9420
9424WP02	FFT Firmware for 9424

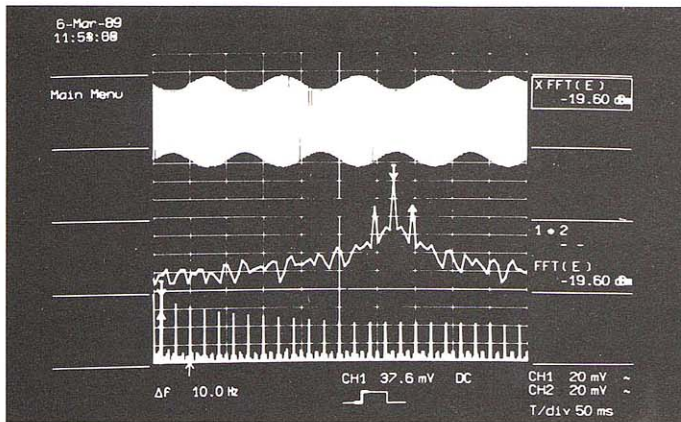

Long records give wide frequency span. FFT of a 1000 Hz amplitude modulated square wave, recorded over 50,000 points, shows harmonics up to 51 kHz. Expansion shows side bands at 10 Hz and -19.6 dBm.

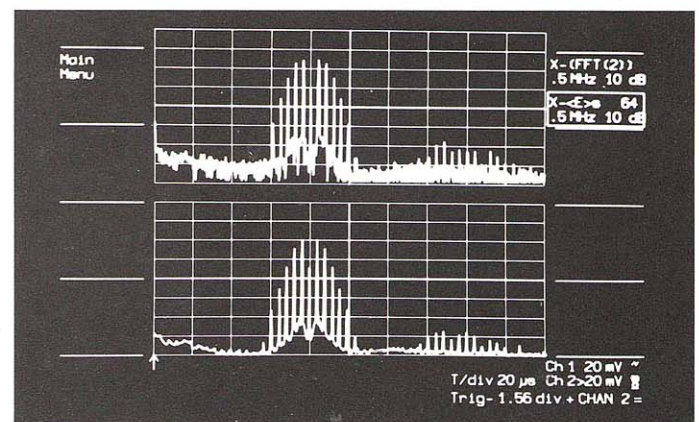

A 2 MHz signal is frequency modulated with a 99 kHz sine wave. To improve the signal-to-noise ratio on the phase-incoherent FM Signal, 64 spectra are averaged (bottom trace). The part of the spectrum at the right-hand side is the 2nd harmonic of the carrier with side bands.

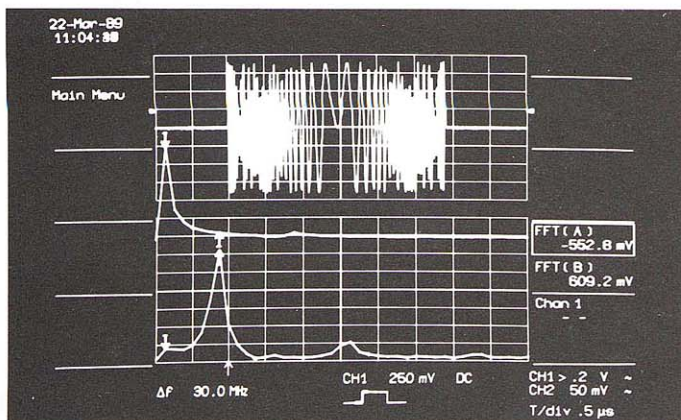

A frequency coded radar signal has been captured in single shot (upper trace). Two time windows have been applied (not visible on the screen) to isolate different portions of the signal and the respective FFTs have been calculated. The middle and the lower trace show the two amplitude spectra. A frequency shift of 30 MHz is clearly visible.

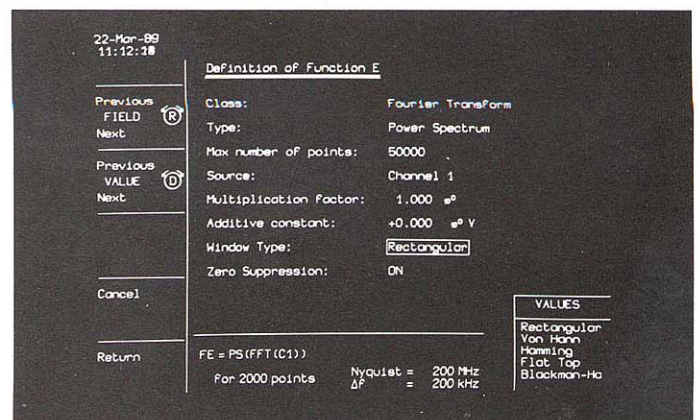

The FFT menu documents all the relevant parameters.



## 9400A Portable Dual-Channel Digital Oscilloscope

### Main Features

**175 MHz Bandwidth** - Each of two independent channels has 175 MHz bandwidth and its own high-performance 8-bit ADC.

**High Vertical Precision** - Each independent channel converts input signals with better than  $\pm 2\%$  DC accuracy ( $\pm 1\%$  optional).

**1024 x 1024 Display** - The 9400A's large display screen produces bright, stable, razor-sharp pictures of your signal under any repetition rate conditions. Very accurate signal comparisons are possible as up to four waveforms (live, expanded or processed) can be displayed simultaneously.

**Precise Time-Base Resolution** - Long memories and a versatile cursor system (including voltage, time and cross-hair cursors), give time measurements with an accuracy of  $\pm 0.02\%$  of the time-base setting, and resolution of  $\pm 0.002\%$  full scale.

**Long 32K Memories** - The long 32K acquisition memories of the 9400A capture waveforms with high fidelity. At similar time-base settings, the 9400A's long memories allow sampling rates up to 25 times faster than that of instruments which have only 1K of acquisition memory (see graph next page). Faster sampling rates ensure higher single shot bandwidth as well as significantly reducing problems caused by under-

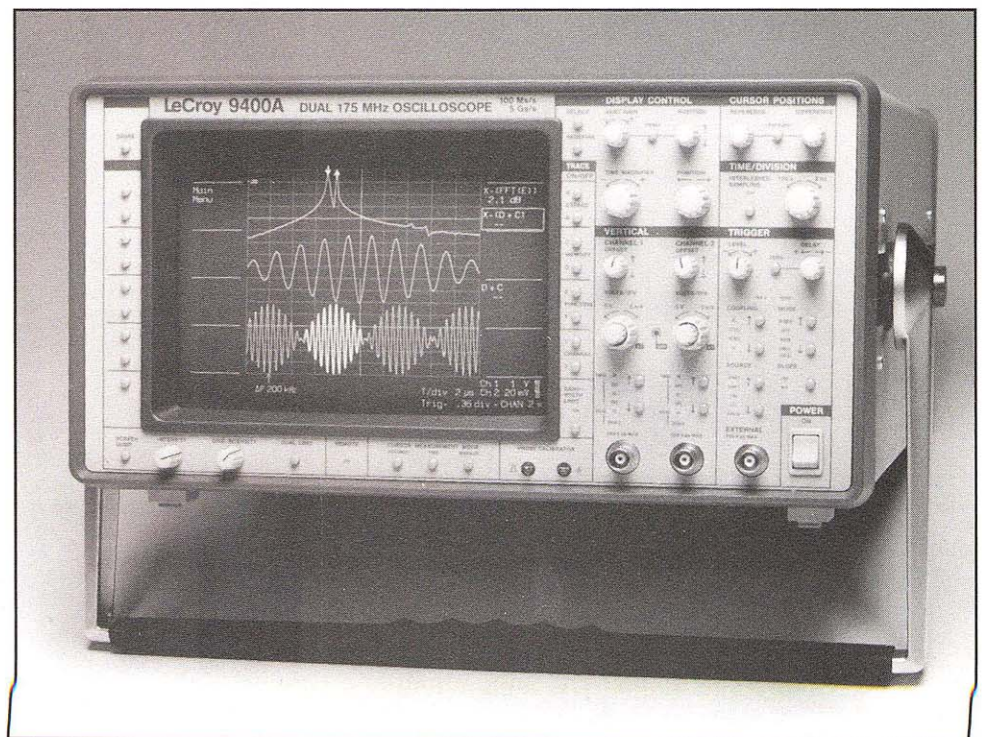

sampling and aliasing. The 9400A's long memories allow displayed waveforms to be expanded up to 100 times to show the finest signal details.

**5 GS/sec Sampling** - The 9400A features sampling rates of up to 5 gigasamples/sec for repetitive signals.

**100 MS/sec Transient Recording** - With a sampling rate of 100 megasamples/sec, the 9400A is an extremely powerful transient recorder.

Long 32K data point acquisition memories, combined with a continuously adjustable trigger (from 100% pre-trigger to 10000 divisions post-trigger at any time-base setting), ensure that rare events cannot be missed. Both channels are sampled simultaneously so that exact time correlation is maintained between channels.



# Portable and Benchtop Digital Oscilloscopes

**Full Programmability** - All the 9400A's front-panel controls are fully programmable via the two RS-232C interface ports or the GPIB port. A single pushbutton initiates a Screen Dump for accurate color hard copies of the display via a wide range of digital plotters. The GPIB port comes complete with LeCroy "MASP" software, offering computer control and mass storage on any PC compatible with the IBM® standard.

**Signal Processing** - The waveform processing options extend the applications of the 9400A to high bandwidth signal characterization, as well as mathematical and spectral analysis. The routines include averaging (summed and continuous), smoothing, integration, differentiation, square, square-root, full arithmetic, FFT spectral analysis, and Extrema monitoring.

**Mass Storage and Remote Control** - A sophisticated mass storage and remote control package is available to assist users involved in automated and computer-aided testing. Convenient portability for field applications is also provided by a laptop computer.

SINGLE-SHOT BANDWIDTH (NYQUIST FREQUENCY) VS. TIME BASE SETTING

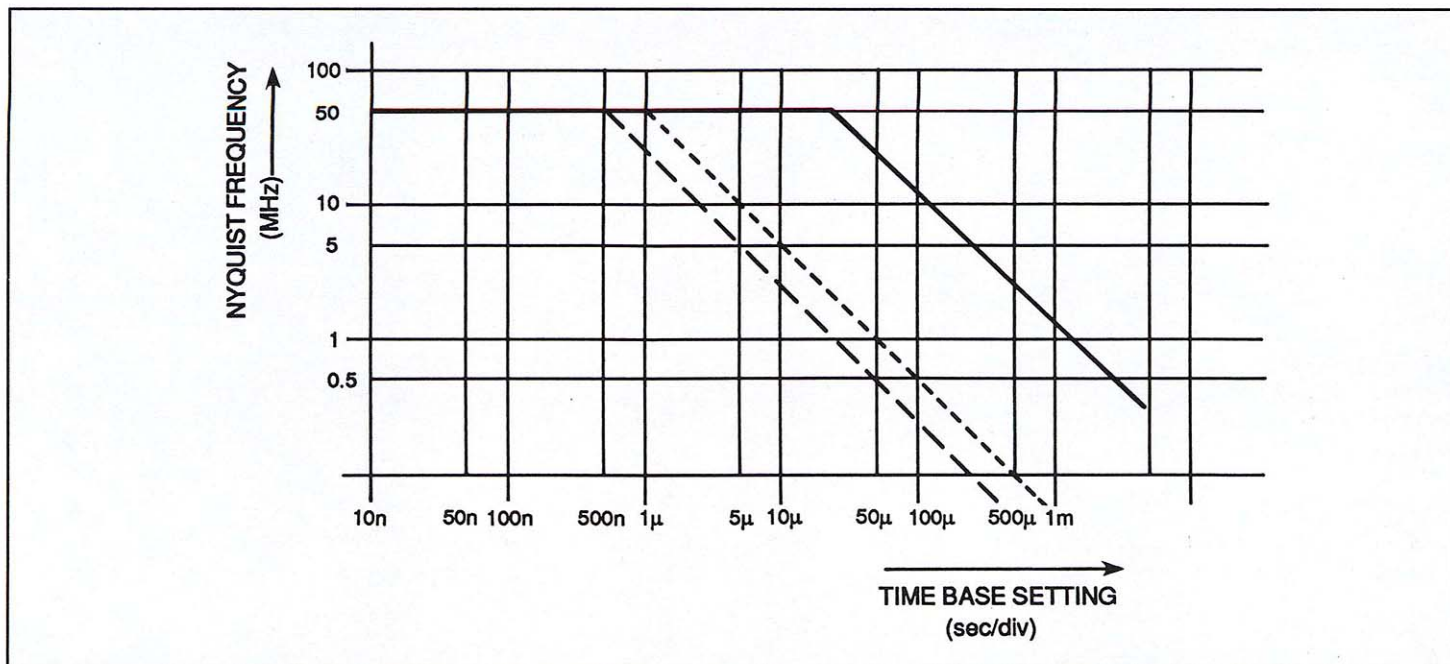

Single-shot bandwidth is a function of sampling rate. Long memories enable higher sampling rates at equal time-base settings. Above, the 9400A (solid line) is compared to oscilloscopes with 1K (dotted line) and 512 points (dashed line) of memory. At slower time-base settings, the single-shot bandwidth of the 9400A, expressed as Nyquist frequency, is typically 25 times higher than in oscilloscopes with 1K memory and 50 times higher than in those with only 512 points.



## 9400A Specifications

### VERTICAL ANALOG SECTION

#### Bandwidth (-3 dB):

@50Ω: DC - 175 MHz at 10 mV/div,  
up to 225 MHz at 1 V/div;  
DC - 150 MHz at 5 mV/div.

@1 MΩ AC: <10 Hz - 100 MHz typical,

@1 MΩ DC: DC - 100 MHz typical.

**Single shot:** DC - 50 MHz (Nyquist).

**Input impedance:** 1 MΩ //50 pF and 50Ω ±1%

**Channels:** Two; standard BNC connector inputs.

**Sensitivity:** 5 mV/div to 1 V/div at 50Ω and 5mV/div to 5 V/div at 1MΩ impedance; detents at 1-2-5,1: 2.5 continuously variable.

**Offset:** ±8 divisions in 0.04 division increments.

**DC accuracy:** Standard ≤ ±2%, optional ≤ ±1%.

**Noise:** ≤0.45% RMS.

**Bandwidth limiter (-3 dB):** 30 MHz.

**Max input voltage:** 250V (DC + peak AC) at 1MΩ, 5 V DC (500 mW) or ±10 V peak AC at 50Ω.

### VERTICAL DIGITAL SECTION

**ADC:** One per channel, 8-bit flash.

**Conversion rate:** Up to 100 megasamples/sec for transient signals, up to 5 gigasamples/sec for repetitive signals, simultaneously on both channels.

**Aperture uncertainty:** ±10 psec.

**Overall dynamic accuracy (typical):** Sine wave applied to the BNC input for RMS curve fit at 80% full scale. The accuracy measurement includes front-end amplifier, sample & hold and ADC.

Input frequency (MHZ)	1	10	Nyquist 50	100	175
Signal-to-noise ratio (dB)	41.9	41.9	41.9	37.1	29.9
Effective Bits	7.0	7.0	7.0	6.2	5.0

#### Acquisition memories Channel 1 and 2:

Two, 32K 8-bit word memories (64K total) which can be segmented into 8, 15, 31, 62,125 or 250 blocks.

**Reference memories C and D:** Two 32K 16-bit word memories (64K total) which can store two acquired and/or processed waveforms.

**Function memories E and F (optional) Two,** 32K 16-bit word memories (64K total) for waveform processing.

**Glitch detection:** Permanent glitch detection for events down to 0.04% of the time-base setting,10 nsec minimum.

### HORIZONTAL SECTION

#### Time base

**Range:** 2 nsec/div - 100 sec/div

**Accuracy:** Better than ±0.002% of the time-base setting.

**Interpolator resolution:** 10 psec.

#### Acquisition modes:

**Random Interleaved Sampling (RIS)** for repetitive signals from 2 nsec/div to 2 μsec/div;

**Single shot** for transient signals and repetitive signals from 50 nsec/div to 200 msec/div;

**Roll** for slowly changing signals from 500 msec/div to 100 sec/div;

**Sequence** for capturing transients in segmented memories of 8,15, 31, 62, 125 or 250 blocks.

#### Trigger

**Sources:** CH1, CH2, LINE, EXT, EXT/10.

**Slope:** Positive, negative, window.

**Coupling:** AC, LF REJ, HF REJ, DC

#### Modes:

**Sequence,** stores multiple events in segmented acquisition memories.

**Auto,** automatically re-arms after each sweep. If no trigger occurs, one is generated at 2 Hz repetition rate.

**Normal,** re-arms after each sweep. If no trigger occurs after 2 sec, the display is erased.

**Single (hold),** holds display after a trigger occurs. Re-arms only after the single-button is pressed again.

**Pre-trigger:** Adjustable in 0.2% increments, to 100%.

**Post-trigger delay:** Adjustable in 0.02 division increments up to 10000 divisions.

**External trigger input:** 1 MΩ, <30 pF, 250 V max., ±2 V in EXT,± 20 V in EXT/10.

**Rate:** >200 MHz.

### SELF TESTS

**Auto-calibration:** Performed every 20 minutes or whenever the gain or time-base parameters are changed; provides accuracies of:

DC gain: ±2% (±1% optional) of full scale;

Offset: ±0.5% of full scale (50 Ω only);

Time: 20 psec RMS.

During the warming-up period, auto-calibration is carried out at 1 minute intervals unless the oscilloscope is in single or sequence trigger mode.

### DISPLAY

**CRT:** 12.5 x 17.5 cm (5 x 7 inches); magnetic deflection; vector graphics system.

**Resolution:** 1024 x 1024 addressable points.

**Grid:** Internally generated; separate intensity control for grid and waveforms. Single and dual grid mode.

**Expansion:** Dual zoom horizontal expansion operates simultaneously on live, stored and processed waveforms, expanding up to 100 times. Vertical expansion from 0.4 up to 2 times for non-processed waveforms, up to 10 times for processed waveforms.

**Screen dump:** Single or multi-pen digital plotters are menu selected. The 9400A supports the HP7400 series, as well as the Tektronix 4662, Philips PM 8151, Graphtek WX 4638/6, and compatible models. Screen dumps are activated by a front-panel push-button.



# Portable and Benchtop Digital Oscilloscopes

**Cursors:** Two time cursors give time resolution of  $\pm 0.2\%$  of full scale for unexpanded traces; up to  $\pm 0.002\%$  for expanded traces. The corresponding frequency information is also provided. Two voltage cursors measure voltage differences to 0.2% of full scale for each trace.

A **cross-hair** marker measures absolute voltage versus signal ground as well as the time relative to the trigger. Time and cross-hair cursors indicate Hz and dB or volt values when an FFT spectrum analysis is made.

**Menus:**

**Standard** Waveform storage; Acquisition parameters; Memory status; Store/recall front-panel configurations; RS-232-C configuration; Plotter setup.

**Optional:** (WP01/WP02) Averaging, arithmetic, functions, extrema, smoothing, FFT and frequency domain averaging.

## REMOTE CONTROL

All the front-panel controls, including variable gain, offset and position controls (not cursor positioning), and all the internal functions are programmable.

**RS-232C ports:** Two: for computer/terminal control and plotter connection. Asynchronous up to 19200 baud.

**GPIB port:** (IEEE-488). Configured as talker/listener for computer control and fast data transfer; 400 kilobytes/sec maximum, ASCII or binary. The address switches are on the rear panel. This also includes LeCroy MS02 (MASP) IBM PC-based software for mass storage and remote control applications. For further details on MASP software, please refer to the MS01/02 data sheet.

## PROBES

**Probe calibration:** 976 Hz square wave, 1 V p-p  $\pm 1\%$ .

**Standard probes:** Two Model P9010, x10 attenuating passive probes with 10 M $\Omega$  input impedance in parallel with a 5.5 pF capacitance.

**Probe power:** Two power outlets on the rear panel provide  $\pm 15$  V and  $\pm 5$  VDC for active probes.

## GENERAL

**Temperature:** 5 to 40°C rated; to 50°C operating.

**Humidity:** 80%.

**EMI immunity:** The 9400A complies with the following standards: IEC 801, VDE 0871, FCC PART 15 and SEV.

**Safety standards:** The 9400A complies with the following: IEC-348, ASE 3453 and VDE 0411.

**Power required:** 110 or 220 VAC, 48 to 65 Hz, 200 W.

**Battery back-up:** NiCd batteries maintain front-panel settings for 6 months minimum.

**Dimensions:** (HWD) 19.2 x 36.5 x 46.5 cm, (7 1/2 x 14 3/8 x 18 3/8 inch).

**Weight:** 14 kg (30 lbs) net, 20 kg (44 lbs) shipping.

**Warranty:** 2 years

## ORDERING INFORMATION

### Oscilloscope and Options

Code	Description
9400A	Digital Oscilloscope
9400AOP01	High-precision option ( $\pm 1\%$ DC accuracy)
9400AWP01	Waveform processing option
9400AWP02	Fast Fourier processing option (requires 9400AWP01)
9400AMS01	Mass storage and remote control package, including an IBM lap-top controller, interface, cables and software
9400AIM01	GPIB interface for IBM-PCC computers
9400CS01	Calibration Software

## CERTIFIED CALIBRATION CS9400

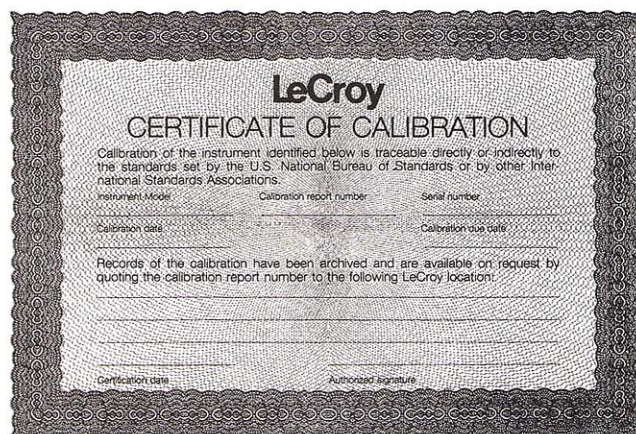

*Certified traceable calibration to NBS or any other national standard is obtained by specifying CS9400 when ordering the 9400A*



## WP01 Waveform Processing Firmware for 9400A Digital Oscilloscopes

### Main Features

#### Averaging: Summation and Continuous

- Summation averaging up to 1,000,000 waveforms.
- Continuous averaging with weighting factors up to 128. Averages up to 100,000 words/sec in summation mode.
- Increases dynamic range to  $\mu$ Volt sensitivity.

**Offset Dithering** - Improves the vertical resolution for low-noise measurements by several bits in summation averaging mode. Reduces the effect of ADC differential nonlinearities.

**Artifact Rejection** - Rejects waveforms that exceed the dynamic range of the ADC to ensure statistical validity of summed average results.

**"Extrema" Mode** - Keeps track of time and amplitude drift by storing extreme positive and negative values, such as glitches, over a programmable number of sweeps.

**Powerful Arithmetic** - Processes addition, subtraction, multiplication, or division on pairs of waveforms stored in the 9400A's memory locations CH1, CH2, C, D, and E. Waveform data can be normalized by additive or multiplicative constants.

**Complex Functions** - Computes integration, differentiation, square, square root and negation on single waveforms stored in the 9400A memory locations CH1, CH2, C, D, and E. Waveform data can be multiplied by constants.

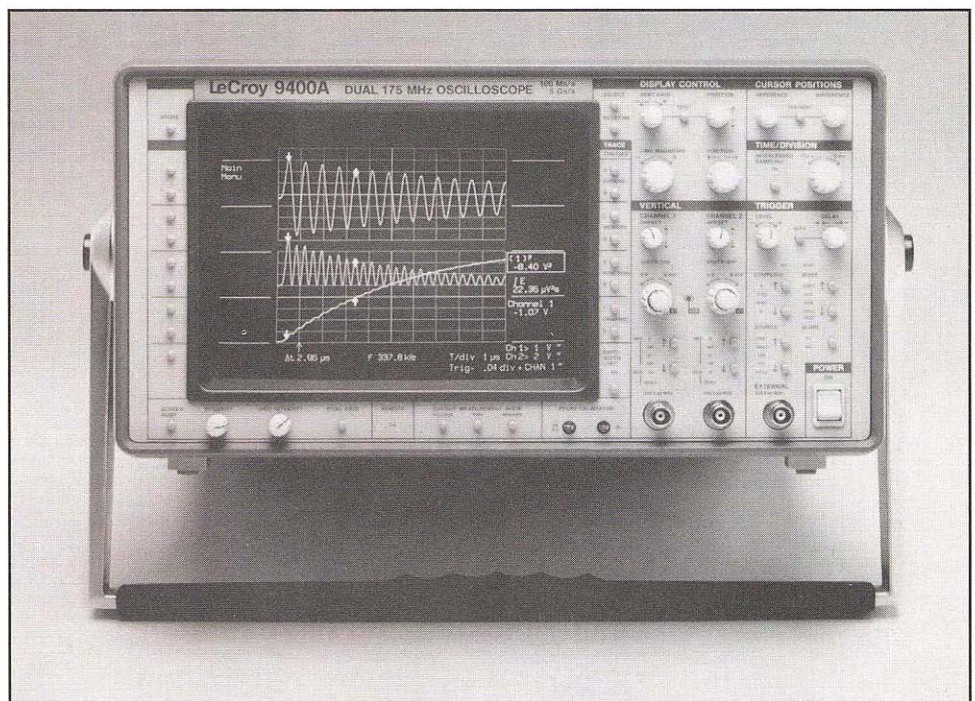

By chaining different mathematical functions together, the WP01 waveform processing package can perform complex measurement sequences with ease. Above, a damped sine wave (top) is squared (middle) and then integrated (bottom) allowing RMS measurements to be calculated.

**Smoothing** - Allows two smoothing modes to reduce unwanted noise on single events:

- Mean value smoothing down to 50 segments;
- N-point smoothing with up to 9-point filter.

**Vertical Expansion** - Provides vertical scale expansion by a factor of up to 10 in signal averaging mode.

**Chaining of Operations** - Automatically chains two operations. Example:  $F(E) = \text{Average (CH1-CH2)}$ . An indefinite

number of operations can be performed sequentially, either manually or via remote control.

**Remote Control** - Controls remotely all front-panel settings, as well as all waveform processing options via either GPIB or RS-232C interfaces.

**Color Archiving** - Copies screen in color using a wide range of digital plotters.



## Functional Description

WP01, an optional waveform processing firmware package for the 9400A Digital Oscilloscope, is optimized for processing signals in real time. The powerful 68000-based system permits rapid representation of processed results such as averages, differentiations, multiplications, integrations and smoothing of waveforms.

Waveform operations can be performed on live or stored signals, or a combination of both. They are selected through simple menus, and it is even possible to chain them and compute, for example, the integral of the multiplication of two traces, or average the difference of CH1 and CH2.

WP01 includes an additional 512 KB random access memory for accumulation, computation and waveform buffering. It permits the accumulation of up to 1,000,000 waveforms of 32,000 points each.

All processing occurs in waveform memories E and F which may be displayed on the screen by pressing FUNCTION E, F buttons. Whenever one of the FUNCTIONS E or F or their expansions (EXPAND A or B) is turned on, the corresponding waveform processing is executed and the result displayed.

### SIGNAL AVERAGING

**Summed averaging** - consists of the repeated addition, with equal weight, of recurrences of the selected source waveform. Whenever the required number of waveforms is reached, the averaging process will stop. The total number of waveforms to be accumulated can be selected between 10 and

1,000,000 sweeps in a 1-2-5 sequence. Signals exceeding the dynamic range of the 9400A's 8-bit ADC at any point may be automatically rejected to ensure valid summed averaging results.

**Continuous averaging** - sometimes called exponential averaging, consists of the repeated weighted average of the source waveform with the previous average. This mode of averaging is a continuous process. The effect of previous waveforms gradually tends to zero. Relative weighting factors can be chosen from 1:1 to 1:127. This averaging mode is most useful for setting up measurements or observing noisy signals that change with time.

### EXTREMA MODE

Tracking rare glitches or monitoring signals drifting in time and amplitude is made easy with the unique EXTREMA mode. The computation of extrema consists of a repeated comparison of recurrences of the source waveform with the accumulated extrema waveform.

Whenever a given data point of a new acquisition exceeds the existing data point of the stored waveform, the old data point is replaced by the new. In this way the maximum and/or minimum envelope of all waveforms is accumulated up to a maximum of 1,000,000 sweeps.

### ARITHMETIC

WP01 also offers basic arithmetic operations such as addition, subtraction, division, and multiplication. These arithmetic functions can be performed on two source waveforms on a point-by-point basis. Different vertical gains and offsets of the two sources are automatically taken into account. However, both source waveforms must have the same

time base setting. The first waveform may be multiplied by a constant factor and offset by a constant.

### MATHEMATICAL FUNCTIONS

Mathematical functions such as negation, square, square root, integral and differentiation are performed on a single source waveform. The waveform may be multiplied by a constant factor and may be offset by a constant. Arithmetical and mathematical functions may be chained with memory C and D.

### SMOOTHING

**Mean value smoothing** divides the acquired signal into a chosen number of segments and then generates the smoothed waveform in which each displayed point corresponds to the mean value of "n" points contained in the corresponding segment. The number of segments can be between 50 and 32,000. Mean value smoothing takes all digitized points on the screen into account.

**N-point smoothing** applies a moving-average of N points symmetrically placed around each of the 50 to 32,000 selected points for display.

Each selected point  $Y_k$  is replaced in the smoothed waveform by a processed point  $Y'_k$  corresponding to:

$$Y'(k) = \sum_{n=-(N-1)/2}^{(N-1)/2} C(n) Y(k+n)$$

where, in case of a 3-point filter,  
 $N = 3$ ;  $C_{-1} = 1/4$ ;  $C_0 = 1/2$ ;  $C_1 = 1/4$

The number of points N can be selected to be 3, 5, 7, or 9.



## 9400AWP01 Specifications

### SUMMATION AVERAGING

**Number of sweeps:** 10 to 1,000,000 can be selected in a 1-2-5 sequence.

**Number of points averaged over CH1, CH2:** 50 to 32,000 in 10 steps.

**Offset dithering:** Up to 6 LSBs may be chosen.

**Artifact rejection:** ON/OFF

**Theoretical signal-to-noise improvement achievable:** 57 dB

**Vertical expansion:** 10 times maximum.

**Maximum sensitivity:** 500  $\mu$ V/div after vertical expansion.

### CONTINUOUS AVERAGING

**Number of sweeps:** Infinite

**Weighting factors selectable:** 1:1, 1:3, 1:7, 1:15, 1:31, 1:127.

**Number of points averaged:** 50 to 32,000 in 10 steps

**Vertical expansion:** 10 times maximum

**Maximum sensitivity:** 500  $\mu$ V/div after vertical expansion.

### AVERAGING SPEED

The figures below assume that the display time between triggers is negligible:

record length (# of points)	summation (sweeps/sec)
32000	3
25000	4
12500	6
6250	13
2500	32
1250	51
625	73
250	100
125	112
50	118

In interleaved sampling mode, the averaging speed is reduced as more signals are required to complete a displayed waveform.

### WAVEFORM ARITHMETIC

Addition, subtraction, multiplication, and ratio can be performed on two live waveforms from CH1 and CH2, or from stored waveforms in memories C, D and E.

Example: E = CH1 - CH2  
F = CH2\*D  
G = CH1 + E

**Number of points processed:** from 50 to 32,000 can be selected in 10 steps.

**Multiplicative constants:** from 0.01 to 9.99 can be selected in steps of 0.01.

**Additive constant:** from -9.99 to 9.99 divisions can be selected in steps of 0.01.

**Vertical expansion:** 2 times maximum.

**Typical execution time for 1250 points:** 600 msec.

### WAVEFORM FUNCTIONS

Integration, differentiation, square, square root, negation (invert).

Examples: E =  $\int$  CH1 dt  
F = -CH2  
G = dD/dt

**Number of points processed:** from 50 to 32,000 can be selected in 10 steps.

**Multiplicative constants:** from 0.01 to 9.99 can be selected in steps of 0.01

**Additive constant:** from -9.99 divisions to 9.99 divisions can be selected in steps of 0.01.

**Vertical expansion:** 2 times maximum.

**Typical execution time for 1250 points:** 400-1000 msec.

### MEAN VALUE SMOOTHING

**Number of adjacent blocks processed:** 50 to 32,000 in 10 steps.

**Number of points per block:** varies with the time base and the number of blocks selected.

**Typical execution time for 1250 points:** 700 msec.

### N-POINT SMOOTHING

Filter coefficients with weighting factors for successive data points:

3 point - (1:2:1) 1/4

5 point - (1:4:6:4:1) 1/16

7 point - (1:6:15:20:15:6:1) 1/64

9 point - (1:8:28:56:70:56:28:8:1) 1/256.

**Number of points processed:** 50 to 32,000 in 10 steps

**Vertical expansion:** 2 times maximum.

**Typical execution time of 1250 points:** 500 msec.

### EXTREMA MODE

Logs all extreme values of a waveform over a programmable number of sweeps. Maxima and minima are displayed separately by ROOF and FLOOR traces.

**Number of sweeps:** selected in a 1-2-5 sequence from 1 up to 1,000,000.

**Number of points processed:** 50 to 32,000 in 10 steps. Glitches as short as 10 nsec or 0.04% of the time base setting are displayed. Vertical expansion: 2 times maximum.

**Typical execution time for 1250 points:** 300 msec.

### CHAINING OF OPERATIONS

Two functions can be automatically chained using functions E and F.

Example: E = CH1 - CH2  
F = summed average of E

Manual chaining using memory C and D for intermediate results may continue indefinitely.

### REMOTE CONTROL

All front-panel controls and Waveform Processing functions are fully programmable via either the 9400A's GPIB or RS-232-C interfaces. Simple English-like mnemonics are used.

### STORED FRONT PANELS

Up to 7 front panel setups, including WP01 menus, can be stored and recalled by the menu buttons at the left side of the 9400A screen.

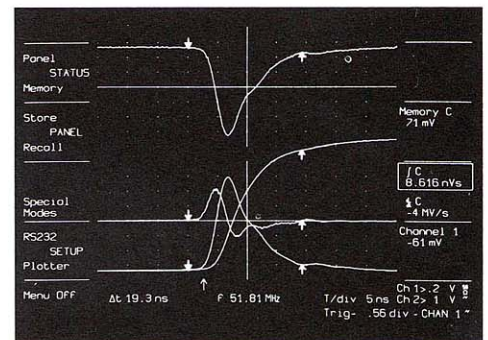

A fast negative going signal at 5 nsec/div (upper trace) recorded in Random Interleaved Sampling mode is inverted and stored in memory C (lower trace). Integral and differential are shown in function E and function F. The area under the inverted curve is measured by first defining the area with the time cursors and then reading the value of C. In this case: 8.616 nVs.



## WP02 Spectrum Analysis Firmware for 9400A Digital Oscilloscope

### Main Features

**50 to 25,000 Point FFTs** - Long record FFTs provide significant signal-to noise ratio improvement on single phenomena and yield up to 12,500 spectral components at almost any sampling rate.

**DC to 175 MHz Frequency Domain Analysis** - Covers a wide bandwidth with 1 mHz to 50 MHz resolution.

**Simultaneous Dual Channel Analysis** - Both input channels can be analyzed simultaneously to allow comparison of independent signals for common frequency characteristics.

**Fast FFT Processing** - A 1250 point waveform is transformed in < 1.8 sec; a 50 point waveform within .3 sec.

**Versatile Display Formats** - Frequency domain data may be presented as magnitude, phase, real,imaginary, log-power, log-PSD (power spectral density) via menu options after signal capture.

**Standard Window Functions** - Rectangular for transient signals; von Hann (Hanning) and Hamming for continuous waveform data; Flattop for accurate amplitude measurements; Blackman-Harris for best frequency resolution.

**User-definable Window Functions** - Specially defined window functions can be loaded over GPIB and stored in the 9400A's reference memories.

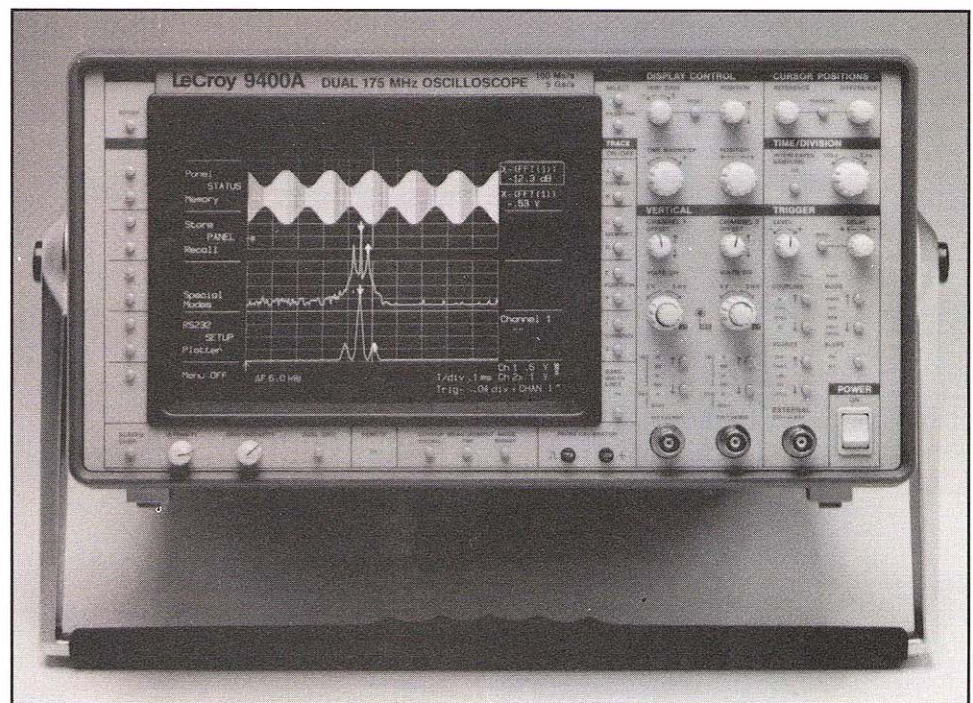

*A modulated signal (top trace) is analyzed in the frequency domain using the 9400A's FFT processing capability which provides power (middle) and magnitude (lower) information. Side lobes 6 kHz from the fundamental frequency are clearly visible.*

**Calibrated Vertical Scaling** - Flattop truncation window provides precisely calibrated vertical scaling for all spectral components.

**Frequency Domain Averaging** - Averages up to 200 FFT results to reduce base-line noise and allows analysis of phase-incoherent and non-triggerable noisy signals.

**Time Domain Averaging** - Can increase the dynamic range up to 72 dB or more when averaging real-time

signals prior to FFT execution. Offset dithering helps to improve dynamic range and reduces ADC non-linearity effects.

**Frequency Cursors** - Cursors give up to 0.008% frequency resolution and measure power or voltage differences to 0.2% of full scale.

**Automatic DC Suppression** - DC signal components may be suppressed automatically prior to FFT execution (menu selected).



**Full Documentation Displayed** - The 9400A DSO status in the frequency domain is fully documented on one comprehensive display page specifying Nyquist frequency, number of points, vertical scaling, window function, etc.

**Chaining of Operations** - Chains two operations automatically, e.g., Function F = FFT of (CH1 X CH2). Any number of operations may be performed sequentially, either manually or via remote control.

**Full Remote Control** - All front panel settings and waveform processing functions are programmable via GPIB and/or RS-232C interfaces. Acquired and processed waveforms can be downloaded to a computer and can later be retrieved and displayed on the 9400A.

**Color Archiving** - Provides color hard copies of the screen, using a wide range of digital plotters.

## Functional Description

### FOURIER PROCESSING

Fourier processing is a mathematical technique which permits a time-domain waveform to be described in terms of frequency domain magnitude and phase, or real and imaginary spectra. In spectral analysis, a waveform can be sampled and digitized, then transformed by a discrete Fourier transform (DFT). Fast Fourier Transforms are a set of algorithms used to reduce the computation time (by better than a factor of 100 for a 1000 point FFT) needed to evaluate a DFT. The principal advantage of the FFT is the rapidity with which it can analyze large quantities of waveform

samples. In effect, using standard measurement techniques, it converts a time-domain instrument into digital spectrum analyzer.

The WP02 Fast Fourier Processing package enhances the outstanding features of the LeCroy 9400A Digital Oscilloscope. It provides high resolution, wide-band spectrum analysis capabilities along with sophisticated window functions and fast processing.

### FFT AND THE LeCROY 9400A DIGITAL OSCILLOSCOPE

In FFT mode, the 9400A provides measurement capabilities superior to those of common swept spectrum analyzers. In particular, it is now possible to perform spectral analysis on continuous and single events at an economic price. And it enables users to obtain time and frequency values simultaneously and to compare phases of the various frequency components with each other. Rather than the commonly used "power of two" record lengths, the routines used in the WP02 package feature decimal record lengths, which can be selected in a 1-2-5 order. Resulting spectra are therefore also calibrated in convenient decimal Hertz values.

The FFT's digital nature ensures high accuracy, stability and repeatability. These are strongly supported by the 9400A's superb DC and dynamic accuracy specifications, such as the standard  $\pm 2\%$ , optional  $\pm 1\%$ , DC accuracy, high effective-bit count and increased resolution through signal averaging and dithering. With the 9400A, signals may be acquired and processed simultaneously using Channels 1 and 2. This is particularly useful when looking

for common frequency-domain characteristics in both signals or for characterization of networks.

### IMPROVED RESOLUTION

The Fast Fourier Transform calculates equally-spaced frequency components from DC to the full 9400A bandwidth. By lowering the sampling rate, it is possible to make measurements with 1 milli-Hertz resolution up to 12.5 Hertz (Nyquist). By increasing the sampling rate to 5 giga-samples/sec (200 psec/point) in Random Interleaved Sampling mode, the widest resolution becomes 50 MHz and the Nyquist frequency 2.5 GHz... comfortably above the highest frequency components recordable by the 9400A, thus virtually eliminating aliasing effects.

### VERSATILE WINDOW FUNCTIONS

The WP02-FFT software provides a selection of window functions, designed to minimize leakage and to maximize spectral resolution of single and non-cyclic events. These include the familiar rectangular or unmodified window typically used for transient events, the von Hann (Hanning) and Hamming windows for continuous signals, and in addition, Flattop and Blackman-Harris windows for more precise amplitude (power) measurements or strong suppression of side lobes respectively.

Furthermore, user-defined window functions may be loaded onto the 9400A via the GPIB interface. Through multiplication, they modify the acquired signal followed by FFT in an automated fashion.



## 9400AWP02 Specifications

### FREQUENCY

**Frequency range:** DC to >175 MHz.

**Frequency resolution:** 1 mHz to 50 MHz.

**Nyquist frequency range:** 25 mHz to 2.5 GHz.

**Frequency scale factors:** 5 mHz/div to 500 MHz/div in 1-2-5 sequence

**Frequency accuracy:** 0.008% at center lobe.

**Horizontal expansion:** Up to 100 times.

**Cursors:** Differential (arrows) and absolute (crosshair) provide frequency and related amplitude measurements.

### AMPLITUDE AND PHASE

#### General

**Amplitude accuracy:** See window functions table below.

**Signal overflow:** A warning indication is provided at the top of the 9400A display when the input signal exceeds the ADC range.

**DC suppression:** Selected via the menu (ON/OFF), removes DC component prior to FFT execution.

**Cursors:** Horizontal bars provide differential amplitude measurements.

**Number of traces:** Time domain and frequency domain data can be displayed simultaneously (up to 4 traces).

#### Spectrum Display Formats and Scaling:

**Real spectrum,** in V/div, zero base line at 0 div (center of screen)

**Imaginary spectrum** in V/div, zero base line at 0 div.

**Power spectrum** in dBm.

**Power spectral density** in dBm.

**Frequency domain averaging** up to 200 spectra for power, PSD or magnitude.

**Log display** applies to power and PSD spectra in 10, 5, 2 or 1 dB/div, 80 dB display range. Markers at left edge of screen give absolute dBm reference (0 dBm is 1 mW into 50  $\Omega$ ).

#### Phase

**Phase range:** +180 degrees to -180 degrees.

**Phase accuracy:**  $\pm 5$  degrees.

**Phase scale factor:** 50 degrees/div.

**Zero base line:** 0 div (center of screen).

#### Calibrated Vertical Expansion

All spectra formats, up to 10 times, in 1-2-5 sequence.

#### Window Functions

**Selected in menu:** Rectangular, von Hann (Hanning), Hamming, Flattop, Blackman-Harris and user definable. The table below gives filter pass band shape and resolution:

#### FILTER PASS BAND AND RESOLUTION

Window type	Filter bandwidth at 6dB (freq. bins)	Highest side lobe (dB)	Scallop Loss (dB @ bin)	Noise band width (freq. bins)
Rectangular	1.21	-13	3.92	1.0
von Hann	2.00	-32	1.42	1.5
Hamming	1.81	-43	1.78	1.36
Flattop	1.78	-44	0.01	2.96
Blackman-Harris	1.81	-67	1.13	1.71

#### Definitions

**Filter bandwidth at -6dB** characterizes the frequency resolution of the filter.

**Highest side lobe** indicates the reduction in leakage of signal components into neighboring frequency bins.

**Scallop loss** gives amplitude accuracy of the magnitude spectrum.

**Noise bandwidth** is the bandwidth of an equivalent rectangular filter.

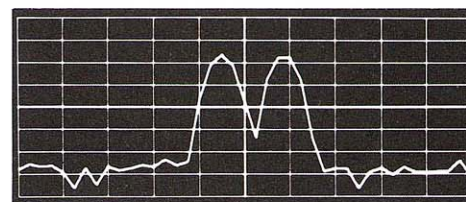
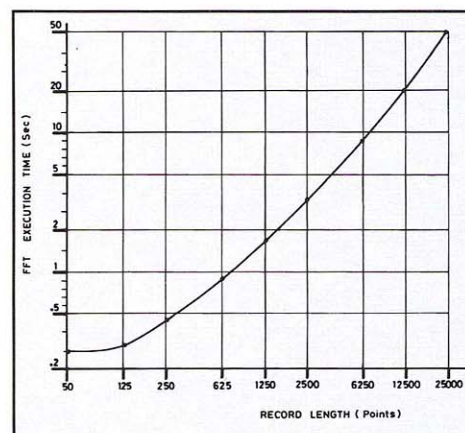

Blackman-Harris

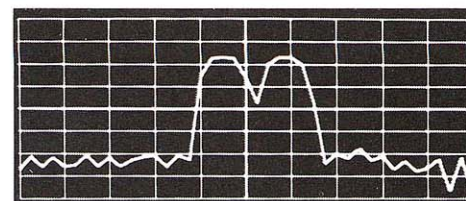

Flattop

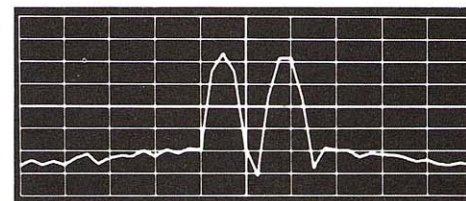

Hamming

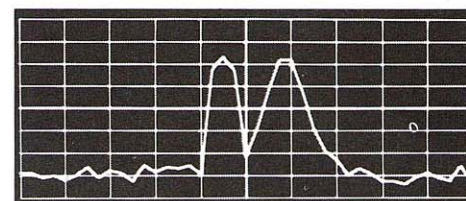

Von Hann (Hanning)

The sum of two 1 V p-p sinusoids of 500 kHz and 527.5 kHz is digitized over 2,500 points and transformed to the frequency domain. Four different window functions are applied to indicate their effect on leakage suppression and spectral resolution. The vertical scale factor is 10 dB/div, 80 dBm full scale.

#### FFT EXECUTION TIME

FFT execution times, including window calculations and display generation, are provided in the graph to the left:



# Portable and Benchtop Digital Oscilloscopes

## REMOTE CONTROL

All front-panel controls and WP01 and WP02 processing functions are fully programmable via the 9400A GPIB and RS-232-C interfaces. Simple English-like mnemonics are used.

## STORED FRONT PANELS

Up to 7 front-panel setups, including WP01 and WP02 menu settings can be stored and recalled by the menu buttons at the left side of the 9400A screen.

## WP02-FFT INSTALLATION

A WP02-FFT package may be retrofit to a LeCroy 9400A Digital Oscilloscope. The WP01 Signal Processing hardware and software is a prerequisite for installation of WP02.

## ORDERING INFORMATION

### Oscilloscope and Options

Code	Description
9400A	Digital Oscilloscope
9400AOP01	High-precision option ( $\pm 1\%$ DC accuracy)

9400AWP01	Waveform processing option
9400AWP02	Fast Fourier processing option (requires 9400AWP01)
9400AMS01	Mass storage and remote control package, including an IBM lap-top controller, interface cables and software.
9400AIM01	GPIB interface for IBM PC computers
OM9400A	Operator's Manual
SM9400A	Service Manual
CS9400	Certified Calibration

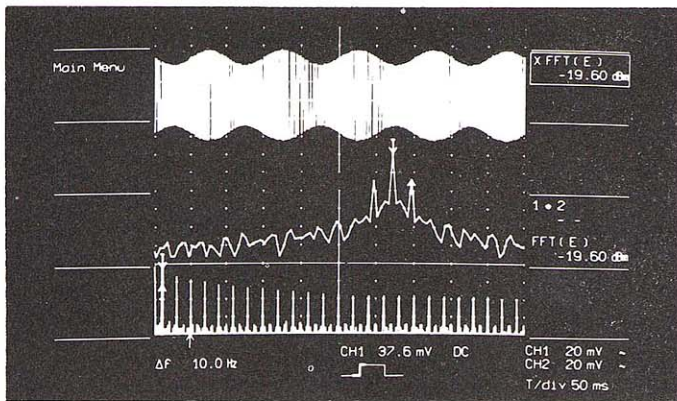

Long records give wide frequency span. FFT of 1000 Hz sine-amplitude modulated square wave shows harmonics up to 51 kHz. Expansion shows sidebands at 10 Hz and -19.6 dBm.

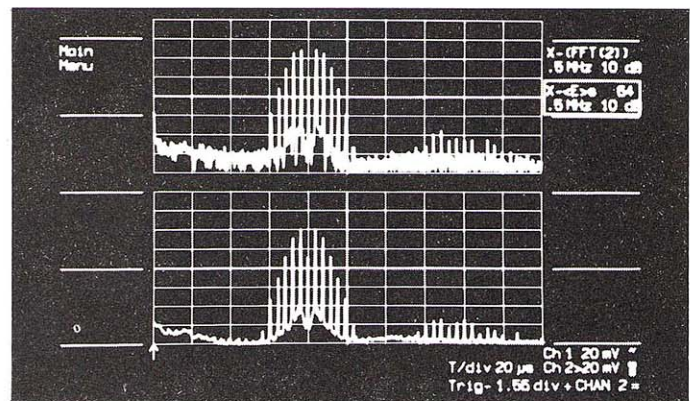

A 2 MHz signal is frequency modulated with a 99 kHz sine wave. To improve the signal-to-noise ratio on the phase-incoherent FM signal, spectral averaging of 64 spectra is used (bottom trace). The part of the spectrum at the right-hand side is the 2nd harmonic of the carrier with sidebands.

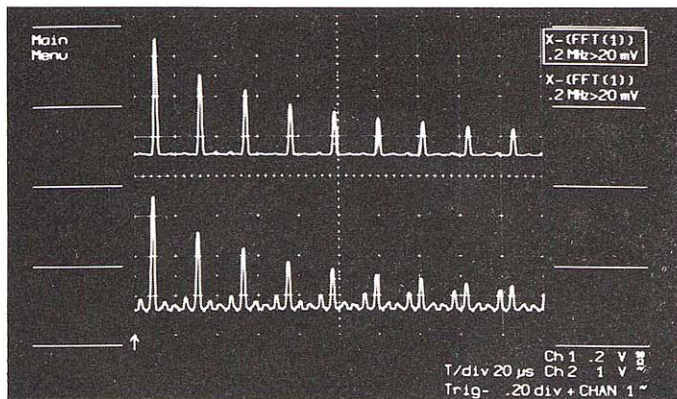

Long records allow higher sampling rates, to reduce aliasing. A 110 kHz square wave is recorded over 1250 and 6250 points with sampling rates of 200 and 40 nsec/point respectively. The bottom trace, a short record transform, has considerable aliasing whereas the longer record transform (top) is alias-free.

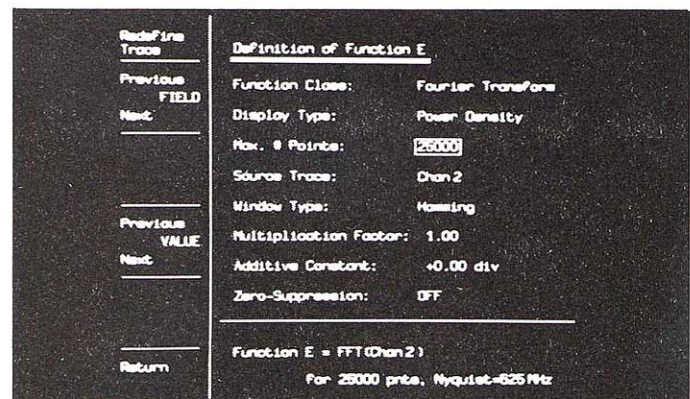

The FFT menu documents all the relevant parameters.



## MS01/MS02 Mass Storage for 9400A Digital Oscilloscope

### Main Features

#### Storage/Retrieval of Waveform Data-

The mass storage package enhances the capabilities of the 9400A oscilloscope by providing storage for large amounts of data for later analysis. Acquired waveforms, waveforms stored in memory, and processed waveforms can be stored and retrieved.

#### Storage/Retrieval of Oscilloscope

**Settings** - All the 9400A front-panel and internal programmable functions (except cursors) can be set, stored and retrieved. Automated sequences of waveform acquisition are also provided.

**Easy-to-Use Menu System** - Single function keystrokes activate storage and retrieval of waveforms.

**Whole or Partial Waveform Storage** - Users may choose to record all or part of a waveform.

**Easy Access to Files** - A directory provides a detailed listing of all the files, including their size as well as the date and time of recording.

**On-line Help Facility** - Users may access "Help" at any time.

**Automatic Warnings** - Diagnostic messages alert the user to errors such as incorrect file names or GPIB errors.

**User's Comments** - Space is provided in the "STORE" menu for inclusion of comments which the user may add to the recorded data.

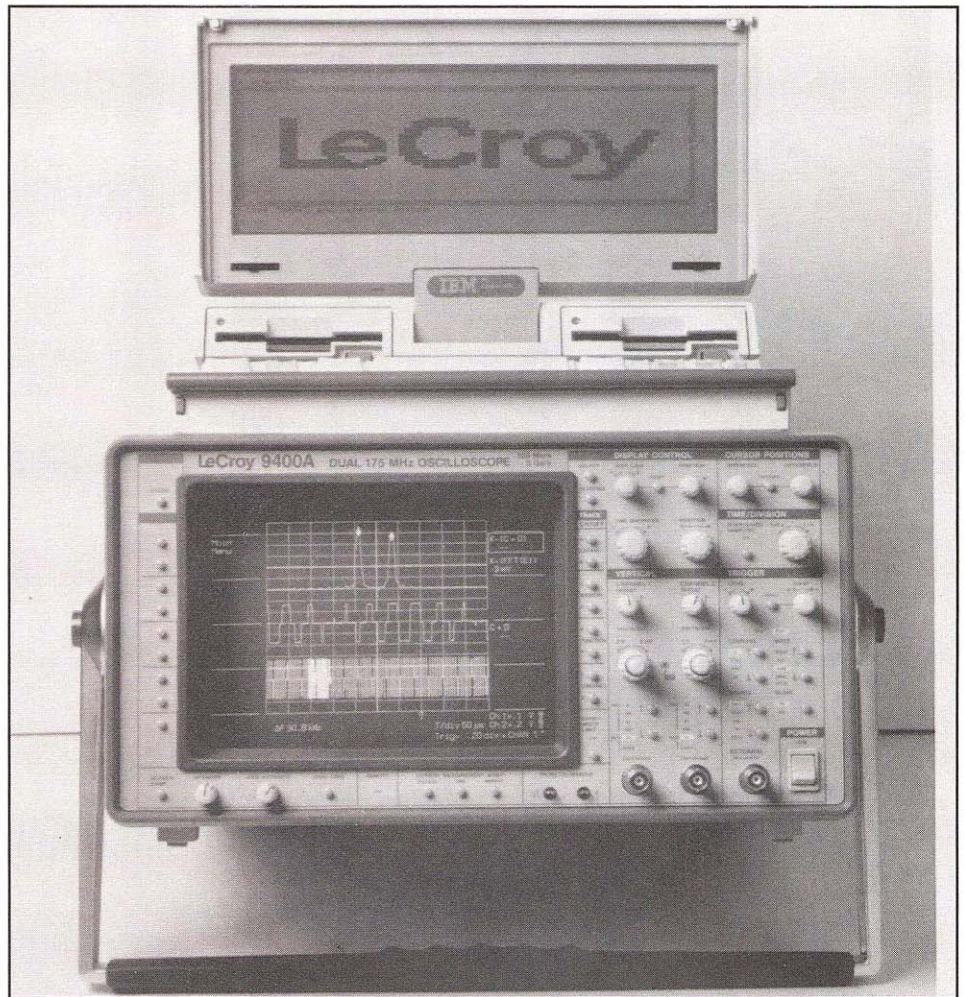

*The MS01 package is easily attached to or removed from the 9400A. It can be powered from the 9400A or a separate AC outlet. Two 3 1/2" floppy disk drives (720 kilobytes each) and a GPIB interface are included.*

#### MS01 Only:

**Programmable Controller** - The MS01 consists of a detachable programmable controller with a flexible disk capacity of 2 x 720 kilobytes/disk, an 80-column by 25-line LCD screen, full keyboard, and GPIB interface.

#### MS02 Only:

**IBM-PC Compatible Software** - The MS02 is compatible with IBM PC's via a National Instruments GPIB interface. It performs multi-trace waveform data acquisition and permits automation of measurements in the laboratory.



## Functional Description

**The MS01 Mass Storage Package** is a comprehensive and fully portable storage/retrieval system, including a programmable controller, for waveforms recorded by the LeCroy 9400A Digital Oscilloscope. Addition of this option broadens the range of applications to field, laboratory, and automated measurement tasks.

With the MS01 Option, the user may store, recall and analyze waveform data recorded in bench-top or field applications. Oscilloscope control settings may also be stored and retrieved. For portable operation, the MS01 option can be powered from the 9400A. File formats on the 3 1/2 inch flexible disk are compatible with any IBM-PC.

Stored waveform files can be converted to ASYST or BCD formats, or to formats compatible with LeCroy's EASYWAVE and CATALYST packages.

For applications that do not require mass storage, the MS01 option may be detached.

**The MS02 Mass Storage Package** is a comprehensive storage/retrieval software for laboratory applications. The MS02 Option combined with an IBM-PC or compatible and a National Instruments Inc. GPIB interface offers all the possibilities of the MS01 Option. Taking full advantage of the capabilities of the IBM-PC, it provides faster processing, color screen displays and control of multiple 9400As. This package supports monochrome, CGA and EGA displays, as well as hard disks.

## OPERATION

MS01 and MS02 provide four basic options: **Store, Recall, Utilities** and **Help**. Windowing permits easy access to sub-menus. Menus are further enhanced with color display, (MS02 only). The Help option is always available and complete diagnostic messages are automatically displayed.

## STORAGE

File names can be automatically generated or specified by the user. Waveform traces and oscilloscope settings may be stored together with comments as required. To store a waveform, the user is prompted to specify the channel, function or memory location in the 9400A. Users may store all or part of a waveform. After each measurement, oscilloscope control settings may be redefined, until a given measurement sequence is completed. These features ensure optimum use of the available storage capacity of the controller.

## RETRIEVAL

Detailed directories simplify file identification and retrieval. Files are labeled by name, size and time of recording. File recognition is further clarified through a file-naming system which automatically adds a three-character suffix for easier association of store waveforms and control settings.

## REMOTE CONTROL MODES

**Batch Mode:** By stepping through front-panel settings and via GPIB addressing, the user may sequentially control from 1 to 15 oscilloscopes. Conditions which

may result in a measurement sequence include a pre-programmed time delay or receipt of a trigger signal.

**Direct Mode:** The 9400A is programmed directly from the keyboard via a GPIB interface. Syntax and programming errors are instantly reported on the screen. Assistance is provided by the help facility.

## CHOOSING YOUR MASS STORAGE PACKAGE

For portable applications, the most suitable configuration is the 9400A oscilloscope with the MS01 package. The MS01 package consists of two principal units:

- 1) the "PC01" Programmable Controller and
- 2) the "IM01" Interface Module which includes a National Instruments GPIB interface, GPIB cable, power cable, Mass Storage Program (MASP), operator's manual and mounting hardware.

For automated measurement applications in the laboratory, the most effective configuration would be the MS02 package with IBM-PCs or compatible systems. A National Instruments GPIB interface must be available in the PC to ensure proper operation. The MS02 package consists of the Mass Storage Program (MASP) and operator's manual. Users must specify the size of the diskette on which the software is to be supplied. The Mass Storage Program makes use of all the processing or hard disk facilities available on IBM Personal Computers.



# Portable and Benchtop Digital Oscilloscopes

## 9400AMS01 Specifications

### 9400AMS01 MASS STORAGE PACKAGE

**Controller:** PC01 programmable controller.

**Medium:** 720 kilobyte 3 1/2 inch flexible diskettes

**Disk Drives:** Two

**Operating System:** MS DOS 3.3.

**Internal Memory:**

384 kilobyte CMOS RAM.

64 kilobyte CMOS ROM.

**Bus Transfer Rate:** 220 kilobytes/sec.

**Display:** LCD; 80 columns; 25 lines.

**Display Buffer:** 16 kilobyte RAM.

**Real Time Clock:** Date and Time.

**Keyboard:** 79 full size keys, 10 function keys.

**Power:** Rechargeable batteries for 6-10 hours operation. MS01 is powered from the 9400A Oscilloscope in portable applications. An international AC power adapter for 110 to 250 V, 50-60 Hz is also included.

**Interfacing:** 9400AIM01 Interface Module including:

- National Instruments GPIB interface, Model 80400-50, attached to the rear side of the PC01
- GPIB cable
- Power cable
- Mass Storage Program (MASP)
- Manual and mounting belt

**MS01 Dimensions:** 2.7 x 12.3 x 15.9 inch, 6.9 x 31.2 x 40.5 cm. **Weight:** 13 lb; 6 kg.

### 9400A MS02 MASS STORAGE PACKAGE

**Controller Compatibility:** IBM-PC and compatible models with memory capacity of 384K or higher, MS DOS 2.1 or higher.

**Bus Transfer Rate:** Up to 400 kilobytes/sec.

**Interface Requirement:** National Instruments GPIB/PC-2 or PC-2A installed in Personal Computer.

**Software:** Mass Storage Program (MASP) including manual.

**Data Medium:** Size of diskette 3 1/2 or 5 1/4 inch.

### MASS STORAGE MODES

**Full Waveforms:** Waveform (Channel 1, 2; Memory C, D; Function E, F) to be transferred must be specified.

**Partial Waveforms:** First and last position to be specified in % of screen width: (0%: left edge of grid; 100% right edge of grid).

**Number of Data Points:** Enable the user to select only every nth data point, where n is an integer (1, 2, 3, etc.).

### ORDERING INFORMATION

Model	Description
9400A	General Purpose Digital Oscilloscope

### Options

9400AOP01	High Precision $\pm 1\%$ DC accuracy.
9400AWP01	Waveform Processing Package.
9400AWP02	Fast Fourier Processing Package.
9400AMS01	Mass Storage Package including: - PC01 "Programmable

9400AIM01	Lap-top Controller", - National Instruments GPIB Interface + software + cable, - Mounting belt, - Mass Storage Program (3 1/2" diskette), - Operating System MS DOS 3.3. GPIB Interface Module, Mass Storage Program, connecting cable and instruction manual to integrate a "Programmable Controller" with the 9400A when purchased separately.
9400AMS02	Mass Storage Program (3 1/2" and 5 1/4" diskettes) for existing 9400 users.

### Accessories

6900 IC	National Instruments GPIB/PC-2 interface card for IBM-PC and compatible.
DC/GPIB-2	GPIB cable, length 2 meters

### WARRANTY

Two years for parts and labor on Model 9400A + Options OP01, OP02, WP01, WP02 and MS02.

Three months for parts and labor on options 9400AMS01 and 9400AIM01.

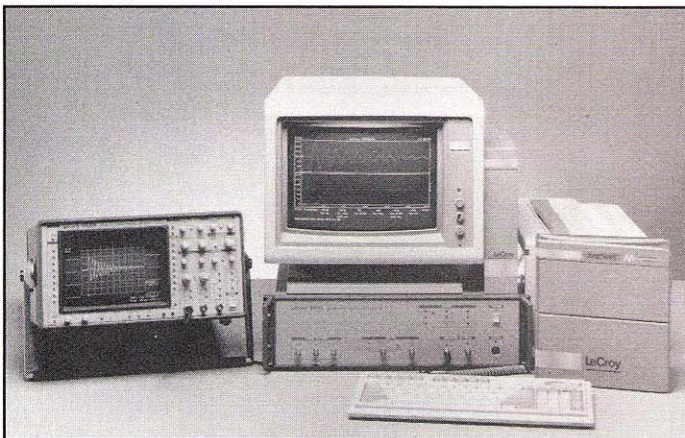

LeCroy's EASYWAVE® advanced signal processing software is fully compatible with the Mass Storage Packages.



The MS02 Storage package, operating with a color IBM-PC, provides storage/retrieval capabilities and low-cost system automation with multiple 9400As.



## CS01 Calibration Software Packages for 9400 Series Digital Oscilloscopes

### Main Features

- Computer Controlled Verification of the Important DSO Specifications
- Traceability to Reference Standards
- Computer Aided Readjustment
- Software Compatible with the IBM-PC® Standard

### Complete Check and Adjustment

#### FUNCTIONAL DESCRIPTION

The LeCroy test and calibration software provides a convenient, unambiguous check of LeCroy's DSOs specifications. Designed to benefit users who require traceability to reference standards (NBS), this package is ideally suited for use in calibration laboratories where these DSOs are checked at fixed intervals.

Results of the calibration check are fully documented on hard copy, or they can be archived on hard disk or diskette. This software works on any PC compatible with the IBM-PC® standard. It remotely controls the DSO under test and the calibration sources through a National Instruments Inc® . GPIB interface.

#### CALIBRATION PRACTICE

LeCroy DSOs are auto-calibrating digital oscilloscopes and therefore do not require regular calibration like analog oscilloscopes. However, for users who

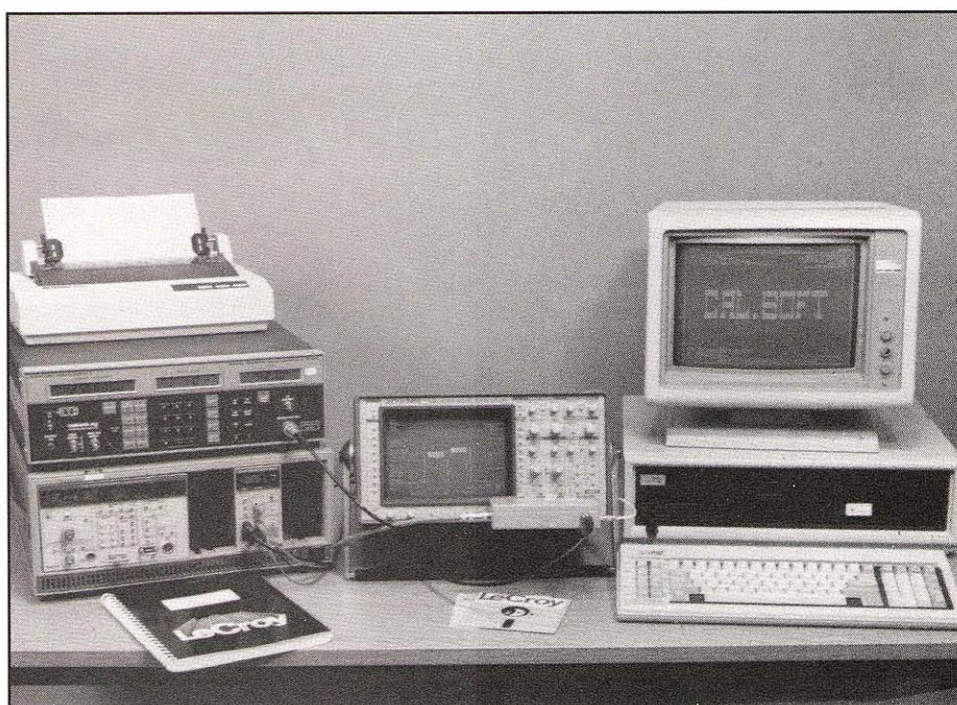

require traceability to reference standards (such as those provided by the National Bureau of Standards), and for calibration laboratories which must inspect incoming instruments and perform recalibration at prescribed intervals, the CS01 computer-aided test and calibration package provides an easy solution.

Under guidance of this program, some adjustments to the DSO can be made by an electronics technician. However, major deviations from specifications usually require repair by a trained service engineer. LeCroy regularly schedules classes to train engineers. If no in-house trained person is available,

the nearest LeCroy service center can carry out repairs and calibration, and provide traceability to reference standards.

#### USING THE LeCroy CALIBRATION PACKAGES

For calibration checking, digital oscilloscopes have a great advantage over analog oscilloscopes because waveforms can be transferred to a host computer. This simplifies the calibration procedure enormously, makes it potentially faster, and allows an extensive range of tests with unambiguous interpretation of the results.



---

# Portable and Benchtop Digital Oscilloscopes

---

The calibration packages perform an extensive series of tests which verify the specifications of the DSO. This includes many tests relevant to analog scopes such as Noise and Linearity tests. Although these tests are difficult and time consuming to do on an analog oscilloscope, they can be computer controlled and are quickly and easily performed on a digital oscilloscope. Tests which are specific to digital oscilloscopes, such as Sinefit tests are also included.

The various test possibilities are presented to the operator in the form of a simple menu system. The user has the choice of performing an automated calibration check of the oscilloscope, or individually testing any of the specifications. Some of the tests require the use of high-quality external signal generators. The user receives instructions on the screen when it is necessary to change the cable connections, but apart from this minor intervention, the tests are fully computer controlled when GPIB programmable instruments are used.

## RECOMMENDED ACCESSORIES

The software works on any PC compatible with the IBM-PC standard and equipped with a mathematical coprocessor and a National Instruments Inc. GPIB interface. An automated check of the calibration is possible using the following external instruments:

- (1) Marconi 2019A or 2022 Sine Wave Generator  
or  
Hewlett Packard 8642 A/B Synthesized Signal Generator  
or  
Fluke 6060B  
or  
Rhode & Schwarz SMX
- (2) Tektronix PS5004 High Precision Power Supply
- (3) Tektronix CG5001 Calibrator for voltage step generation
- (4) WWV or HBG1500 OSTRAC Frequency Standard Receiver

For an automated calibration check, one LeCroy Programmable Multiplexer is required to multiplex the generated signals to the inputs of the oscilloscope. A full calibration kit can be ordered from LeCroy for calibration or repair activities. It includes all the necessary cables, adapters, splitters, filters and board extenders for computer-aided adjustments, as well as the Programmable Multiplexer.

## USE OF OTHER INSTRUMENTS

It is also possible to perform the calibration check with other signal sources. However, the user is then required to set up these instruments manually and to perform one measurement at a time. The packages guide the user step by step, and control the DSO, the data acquisition, and the computation of the results.

The signals measured by the oscilloscope are compared with the signal it would expect to receive from the generator. Warning messages are displayed whenever tolerances are exceeded. Some of the adjustments may be carried out by the user when the test sequence is finished. In this case the software will guide the user through the correct adjustment procedure. At the end of the calibration check, a printout can be generated to list the results.

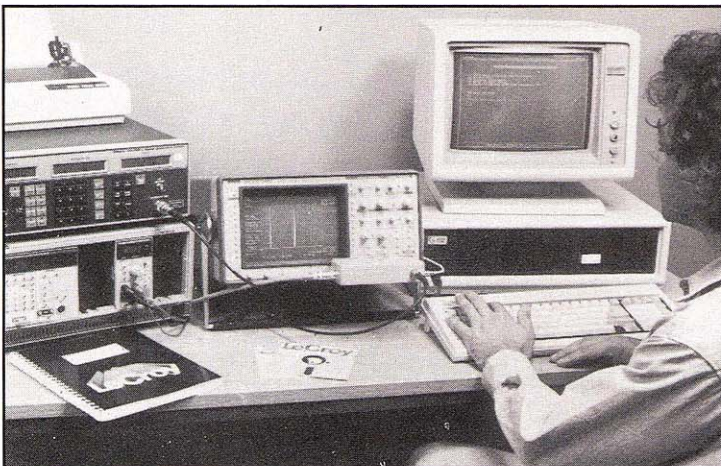



## CS01 Specifications

**Computer Required:** Any PC compatible with the IBM-PC standard, and equipped with a mathematical coprocessor and the National Instruments Inc. GPIB interface, can be used.

**Language Used:** C

**Operating System:** DOS 3.0 upward

**Medium:** 5 1/4" or 3 1/2" diskette

### MAJOR TESTS SUPPORTED BY THE CALIBRATION

#### Bandwidth:

To calculate the bandwidth, the amplitudes of sine waves of increasing frequencies are measured.

This test is executed on all channels for 1 M $\Omega$  and 50  $\Omega$  input impedance and for all vertical sensitivities. It requires a sine wave generator with a frequency range up to 500 MHz, excellent flatness and high spectral purity.

#### Linearity:

Different known DC voltages, varying from 5% to 95% of full screen, are applied by the external voltage reference source. For each voltage value, the DSO acquires a trace. The mean value of the data points is compared to the known input voltage. The linearity is determined through a linear regression fit to the measurements. The slope, the offset and the chi-square of the fit are computed.

With the linearity test, many other related tests are performed: accuracy of the probe calibrator, response time of the overload protection of the 50  $\Omega$  input, linearity of the variable gain calibration, range and linearity of the offset setting, and quality of the input coupling.

The procedure is executed on all channels for both 1 M $\Omega$  and 50  $\Omega$  input impedance. The test requires a DC source with a precision and time stability of 0.1%, a voltage range of 0 V to 20 V adjustable in steps of 5 mV, and an output current capability of 300 mA.

#### Noise:

The noise tests are executed on all channels for both 1 M $\Omega$  and 50  $\Omega$  input impedance, with AC and DC input coupling, different time-base settings. Data points are measured for different offset values. The peak-to-peak as well as the RMS values of each measurement are computed, and the maximum values are recorded. The program also indicates the occurrence of any "flyers", i.e. short noise peaks generated by the ADCs.

The noise tests also include:

- checking the linearity of the variable offsets of both channels between 2.5% and 97.5% of full screen.
- checking the stability of the ground line when switching the inputs between GROUND and DC coupling modes.

#### Rise Time/Overshoot:

Executed on all channels for all 1 M $\Omega$  and 50  $\Omega$  input impedance, these tests measure the rise time of the oscilloscope response to the input voltage step, as well as the amount of pre-shoot and overshoot. They require a voltage step generator with a calibrated fast rise time of the order of 500 psec and 1 V amplitude.

#### Sinefit:

The performance of the analog-to-digital converter is evaluated in terms of the number of effective bits (a measure of the signal-to-noise ratio). It is measured on all channels, at a sensitivity of 50 mV/div, by applying pure sine waves at a set of reference frequencies:

This test is a measurement of dynamic linearity. It shows the effect of such errors as noise, non-linearities and aperture jitter.

#### Time Base:

The time-base test compares the internal clock with a very precise and stable external time base reference (clock generator) such as the WWV standard or HBG 1500.

#### Trigger:

The trigger capabilities are tested for all possible configurations of:

- trigger sources
- couplings
- level, and slopes settings.

If relevant, the external trigger is also measured, as well as the different combinations of the SMART trigger facility.

#### Miscellaneous:

The miscellaneous tests include:

- The cross talk between the trigger input and the signal inputs, and the cross talk between the signal inputs.
- The feed-through of the input coupling commutation relays.
- The propagation time difference between the channels.



# Portable and Benchtop Digital Oscilloscopes

## 7200 Series Precision Digital Oscilloscope

### Main Features

- Modular - Expandable
- Simultaneous digitizing - 4 channels at 1 GS/sec for transients or 20 GS/sec for repetitive signals
- 400 MHz bandwidth
- 50k waveform memory per channel
- 1000 waveform mass storage built-in
- FFT, math, pulse parameters, statistics

The LeCroy 7200 is a powerful, expandable, digital oscilloscope with complete analysis functions. With the 7242 plug-in, it becomes a 2 or 4 channel, 400 MHz, precision oscilloscope. The 7200 has more computing power than any other digital oscilloscope available today.

### AN OSCILLOSCOPE YOU KNOW HOW TO USE

The 7200 feels like an analog oscilloscope. The screen updates almost instantly with new waveform data. The controls are knobs and buttons. You know how to use it right away.

The 7200 can precisely digitize both transient and repetitive signals. You can measure the digitized waveform data with cursors, compare it to previously recorded data, analyze it, hardcopy it, or store it to a built-in floppy disk.

Plus, you can quickly configure the oscilloscope to your most commonly

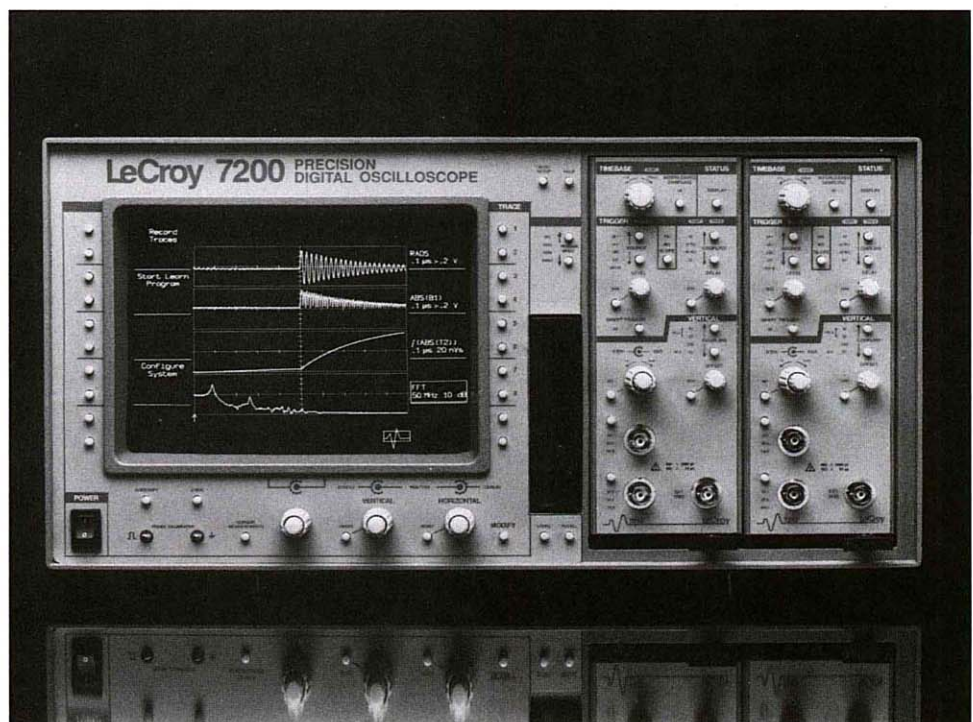

used settings. Just recall them from a "personal" front-panel settings disk.

### MODULARITY

Expand channels at any time. The plug-ins are digitizing sub-systems, complete with ADCs, trigger facilities, and memories. Therefore, the 7200 digital oscilloscope can grow as your needs change and as technology advances.

With additional plug-ins, a single 7200 can solve different measurement problems requiring extremes in sample rate, bandwidth, resolution, or number of channels. The oscilloscope automatically configures and calibrates itself to accommodate the module(s) you install.

The recallable front panel settings make multiple applications easy.

Expansion is simple. Insert another plug-in and connect your probes or signal cables. You can operate the second plug-in with independent timebase and trigger setups or synchronize it with the first plug-in.

### MULTIPLE CHANNELS, MULTIPLE TRACES

With a second 7242 plug-in, the 7200 provides 4 channels of simultaneous 1 GS/sec (gigasample per second) digitizing for transient signals. The 7200 clearly displays 1 to 8 traces of "live," stored, or analyzed waveforms.



# Portable and Benchtop Digital Oscilloscopes

## 7242 PLUG-IN

7200 series plug-ins contain much more than amplifiers and front end circuitry. A single 7242 plug-in provides the following for each of its two channels:

- 400 MHz bandwidth
- 1 GS/sec, 8 bits for transient signals
- 20 GS/sec, 10 bits for repetitive signals
- 50k waveform memory per channel
- SMART TRIGGER™ (pattern, interval, pulse, TV, and others)

## COMPLETE ANALYSIS

The 7200 Oscilloscope is a complete measurement and analysis instrument which captures waveforms and extracts their information content. Built-in capabilities (without an external computer) include:

- Up to 8 waveforms analyzed and displayed simultaneously
- > 20 waveform math functions
- Spectrum analysis with 100 to 50,000 point FFTs

- Waveform parameters with statistics and trending
- Custom PASS/FAIL testing

The 7200 quickly responds with updated answers as soon as you acquire new waveforms.

Time domain features include automatic readout of pulse characteristics, X-Y plots, and waveform math.

Waveform parameters can be histogrammed or trends plotted.

Single waveform math operations include absolute value, square, square root, log, antilog, integral, differential, 1/x, smoothing, averaging, floor, roof, and extrema. Multiple waveform math includes sum, difference, multiply, and divide.

Frequency domain analysis includes the Fast Fourier Transform (FFT) and its inverse, with displays of phase, magnitude, power spectrum, cross-spectrum, and other functions. The 100 to 50,000 point FFT's provide high resolution frequency measurements.

## MASS STORAGE

The 7200 contains both a built-in hard disk and floppy disk drive for storing waveforms, screen dumps, and front panel settings. Stored waveforms can be analyzed, compared, and transferred over GPIB or RS-232C, just like "live" waveforms. Built-in mass storage provides:

- Convenient data transfers to a host computer via MS-DOS format floppies
- 2 Mword waveform buffer
- "Personal" waveform/settings diskettes for each operator
- Simple waveform graphics transfers to desktop publishing packages

## ACCURATE SINGLE-SHOT MEASUREMENTS

For events that occur only once, the 7242 digitizes at 1 GS/sec. This fast digitizing rate provides excellent time resolution for waveforms from fast TTL,

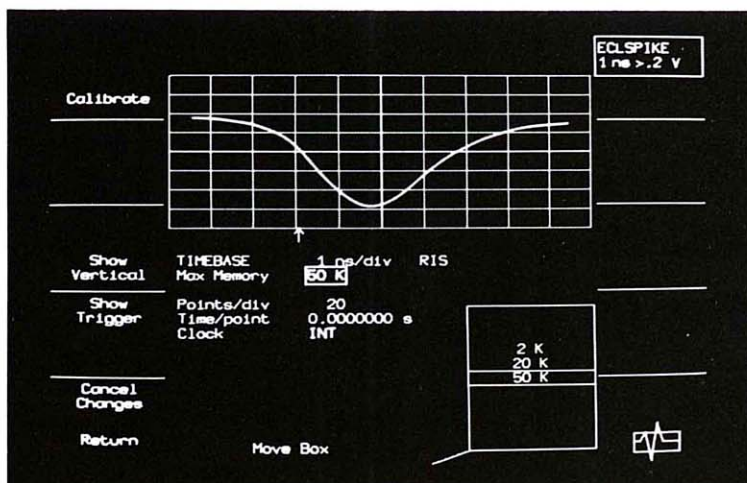

For repetitive signals, vertical resolution is up to 0.09% at full 400 MHz bandwidth. You get all the details with clarity.

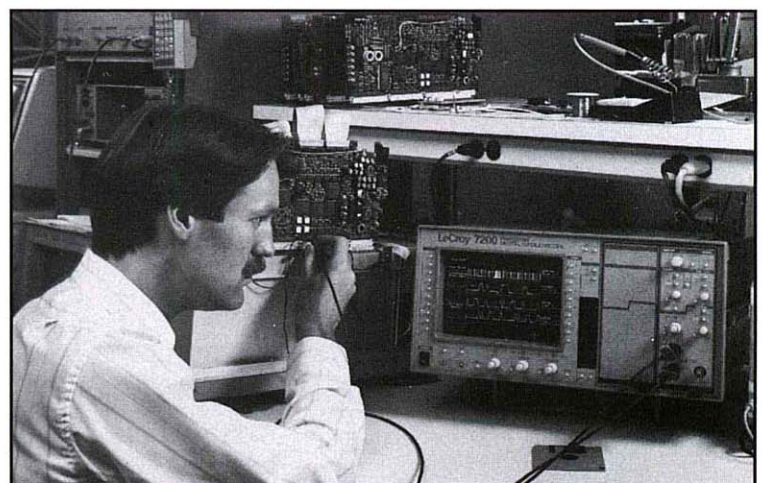

The 7200 is a complete oscilloscope, optimized for precision measurements. Its familiar operation places ready answers at your fingertips.



# Portable and Benchtop Digital Oscilloscopes

ECL, and GaAs circuits, communication signals, pulsed-laser responses, electromagnetic pulses, and other high speed phenomena. Selectable pretriggering allows you to see what occurred before the trigger.

## ACCURATE REPETITIVE MEASUREMENTS

For waveforms that repeat, the 7242 has a random interleaved sampling (RIS) mode which effectively digitizes at 20 GS/sec. This dramatic oversampling provides you with extremely accurate pulse parameter measurements. Since the sample points are only 50 pico-seconds apart in the digitized waveform, the 7200 displays a very accurate digital rendition of the input signal. Pre-trigger data is available in the RIS mode.

## VERTICAL RESOLUTION MODES

High vertical resolution plus advanced display algorithms provide smooth waveform displays from digitized data and expose small signal details. 7242 resolution lets you expand vertically to closely examine overshoot and small signal anomalies.

## MORE MEMORY FOR MORE BANDWIDTH, MORE PRECISION

The 7242 digitizing plug-in contains a 50,000 sample waveform memory per channel, and the 7200 displays it all. The long memory allow you to use higher sampling speeds at longer timebase settings than any other digital oscilloscope. Long waveform memory equates to more closely spaced digital samples, more usable bandwidth, and hence, better waveform definition.

Even on the 5  $\mu$ sec/div timebase setting, a single-shot digitized waveform is represented by 50,000 samples

*The 7242 contains one 8-bit digitizer per channel. Using real-time digital filtering, you can trade bandwidth for resolution as shown. For repetitive signals, resolution can be further enhanced with signal averaging.*

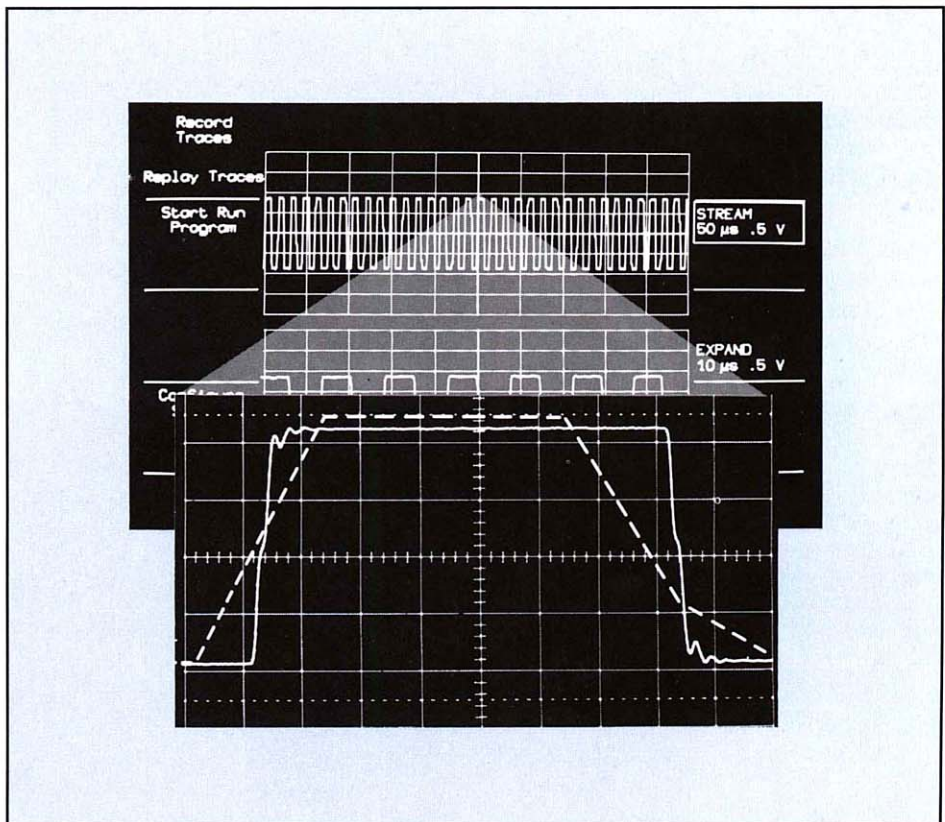
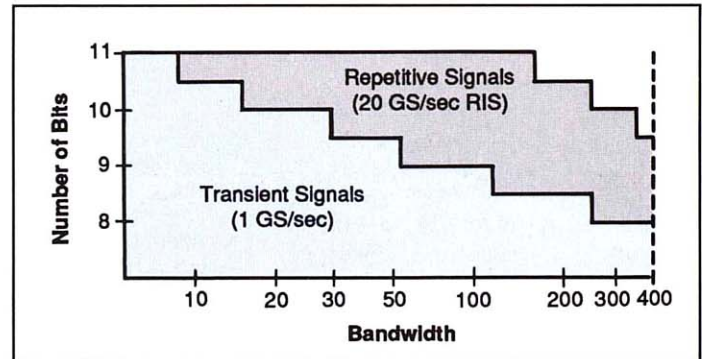

*The solid line depicts 7242 performance. The 50,000 sample waveform memory lets you use the 7200 without concern for loss of waveform details as you change timebases. In contrast, short-memory digital oscilloscopes (dotted line) must reduce their sample rate on slower timebases.*



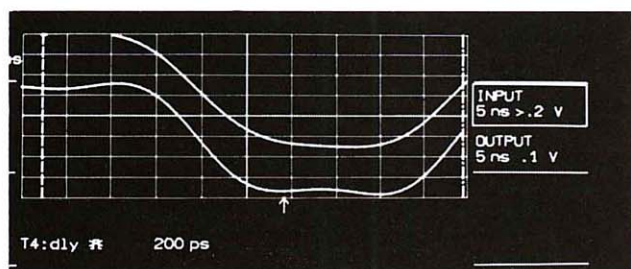
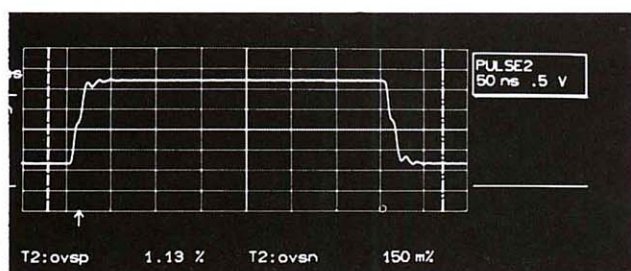

The 7242 fast RIS sample rate, high vertical resolution, and deep waveform memory capture more signal details. These details result in very accurate waveform parameter calculations.

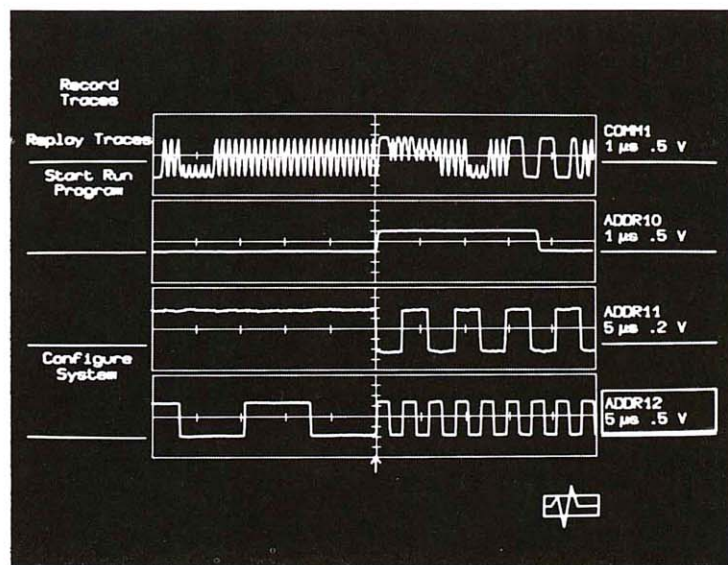

SMART TRIGGER lets you view conditions in a microprocessor-based system under user selectable logic states such as a particular address or data value. You can also delay from the condition by a selectable time or number of events.

spaced 1 nsec apart. Most other high speed digital oscilloscopes only show 500 points out of a longer record.

Thanks to LeCroy's unique display compacting method, you always see the full 50,000 sample record represented on screen. The 7242 delivers up to 100 times better resolution and usable bandwidth on most timebase settings than other leading oscilloscopes!

## TRIGGERING TO CAPTURE ELUSIVE EVENTS

SMART TRIGGERing lets the 7200 capture a waveform on various conditions. Trigger on a particular data or address condition in a microprocessor-based system by setting logic threshold levels for the inputs and setting logic

conditions (CH1, CH2, EXT TRIG) to trigger on. Capture a dropout glitch in a clock signal or find the missing bit during a disk drive read using pulse-width triggering. Or, wait for a specified number of event occurrences and then trigger. Its finally your choice.

## CONVENIENT DATA TRANSFERS

The 7200 eliminates the need to write GPIB programs to transfer waveforms to your PC. The 7200 floppy drive uses MS-DOS formatted diskettes. To transfer waveforms, just store them to a floppy. Then remove the diskette and insert it in your PC. The data is transferred.

Pressing the RECALL button displays diskette-stored waveforms for comparison, analysis, or hardcopy. Plus, each

operator can use "personal" settings diskettes to quickly set up his/her often-used configurations.

## A SCOPE THAT REMEMBERS

No more backtracking to reconstruct an event because you didn't note it the first time you saw it. The special "Record Traces" feature automatically stores every waveform as it is displayed into a non-volatile buffer (2 Msamples). To review a past event, just press a button and enter the "Replay Traces" mode. Scroll through events (time stamped) until you find the one you're interested in. Then analyze it, save it to floppy, or hardcopy it just like it was a "live" waveform.



# Portable and Benchtop Digital Oscilloscopes

## UP TO 16 SIMULTANEOUS CALCULATIONS

The 7200 can display up to 8 traces. Each trace represents either raw waveform data or a waveform modified by calculation(s). For each trace, one or two analysis functions (math, FFT, etc.) can be applied to the data. So, eight separate signals can be analyzed simultaneously. Or, the analyses can be chained for up to 16 cascaded calculations on one signal!

## ANSWERS IN THE FORMAT YOU NEED

Single trace math functions, multiple trace operations, scientific units, and user-defined labels provide answers in the format you need.

For example, measure the voltage across a resistor on your circuit board and read out in milliAmps. Integrate a current waveform to obtain electrical charge (Coulombs) vs time. Differentiate a velocity measurement to display acceleration. Accentuate the difference between waveforms by subtracting one from the other. Multiply voltage times current and display power in Watts.

## WAVEFORM PARAMETERS, TRENDING, AND HISTOGRAMMING

Automatically calculate and display 14 basic waveform parameters on any one trace. Or choose up to 20 parameters from a complete selection and distribute them in any fashion amongst the displayed traces. Either way, the super-accurate parameters update on screen as fast as you can read them. To optimize accuracy, the 7200 employs up to 50,000 samples when calculating waveform parameters.

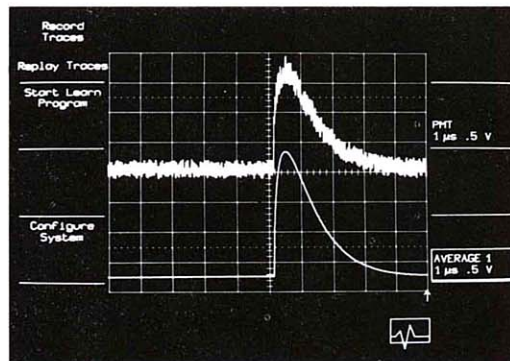

Signal averaging enhances vertical resolution and reduces uncorrelated noise. The signal must be repetitive with a stable trigger point. The 7200 averages over 100 waveforms per second.

*Pulse width jitter can cause serious problems in some designs. The 7200 lets you detect jitter in one of several ways: 1) with a roof/floor envelope, 2) variable persistence display, or 3) a pulse width histogram. Shown here is a roof/floor envelope, also called extrema.*

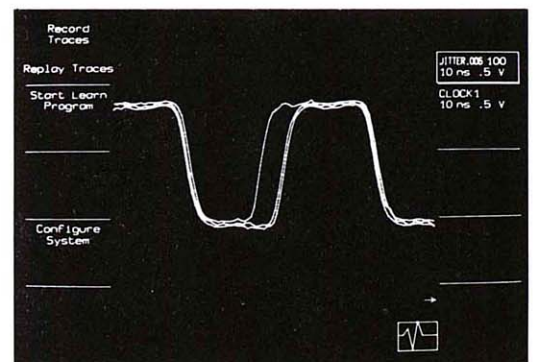

Trending and histogramming further enhance this measurement power. For example, plot a parameter against time on the screen to easily monitor temperature effects of your circuit as you apply a heat gun. Print out a histogram of measurements from an entire test lot for statistical quality control reporting.

## WAVEFORM OR SPECTRAL INFORMATION

Frequency spectrum analysis, signal averaging, and roof/floor enveloping help you extract the information of

interest - even when it is modulated, jittering, harmonically distorted, buried in noise, or drifting.

Spectrum analysis exposes signal information which can be difficult to discern in the time domain. Such signals include a sine wave with phase noise, with frequency modulation, or with harmonic or intermodulation distortion. The 7200 spectrum analysis includes both the FFT and IFFT.



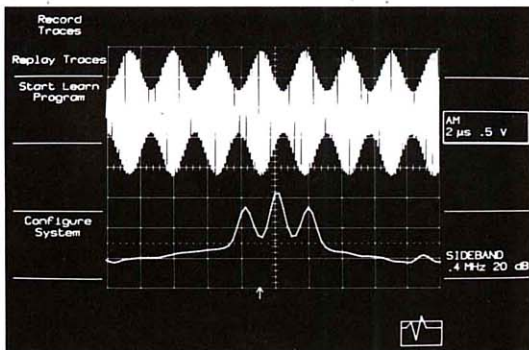

*Spectrum analysis can expose signal details which are difficult to detect in the time domain. Choose the spectral resolution you want by changing the size of the transform from 100 to 50,000 points.*

## UNATTENDED MONITORING AND AUTOMATED TEST

The 7200 can automatically run tests while you pursue other tasks. It can even monitor for elusive transients of interest! Once detected, it can capture, time stamp, test, and conditionally save the waveforms to disk - even when you are not there. Tests include waveshape out-of-limit checks, up to 20 pulse parameter measurements on up to 8 traces, and any logical combination of the above.

The 7200 reduces test time. When integrated into an ATE system, its extended processing and local program execution features let you transfer answers, not block data.

## LEARN MODE

The 7200's Program Learn Mode simplifies operation when running repetitive tests. It records any sequence of front panel operations as a program. An operator can start this program, and the 7200 will execute these commands flawlessly, time after time.

Learn mode also serves as an on-line help to GPIB programming. The Learn Program commands and the GPIB commands are identical. Thus, a GPIB

program can be outlined by creating a Learn Program. Then store it to disk, and load it into a PC for completion.

## ADVANCED ATE SYSTEM OPERATION

The 7200 is fully programmable from a computer with a GPIB port or from an RS-232C terminal. Bus commands can set up the instrument, control cursors, and readout data.

The fast GPIB data transfers and local data reduction cut overall testing time.

*When used within a larger ATE system, processing inside the 7200 reduces data transfers and therefore test times. Shown here, during a device propagation delay test, the 7200 reads out just the result, not two waveform data blocks.*

The 7200 transfers waveform data blocks at up to 600 kbytes per second. Local processing and decision making provide for PASS/FAIL result readouts. The 7200 executes custom programs for conditional testing without a host computer connected.

## SPECIAL PURPOSE TESTING

Off-line PC programming lets you generate 7200 executable programs. When executed, these programs customize the 7200 to make decisions internally, so it operates as a special-purpose tester. For example, it could operate like a dedicated spectrum analyzer, frequency drift monitor, time domain reflectometer, incoming inspection tester, data logger, trend monitor, or almost any other measurement instrument thinkable. Just change the program and the 7200 becomes another instrument. Custom menus let the operator select from various tests or testing parameters.

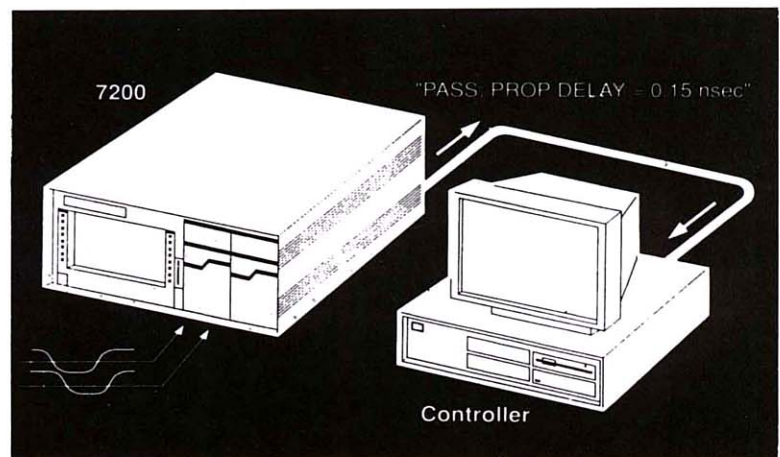



# Portable and Benchtop Digital Oscilloscopes

## 7200 Specifications

### 7200 Series Architecture

Plug-in includes amplifier, trigger circuitry, timebase, waveform digitizer, etc. Mainframe includes two plug-in slots, ports, floppy disk, hard disk, signal processors, display, etc.

### 7242 Plug-In Specifications

**Channels:** 2

**Channel Settings:** Independent gain, offset, coupling, probe attenuation, enhanced resolution, and BW limit. Timebase and triggering are common to both channels.

**Analog Bandwidth:** 400 MHz minimum

**Gain Accuracy:**  $\pm 2\%$  at DC

**Input Coupling:** AC, DC, or DC/50  $\Omega$

**Input Protection:** 7 VDC on 50  $\Omega$  input; 250 VDC pk on 1 M $\Omega$  input

**Waveform Memory:** Selectable 2k, 20k or 50k samples

**Pre-trigger:** 0 to 100%, continuously settable

**Segmentable Memory Mode:** Memory is divided into 2 to 100 segments. Each segment is 250 to 25,000 samples long and contains a trigger point time stamp (1 nsec resolution).

#### VERTICAL

**Single-Shot Resolution:** 8 bits at 400 MHz BW, 11 bits at 8 MHz BW, selectable in 0.5 bit steps

**Repetitive Resolution:** 9.5 bits at 400 MHz BW, 10 bits at 330 MHz, 10.5 bits at 240 MHz, 11 bits at 150 MHz; more with averaging

**Offset Range:**  $\pm 12$  divisions typical, continuously variable

**Input Sensitivity:** 5 mV/div to 1 V/div in a 1,2,5 sequence, to 2.5 V/div using calibrated variable gain

**Sample Clock:** Internal or external

#### SMART TRIGGER

**Trigger Modes:**

**Auto:** Automatically rearms and triggers after each sweep

**Normal:** Rearms after each trigger

**Single:** Arms for a single trigger and holds display after trigger occurs

**Sequence:** Stores multiple events in segmented acquisition memories

**Sources:** EXT, EXT/10, CH1, CH2, or LINE. CH1, CH2, and EXT have independent slope, coupling, and level settings.

**Slope:** Positive, negative

**Coupling:** AC, DC, LF reject, HF reject

**External Source:**  $\pm 2.5$  V or  $\pm 25$  V ranges

**Settability:** 0.6 mV or 6 mV

**Overload Protection:**  $\pm 250$  V overload for 0.5  $\mu$ sec

**Internal Source:**  $\pm$  full scale input range

**Settability:**  $\pm 0.025\%$  of full scale

**Level Accuracy:**  $\pm 3\%$  of full scale (DC coupling only)

**Delay:** Up to 680 sec

**Single Source Conditions:**

**Hold-off By Time:** 30 nsec to 680 sec

**Hold-off By Events:** 1 to  $10^{10}$  events

**Pulse Width:** Triggers on opposite slopes of pulses narrower or wider than a specified limit of 1 nsec to 680 sec.

**Interval Width:** Triggers on same slopes of signal intervals narrower or wider than a specified limit of 30 nsec to 680 sec

#### Multi-source Conditions:

**Pattern:** Triggers on entering or exiting a specified CH1, CH2 and EXT, EXT/10 logic pattern (low, high, don't care). The trigger can be held off:

- 1) by a selected time or number of events, OR
- 2) until a selected interval width occurs, OR
- 3) until a selected time between patterns occurs.

**State Qualified:** Triggers on a CH1, CH2, or EXT, EXT/10 source while a specified pattern of the other two sources is present or absent. A delay by time or number of events can be selected from the moment the pattern is valid.

**Time Qualified:** Triggers after entering or exiting a specified CH1, CH2, and EXT, EXT/10 logic pattern (low, high, don't care) and after a selected delay by time or number of events from the moment the pattern is valid.

**TV Triggering:** Up to 65 kHz scan rates

### 7200 Mainframe Specifications

#### MULTIPLE PLUG-IN CONFIGURATION

**Timebases:** Independent or locked (master/slave)

**Triggers:** Independent or locked (master/slave)

#### DISPLAY

**CRT:** 9 inch (23 cm) diagonal, vector type

**Resolution:** 2000 vertical x 500 horizontal points (trace area)

**Grids:** Single, dual, quad, or octal. Single contains 10 horizontal and 8 vertical divisions.

**Traces:** 1 to 8

**Waveform Display:** Straight line or  $\sin x/x$  interpolation. A max/min algorithm exposes all the waveform glitches and spikes when the acquired waveform contains more sample points than the CRT can display.

**Variable Persistence Mode:** Overlays a selected number of most recent traces (1 to infinity).

#### AUTO SETUP

Automatically scales the timebase, trigger, and gain settings to provide a stable display for repetitive signals.

Requires 2 mV to 8 V pk-pk,  $> 50$  Hz,  $> 0.1\%$  duty cycle.

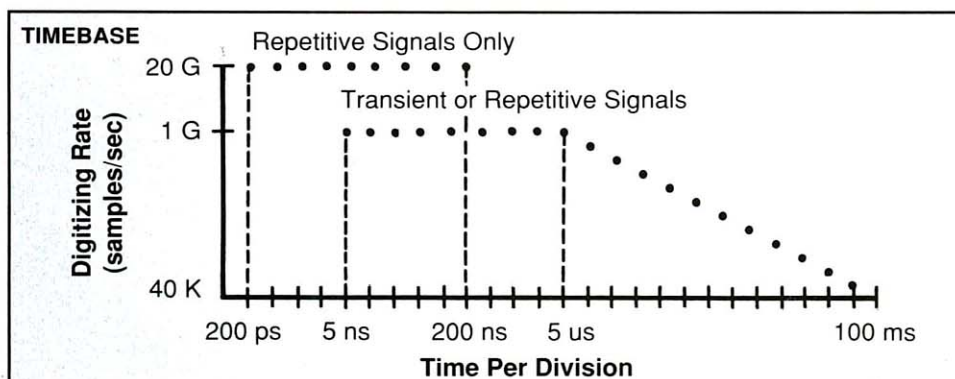



# Portable and Benchtop Digital Oscilloscopes

## MASS STORAGE

**Hard Disk:** Built-in storage for 2 million sample points (e.g. one thousand 2000-point traces). Traces are sequentially numbered and time stamped. Storage time for 50,000 point waveform is approximately 1 second. Storage is non-volatile. Also stores 10 front panel setups.

**Floppy Disk Drive:** Each diskette provides 720 kbytes of portable storage in MS-DOS format. Each diskette stores approximately 310 ksamples of waveforms, or up to 10 front panel setups, or a combination.

**On-line Manual:** Complete description of every function and operation, indexed.

## CURSORS

**Marker Cursor:** Reads absolute time or frequency and voltage.

**Vertical Cursors:** Reads absolute or delta amplitude.

**Horizontal Cursors:** Reads delta time or frequency and voltage.

## SIGNAL ANALYSIS FUNCTIONS

**Math Functions:** +, -, X, /, sinx/x, enhanced resolution, negate, 1/, d/dt, integral, square, square root, log, log 10, exp, exp 10, abs, value, smoothing (1,3,5,7, or 9 point), floor, roof, extrema (both floor and roof), etc.

**Engineering Units:** %, dB, ppm, degrees Kelvin, Amperes, Hz, Coulombs, Watts, etc.

**Signal Averaging:** > 100 waveforms (2000 points each) per second; continuous mode, summation mode, or average of memory segments; up to 50,000 waveforms, FFT's.

**Spectrum Analysis:** 100 to 50,000 point FFT; Rectangular, Hamming, Hanning, Blackman Harris windows

**Basic Pulse Parameters:** Maximum, minimum, peak-to-peak voltage, rise time, fall time, pulse width, mean, standard deviation, rms, frequency, period, time to first cursor, time to last cursor, and delay from trigger to first edge

## Extended Pulse Parameters:

**Time Domain Parameters:** Time to first cursor, time to last cursor, number of points between, max., min., peak-to-peak, pulse amplitude, base, top, mean, standard dev., rms, median, mode, overshoot, undershoot, frequency, period, cycle, width, 10-90% rise time, 90-10% fall time, 20-80% rise time, 80-20% fall time, delay from trigger, time to max. pt., time to min. pt., time to first rise, time to first fall, area, etc

## Frequency Domain Parameters:

Amplitude, frequency, and phase of fundamental and harmonic components

**Parameter Statistics:** Trending and histogramming

## HARDCOPY

**Ports Supported:** RS-232C, Centronics, or internal floppy (screen dump in direct printer/plotter output format)

**Printers/ Plotters Supported:** IBM and Epson printers or compatibles, HP Laser Printers, HP 7400 and 7500 series, Philips PM 8155, Graphtec FP 5301 plotters, and compatibles

**Output Type:** Screen dump, waveform listing, program listing

**User Comment Field:** 40 characters

## PORTS

### GPIB (IEEE-488):

**Communication:** Talk/Listen or Talk Only

**Transfer Rate:** > 600 kbytes per second

**Address:** Rear panel switch selectable

### RS-232C:

**Communication:** Asynchronous, bidirectional

**Baud:** 110 to 19200

**Connector:** DB-9 male

### Centronics:

**Communication:** Output only

**Connector:** DB-25 female

**Remote Control (IEEE-488 and RS-232C only):** All commands can be sent in English-like format or in abbreviated format for increased throughput. Command format is based upon IEEE-488.2 Standard. Commands control all front-panel settable functions. Front panel operation can be locked out.

## PROGRAM MODE

Custom local decision making, custom operator menus, and special purpose testing require a user-written program.

**Development Environment:** MS-DOS based computer (> ver 2.0)

**Execution modes:** Fast (full speed) or Slow (to view each step of an executing program)

**Program storage/recall:** Hard or floppy disk

**Command Format:** Same as remote control commands

**Control Flow Statements:** IF/ELSE/ELSEIF, WHILE, FOR, BREAK, CALL/RETURN, etc

**User Menus:** Programmer labels, standard 7200 menu format, use of definable softkeys for user selections

**7200 Access:** All remote controllable features; oscilloscope status via "WAIT" (e.g. "WAIT HARDCOPY DONE"); external ports via "PRINT"

**Operators:** Variables with math and Boolean (+, -, /, X, OR, XOR, AND, MOD, etc.)

**Math Functions:** Trig, log, exponentiation, etc

## MECHANICAL/ ENVIRONMENTAL

**Power Required (with two 7242 Plug-ins installed):** 850 W max.; 90-125 VAC or 180-250 VAC, 47-63 Hz

**Dimensions:** 17" (435 mm) wide x 9.5" (240 mm) high x 24" (610 mm) deep

**7200 Weight:** 42 lbs (19 kg) without plug-ins

**7242 Weight:** 15 lbs (6.8 kg)

**Operating Temperature:** 5 to 40° C

**Operating Humidity:** Up to 80% r.h. non-condensing

**Operating Elevation:** To 7,000 ft. (2.2 km)

**Storage Temperature:** -40 to +75° C

## ORDERING INFORMATION

7200 Precision Digital Oscilloscope Mainframe with:

- Two year warranty with software updates
- Operator's and Programmer's Manuals
- Getting Started Guide

7242 Dual-Channel Digitizing Plug-in with:

- Two year warranty with software updates - (2) 7200-P10 probes
- Operator's and Programmer's Manuals

7200-P10 10:1 Oscilloscope Probe

7200-P21 500 Ω Oscilloscope Probe

7200-RKMT Rackmount kit

7200-SHIP Rugged shipping case

7200-OM Operator's Manual

7200-PM Remote Programmer's Manual

7200-SM Service and Calibration Manual

7242-OM Operator's Manual

7242-PM Remote Programmer's Manual

7242-SM Service and Calibration Manual

7200-SUP 1 year additional Software Update

DC/GPIB-2 2 meter GPIB cable



## LeCroy Digital Oscilloscopes Give You More

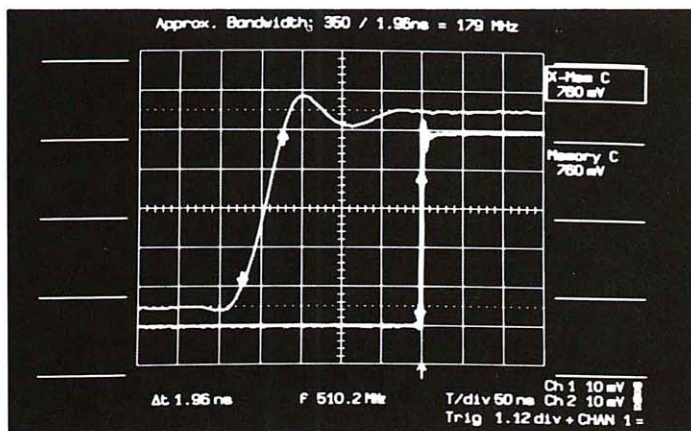

**Wide Bandwidth:** A fast step response is characterized using the 9420's pulse parameter capability. The instrument's 350 MHz bandwidth and excellent low-noise digitizing makes rise-time measurements in the nanosecond region with accuracy and precision.

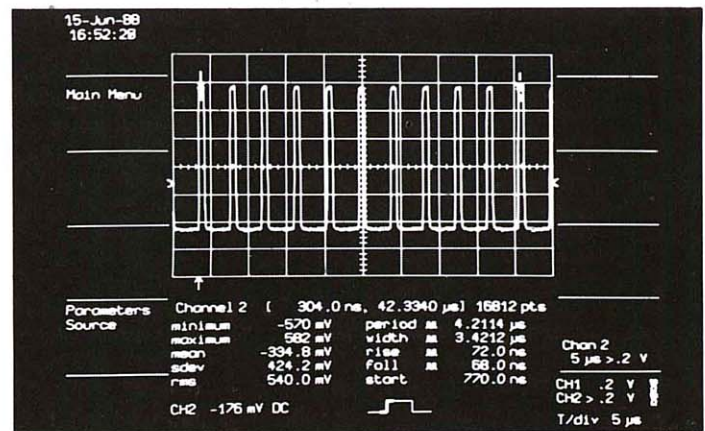

**Pulse Parameters:** Based on IEEE recommendations, the 9450 provides up to 10 waveform parameters in a fraction of a second. Parameters can be averaged over the total number of periods (max 100) found within the measurement zone. The start parameter allows propagation delay measurements over two channels.

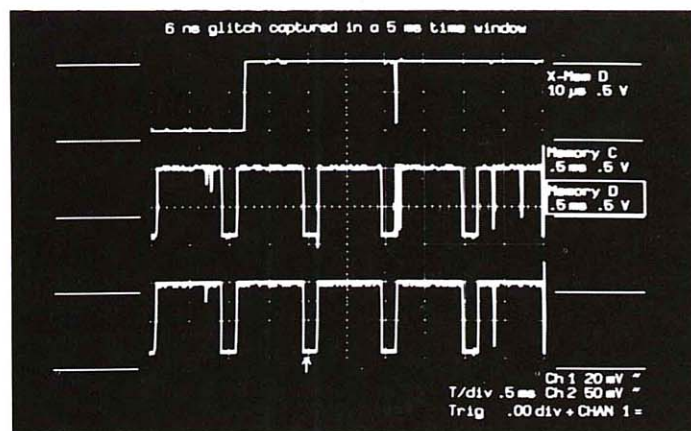

**Advanced Display:** The 9400A's "Min/Max" display capability ensures that any glitches will always be shown. Glitches as short as 10 nsec or 0.04% of the time base setting are captured with 100% probability in both normal and extrema modes. In this example, the glitches in the pulse train (lower trace) are captured in extrema mode (middle) and expanded (upper). The glitches are 6 nsec wide compared to the entire trace of 5 msec.

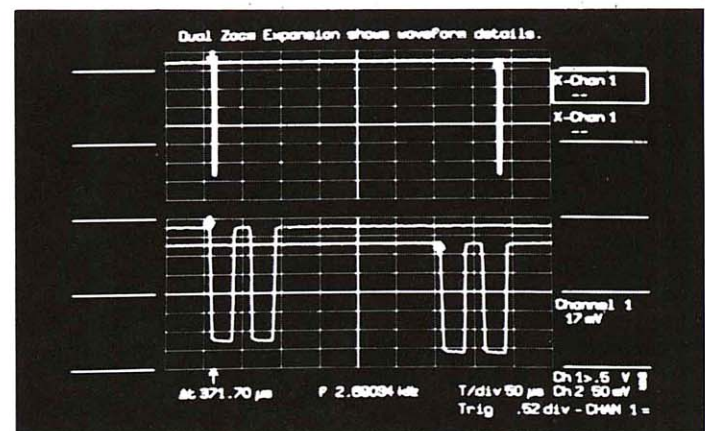

**Long Memories:** The 9400A's time cursors and long memories enable you to perform measurements with  $\pm 0.002\%$  accuracy and up to 40 psec resolution. Unique dual zoom expansion (lower traces) reveals that the glitches in the upper trace are actually double pulses. In this example, the time delay between the glitches is measured with 5-digit resolution.



# Portable and Benchtop Digital Oscilloscopes

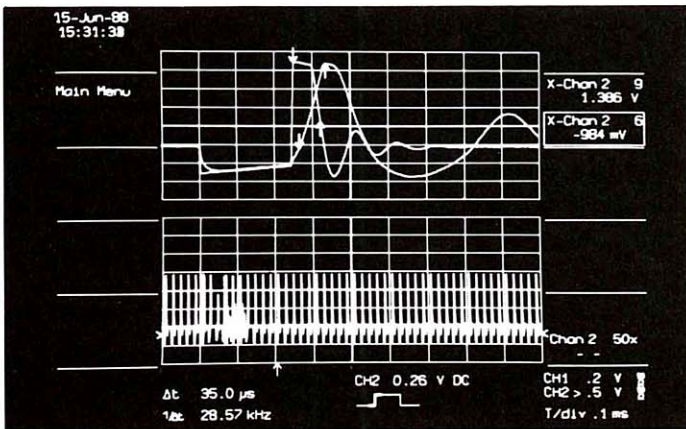

**Segmented Memories:** The memories of all 9400 series oscilloscopes can be segmented into as many as 200 partitions. Power switching events are logged over 50 segments (bottom). DUAL-ZOOM expansion (top) allows accurate comparison of events 6 and 9.

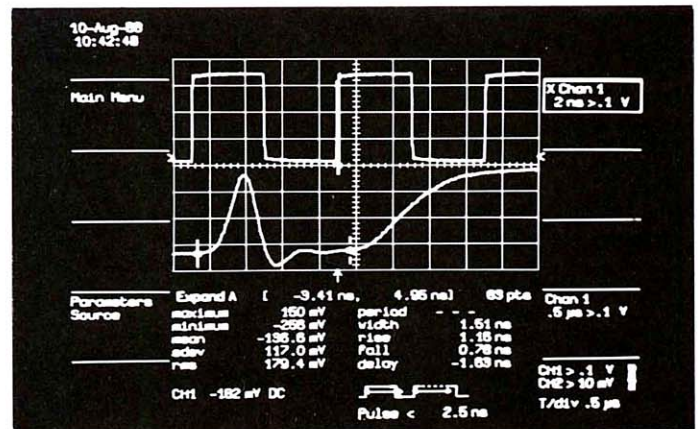

**Glitch Characterization:** Pulse parameters and FASTGLITCH trigger are outstanding complementary tools. A glitch 1.51 nsec wide is caught using the 9450's FASTGLITCH trigger mode. Pulse parameters are used to characterize this phenomenon after expansion (bottom).

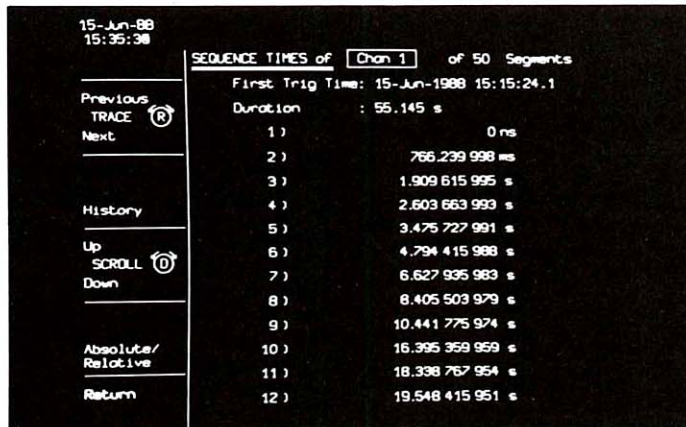

**Trigger Time Stamps:** Every trigger in the 9420, 9424 or 9450 is stamped with date and time. The events of the previous example (left) were recorded over a period of 55.145 sec. The first trigger (segment # 1) was logged at 15:15:24.1 hours. Subsequent triggers are measured with nanosecond resolution.

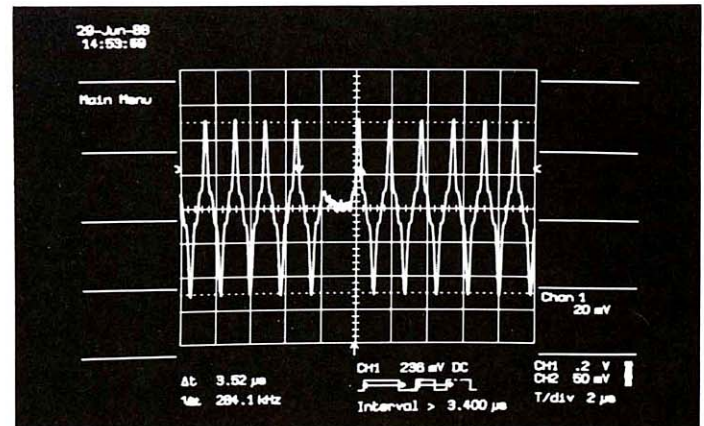

**Interval Trigger:** A missing bit in a disk read/write cycle is discovered using interval width trigger. The important trigger condition was the absence of a signal for a duration greater than 3.4 μsec. A dropout duration of 3.52 μsec is indicated by the cursors.



# Portable and Benchtop Digital Oscilloscopes

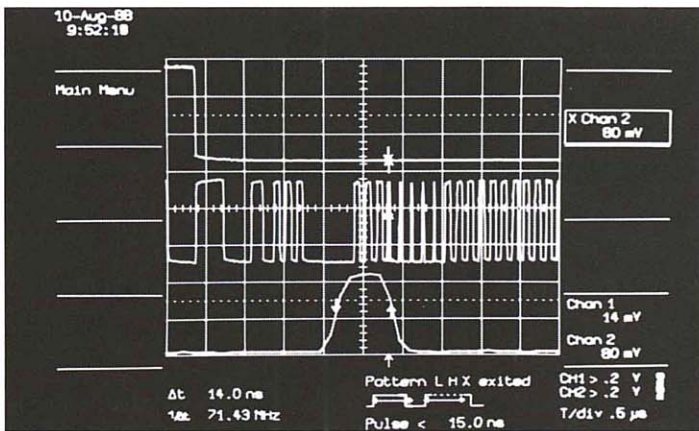

**Pattern Trigger (Exiting):** The 9450 triggers on the logic condition CH1 low (top), CH2 high (middle, expanded lower) and EXT don't care (not shown) with the further condition that the width of the pulse should be <15 nsec. The arrow under the grid indicates the trigger position.

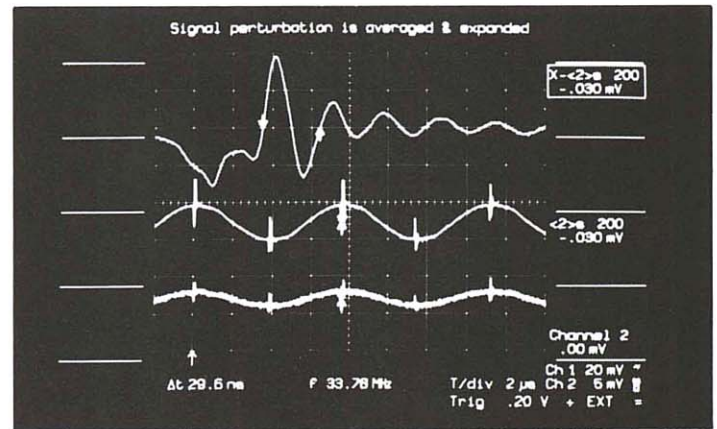

**Signal Averaging:** As well as improving the signal-to-noise ratio, averaging increases the sensitivity and vertical resolution (up to 12 bits after 256 averages). Above, a function generator signal (lower trace) with a small perturbation is averaged 200 times (middle), then expanded for further study (upper). The signal shows severe ringing at 33.78 MHz.

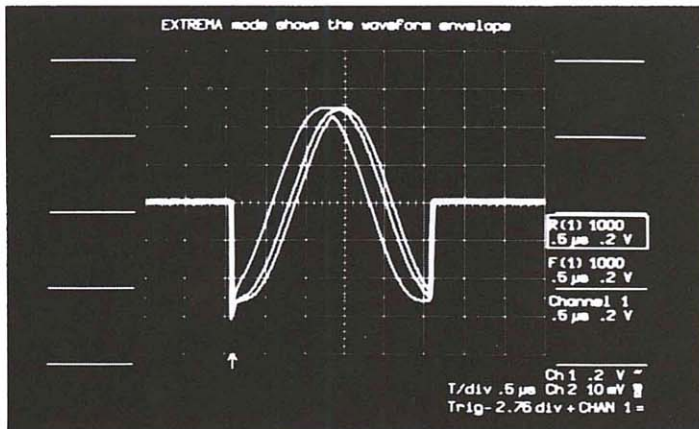

**Extrema Mode:** Using the 9400 series' unique extrema mode, time and amplitude drift, glitches, and spikes can be accurately recorded for a programmable number of sweeps. Above, a waveform from a gated signal generator (middle trace) shows serious gate synchronization problems. The upper and lower traces show the full envelope after 1000 sweeps.

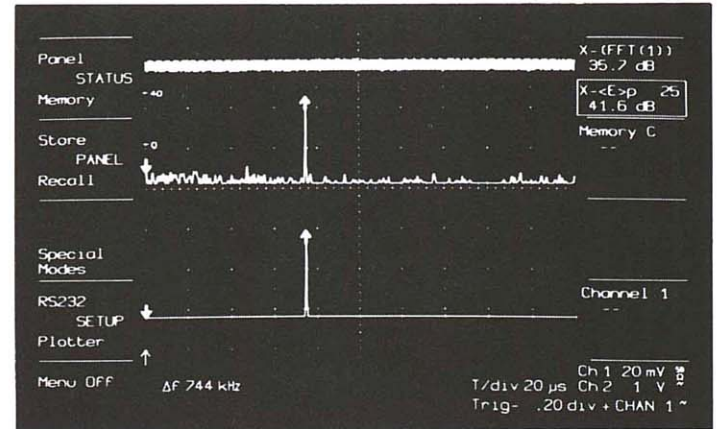

**Fast Fourier Transforms (FFT):** LeCroy oscilloscopes combine two instruments in one. Built-in FFT can perform spectrum analysis on time domain signals. Shown above, a small non-triggerable datacom signal is analyzed, and then averaged in the frequency domain. Its frequency spectrum indicates a principal component of 744 kHz. Averaging improves the signal-to-noise ratio by 5.9 dB.



## Digital Oscilloscope Accessories

- Cameras
- Soft Covers
- Transit Cases
- High Voltage Protector
- Digital Plotters
- Probes
- 'Scope Carts
- High Impedance Divider

### PROBES:

A variety of probes with attenuation factors from 1:1 to 100:1 are available.



### For 9400 Series Digital Oscilloscopes:

- P9010: 10:1 Probe
- P9010/2: 10:1 Probe with 2 meter cable
- P9020: 10:1 Probe, 300 MHz
- P9100: 100:1 Probe
- P9011: 10:1 / 1:1 Probe

### For 7200 Series Digital Oscilloscopes:

- 7200-P10: 10:1 Probe
- 7200-P21: 500 Ohm Probe



### PLOTTERS AND PRINTERS:

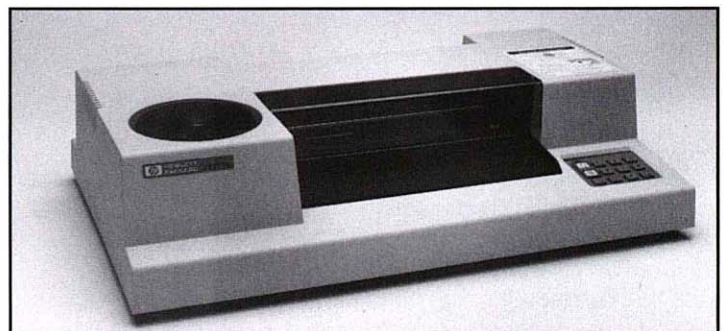

**DP9001:** For instant hard copies, LeCroy's digital oscilloscopes feature a screen dump facility which sends data directly to the DP9001 8-pen color digital plotter. Suitable for both 9400 and 7200 Series DSOs.



**DP9003:** For screen dumps of waveforms and setups, LeCroy offers an Epson FX850 Printer, available with serial interface, as the Model DP9003.

**DC/RS232:** RS-232C Cable for use with the DP9001 and DP9003.



---

# Portable and Benchtop Digital Oscilloscopes

---

## HIGH VOLTAGE PROTECTOR:

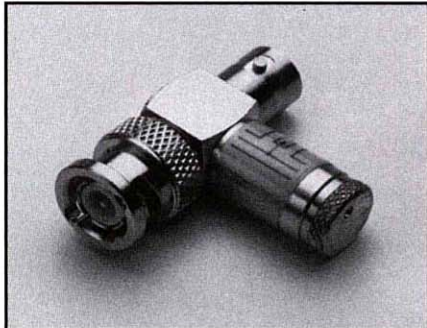

**SG9001:** If you are working with high voltage inputs, you may isolate your Digital Oscilloscope from excessive input voltage excursions that may damage the front end input stage. The Model SG9001 Surge Protector is recommended if you expect to be encountering input conditions that exceed 250 volts. It is a spark gap protection device, which adds miniscule capacitance to your signal, thus ensuring clean signal measurement. The SG9001 is placed in-line on the BNC input connector. Suitable for both 9400 and 7200 Series Scopes.

## IP-2: INSTAPULSER

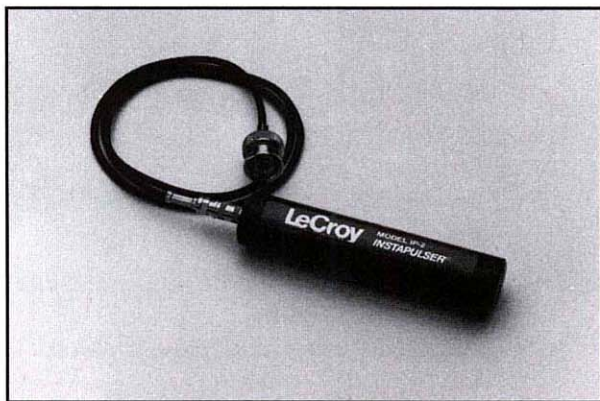

- 50 $\Omega$  matched output impedance
- 10 KC pulse rate
- 2 nsec risetime
- 1.2 V amplitude into 50 $\Omega$
- 5 nsec duration
- Direct-coupled
- No controls, always ON

## HIGH IMPEDANCE DIVIDER:



**D9010:** For high impedance applications that require more than the standard 2.5 volt/division sensitivity setting with the Models 9420/24/50, a 10:1 divider is now available. The D9010 is packaged so that it plugs directly onto the input BNC of the scope, and matches the bandwidth characteristics with almost any type of probe. The 9420/24/50 attenuation factors now include a setting for 10000:1, making it possible to use the D9010 and a suitable 1000:1 probe at sensitivities of over 10,000 volts/division.

## GPIB CARD FOR IBM COMPATIBLE PCs:

**IF/PC2:** The National Instruments GPIB/PC-2 Interface Card is available as LeCroy's Model IF/PC2 for one-vendor purchase requirements. It is used in a personal computer as a GPIB interface for compatibility with LeCroy digital oscilloscope and arbitrary function generators. (Note: The GPIB card required for LeCroy "digitizer" systems comes with FORTRAN software, and should be ordered under model number 69001C).

## CAMERA AND ADAPTER:

In the field, screen photographs can be taken with the CA9001 Camera (using Polaroid film) and hood system. For slides or higher resolution photography, a 35 mm camera can be used with the CA9002 adapter and hood system.

**CA9001:** Polaroid Camera and Hood

**CA9002:** 35mm Camera Adapter and Hood



---

# Portable and Benchtop Digital Oscilloscopes

---

## SCOPE CART:

Oscilloscopes can be easily transported around the laboratory on Oscilloscope Carts which roll on large locking castors.



**OC9001:** For 9400 Series or 7200 Series

## CARRYING CASE:



These soft cloth carry bags have an internal pouch for instruction manuals and accessories. Designed for customers who use their oscilloscope in several different locations, the carry bag also acts as a protective cover.

**TC9002:** For 9400 Series  
**7200-SOFT:** For 7200 Series

## TRANSIT CASES:



### For 9400 Series:

**TC9001:** The TC9001 is a heavy duty reinforced aluminum transit case. Light weight and measuring 30 x 50 x 60 cm, the case is ideal for transporting oscilloscopes by air, road or sea.

**TC9003:** The TC9003 is a transit case of similar composition to the TC9001 but has been structured to accommodate both the 9400A DSO and the IBM Laptop Computer, which is often used for the Mass Storage option (MS01).

### For 7200 Series:

**7200-SHIP:** Similar to the cases above, the 7200-SHIP shipping container allows ruggedized transport of your 7200 Series DSO mainframe.

## RACK MOUNTS:

**RM9400:** For 9400 Series  
**7200-RKMT:** For 7200 Series



# LeCroy Arbitrary Function Generators

---

### 9100 High Speed Dual Channel Arbitrary Function Generator



The 9100 is a dual channel AFG designed for uncompromised high speed performance. Dual channels for summed, phased, or differential outputs. Output arbitrary waveform to 100 MHz.

### 9109 High Speed Dual Channel Arbitrary Function Generator with Digital Outputs



The 9109 adds dual 8-bit digital outputs and longer waveform memory to the 9100. An excellent choice for high speed digital pattern generation or mixed mode analog/digital testing.

### 9101 High Speed Single Channel Arbitrary Function Generator



The 9101 is a high speed single channel AFG. This unit offers the high performance of the 9100 at a low cost. The 9101 is an excellent entry level AFG. Upgrades available to convert the 9101 to a 9100 or a 9109.

### 9112 High Resolution, High Accuracy Dual Channel Arbitrary Function Generator

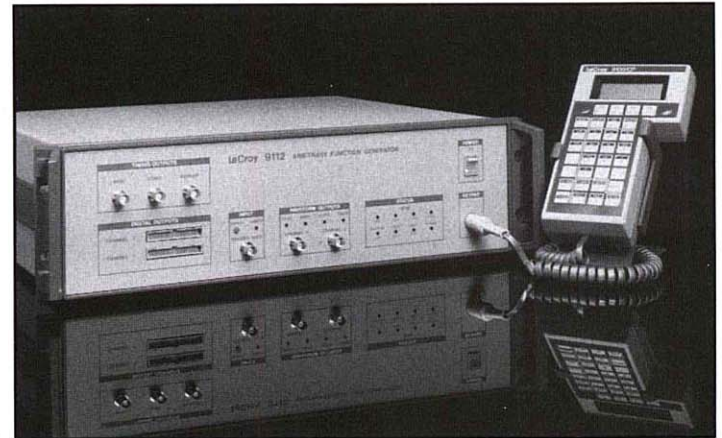

The 9112 is a dual channel 12-bit AFG optimized for signal fidelity and accuracy. Load compensation and self calibration maintain 0.3% DC accuracy. Dual 16-bit digital outputs permit independent mixed analog/digital testing.



## Arbitrary Function Generator Selection Guide

Model	9100	9101	9109	9112
<b>Architecture</b> Number of Channels Resolution (Bits) Maximum Sample Rate Waveform Length (Std.)	2 8 200 MHz 64 Kpts	1 8 200 MHz 64 Kpts	2 8 200 MHz 128 Kpts	2 12 50 MHz 64 Kpts
<b>Accuracy</b> Amplitude (DC) Accuracy Frequency Self Calibration Load Compensation	1% 5 ppm Yes No	1% 5 ppm Yes No	1% 5 ppm Yes No	0.3% 5 ppm Yes Yes
<b>Analog Output(s)</b> Full Scale Output (50 $\Omega$ ) Risetime Interchannel Sum External Sum Programmable Filters	10 Vpp <5 nsec Yes Yes Yes	10 Vpp <5 nsec No Yes Yes	10 Vpp <5 nsec Yes Yes Yes	10 Vpp <8 nsec No No No
<b>Harmonics and Noise</b> Harmonic Distortion <200 KHz <1 MHz <5 MHz Signal-to-Noise Ratio	-50 dBc -50 dBc -35 dBc >45 dB	-50 dBc -50 dBc -35 dBc >45 dB	-50 dBc -50 dBc -35 dBc >45 dB	-65 dBc -55 dBc -45 dBc >70 dB
<b>Digital Output(s)</b> Digital Word Output Max. Digital Word Size Logic Level	No N/A N/A	No N/A N/A	Yes Dual 8 bits TTL/ECL	Yes Dual 16 bits TTL
<b>Computer Interfaces</b> RS-232/GPIB	Yes	Yes	Yes	Yes
<b>Options Compatibility</b> Control Panel (9100/CP) EASYWAVE® (9100/SW) Memory Expansion	Yes Yes Yes	Yes Yes Yes	Yes Yes No	Yes Yes* No
<b>Page Number</b>	II - 4	II - 8	II - 10	II - 12

\*Requires Easywave Version 2.0 or higher



# About Arbitrary Function Generators

---

## What is an Arbitrary Function Generator?

The Arbitrary Function Generator (AFG) is a signal source that uses digital techniques to produce user specified custom analog waveforms. You might think of it as a digital oscilloscope operating in reverse. The shape, pattern, and harmonic content of the waveform to be generated are defined by a sequence of numeric values loaded into a high speed waveform memory. Each successive memory location contains a value proportional to the amplitude of the waveform point to be generated. A high precision programmable time base is used to clock the memory address counter which loads the next value to be output into a digital-to-analog converter (DAC). This produces an analog equivalent to the numeric waveform description. Like other digitally synthesized signal sources it is characterized by high accuracy, stability, repeatability, and ease of computer control. The distinctive benefit of an arbitrary function generator is the ability to produce structurally complex waveforms as well as standard sine, square, and triangle waves.

**Generates Multiple Periodic Waveforms:** Many users, like the telecommunications industry, need to generate waveforms which use multiple periodic waveforms with accurately controlled harmonic amplitude and phasing. These complex waveforms are readily generated using the AFG.

**Simulates Random or Infrequent Signals:** Another class of applications involves duplicating signals upon demand, that are the results of random or infrequent events. Electromagnetic pulse (EMP) susceptibility testing and power line transient testing are common examples. Such transient events can be specified by equation or captured using a digital oscilloscope or digitizer. Once the waveform file describing the transient waveform is generated, it can be used when and where needed.

**Precisely Controls Amplitude and Phase:** Other applications make use of the AFG's precise control of amplitude or phase. Radar, sonar, and radio navigation test signals are all phase sensitive. Arbitrary function generators with dual outputs are especially well suited for producing outputs with controllable phase differences. AFG's with synchronous digital outputs provide phased digital inputs directly to radar signal processing circuits at high, operational data rates. Magnetic peripherals like disk and tape drive testing require selective control of signal amplitude or timing a specific point within the waveform. Dual channel outputs can be added or subtracted to produce amplitude or timing variations at the desired points within the waveform for tolerance and margin testing.

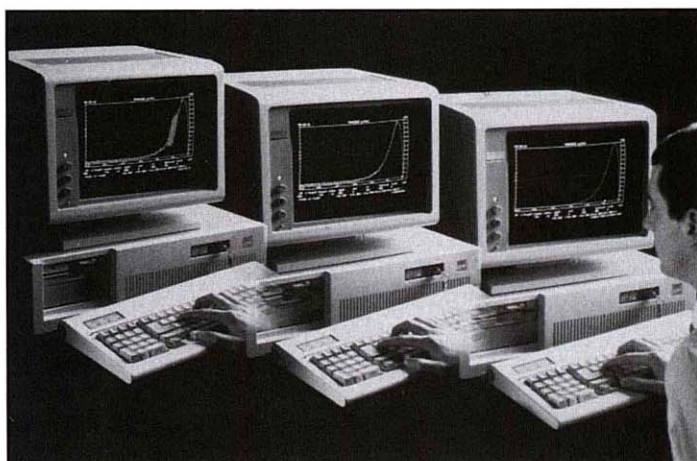



## Should You Be Using An AFG?

The examples cited are samples of a broader range of applications which would benefit from the use of an AFG as a test source. You should consider an AFG if your test signal requirements fall into any of the following categories:

- You're using "hot mockups", "golden reference" assemblies, or custom designed generators to supply real signals.
- You must test with signals that occur rarely, or unpredictably.
- You have to supply signals that originate in parts of a system that are unavailable or are hard to control.
- You have to supply multiple waveform types that would require many different signal sources.
- You need mixed analog and digital test signals.

## When Choosing an AFG, Be Sure to Consider the Following:

**Ease of Waveform Creation:** As the use of AFG's is a relatively new concept, it is extremely important to choose one that offers convenient user interaction. LeCroy's EASYWAVE waveform creation software (IBM PC compatible) is used to create and transfer waveforms to the AFG via GPIB. Its features include very easy waveform creation methods, file management, waveform transfer from LeCroy's digital scopes, and operation of the AFG.

**Sufficient and Non-volatile Waveform Storage Memory:** This type of memory is used to store a number of waveform files. Recalling stored waveforms is faster than recreating them from equations or externally downloading them when you want to change output waveforms. In LeCroy AFG's, non-volatile memory also stores setup files and macro-command sequence files, which are both used for quick, automated AFG operations.

**DC Accuracy:** DC accuracy is a measure of how precisely an AFG can provide the fundamental output voltage upon which all other smaller dynamic inaccuracies piggyback. It is important to focus on this attribute, and then analyze the overshoot, ringing, risetime, settling time, and harmonic distortions that can adversely affect the fidelity of your waveforms. LeCroy AFG's emphasize this specification, offering 1% and 0.3% DC accuracy on its AFG's.

**High Speed Clocking and Output Signal Conditioning:** All things being equal, the faster an AFG can output analog data points, the finer you can control the shape of the output waveform. However it is important to read the fine print when choosing raw speed as a criterion for output fidelity. Clock settability and output signal conditioning (i.e., amplifiers, attenuators, and filters) can be a vital factor in the ability to create waveforms for your application. LeCroy's AFG's boast 0.035% clock frequency resolution instead of binary countdowns. Output amplitude range, for each channel independently, is settable to 3 digit resolution with separate offset adjustments. This controllability, along with LeCroy's proven techniques for shifting waveform features, like edges and peaks, in increments as small as 500 ps, provide capabilities that are not apparent from a simple comparison of clock rate specifications.

**Dual Channel Operation:** In some AFG's, two independent channels operate from a common timebase, providing precise phase synchronization as well as simultaneous, dual-function operation. You can use the two channels to generate different but time-related signals, or you can sum the signals from both channels into one output.



# 9100 Dual Channel Arbitrary Function Generator

## Main Features

- 5 nsec/point Custom Waveforms
- Dual Channel Output
- 10 V p-p Waveform Outputs (50  $\Omega$ )
- < 5 nsec Risetime
- 350 Kpoint Non-Volatile Waveform Storage
- 64 Kpoint High Speed Waveform Memory
- Six Standard Waveforms
- GPIB Interface
- EASYWAVE® Waveform Creation Software (Optional)

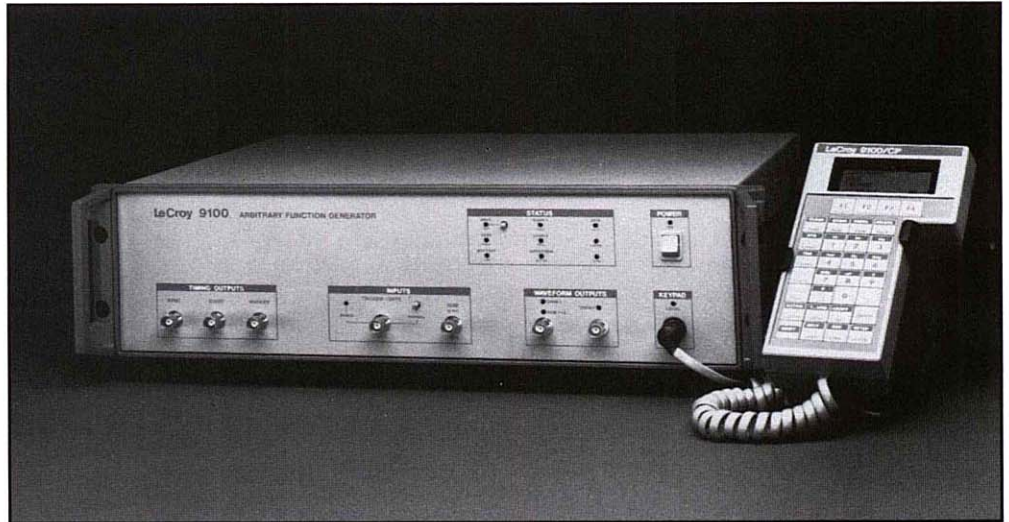

### GENERATES CUSTOM OR STANDARD WAVEFORMS

The LeCroy Model 9100 Arbitrary Function Generator (AFG) is a high performance ATE or benchtop instrument which can generate either standard or user defined, complex waveforms with unparalleled point-to-point time resolution. It is fully programmable via either GPIB or RS-232. Waveform generation and editing software is offered for PC-DOS compatible computers. Applications include: scientific research, medical instrumentation, disk drive testing, communication link testing, radar and sonar testing, ultra-sound testing and video testing.

Using LeCroy's optional EASYWAVE® software package with the 9100, you can easily and quickly create almost any conceivable "real world" waveform required for comprehensive and realistic testing of your circuits.

### High Speed Waveforms

Custom waveform outputs using digital generation techniques can now be created from amplitude points separated by as little as 5 nsec. Output circuitry in each channel is designed to provide matching performance. 300 MHz DACs coupled with wideband amplifiers yield fast risetimes and settling time. Built-in filters eliminate point-to-point steps to present smooth output shapes. Analog signals to 100 MHz can be created.

### Dual Channel Flexibility

In the Model 9100, two independent channels operate from a common time-base, providing synchronization capability as well as simultaneous, dual function operation. You can use the two channels to generate different but time-related signals, or you can sum the signals from both channels into one output. Various attributes of each signal can be changed quickly, on-line, without reloading new data bytes. Using the external summing input, you can add external influences, such as noise, voltage spikes, or other phenomena to your waveform.



## Versatile Memories for Waveform Generation and Non-Volatile Storage

The AFG uses a high speed waveform memory (64 Kpoints) to generate waveforms. This memory can be downloaded with a variety of different waveform files or segments from the separate 350 Kbyte non-volatile memory. Waveform elements can be repeated and linked together to effectively increase the composite waveform length to billions of points. Each custom waveform can be repeated up to 65,535 times.

## Standard and Arbitrary Functions

In addition to its primary function as an Arbitrary Function Generator, the 9100 also provides both standard function generation and pulse generation capabilities. Sine, square, triangular, ramp, pulse and DC-waveform functions are built-in standards. Function selection and parameter manipulation can be implemented from the control panel or via the GPIB or RS-232-C interface.

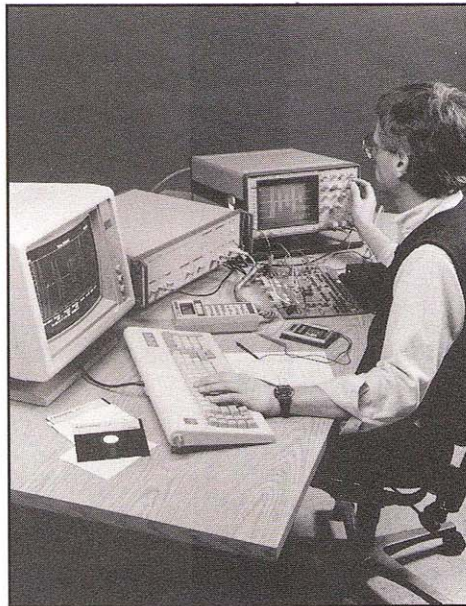

*Custom waveforms can be captured by a digital scope or digitizer, and then edited and regenerated with the 9100 AFG. Or they can be created from scratch from simple elements or equations with our user-friendly EASYWAVE software.*

## Flexible Operation and Trigger Modes

Waveforms can be output as a single shot, as a triggered burst of up to 64 K cycles, as an auto-triggered recurrent waveform with programmed delays between cycles, as a continuous waveform, or gated under control of an external signal. Triggering can be manual, bus operated, or external, with selectable slope, polarity, level, and delay. Timemark, sync'd, waveform start, and clock outputs provide flexible timing reference for synchronized operation.

## Optional Hand Held Control Panel

An optional hand held control panel allows test technicians full access to stored waveforms and permits flexible manipulation of these waveforms without the use of a computer.



## 9100 Specifications

### WAVEFORM OUTPUTS

**Channels:** 2.

**D.C. Accuracy:** 1.0% or 20 mV (whichever is greater).

**Resolution:** 8 bits (256 levels).

Single or dual channel - 8 bits;

**Channels summed** - 9 or more bits, depending on pulse shape, filtering, offset requirements.

**Total Harmonic Distortion:** <-50 dBc for output frequency of 1 MHz or less. <- 35 dBc @ 10 MHz, Typically <- 38 dBc @ 10 MHz for output levels < 5V p-p.

**Spurious and non-harmonic distortion:**

Above 1 MHz  $\leq$  60 dBc. 1 MHz and below:  $\leq$  65 dBc.

**Intermodulation distortion:** Two tone intermodulation (ch1: 10 MHz, 1 V p-p; ch 2: 10.25 MHz, 1 V p-p; summed mode) typical - 58 dBc 3rd order; - 70 dBc 5th order.

**Signal to Noise Ratio:**

Full Scale Amplitude	S/N
75 mV or greater	$\geq$ 45 dB
30 mV	40 dB
5 mV	25 dB

S/N specified at 0 V offset, sum mode off.

**Maximum Output Voltage:** 10 V p-p ( $\pm$  5 V) into 50  $\Omega$ , 20 V p-p into high impedance.

**Minimum Output Voltage:** 5 mV p-p into 50  $\Omega$ .

**Risetime:** < 5 nsec, 10% to 90% (no filter).

**Overshoot and Ringing:** 5% of p-p amplitude, maximum; 3% of p-p amplitude, typical.

**Settling Time:** < 10 nsec to 3% for full scale transition, including risetime (filters off).

**Offset:** Individually programmable for each channel.

**Offset Resolution:** < 6 mV steps.

**Offset Accuracy:** Same as D.C. accuracy.

**Maximum Offset Voltage:**

External Load	Max. Offset V
50 $\Omega$	$\pm$ 5 V
Open Circuit	$\pm$ 10 V

**Output Smoothing:** Built-in filters with programmable cutoff frequencies: bypassed, 1, 3, 10, 30, 100 MHz; 18 dB/octave (Bessel)

**Crosstalk between channels:** < 1%

**Ch 1 to Ch 2 Phase Accuracy:**

**Internal Summing:**  $\pm$  .5 nsec.

**Dual Outputs:**  $\pm$  1 nsec

### STANDARD FUNCTIONS (WAVEFORMS)

**Sinewave:**

**Frequency Range** - 0.01 Hz to 100 MHz

**Frequency Resolution** - 0.035%

**Squarewave:**

**Frequency Range** - 0.01 Hz to 25 MHz

**Frequency Resolution** - 0.035%.

**Triangle:**

**Frequency Range** - 0.01 Hz to 25 MHz.

**Frequency Resolution** - 0.035%.

**Linearity** -  $\pm$  1%.

**Pulse (single channel only):**

**Period** - 40 nsec to 10 sec.

**Width** - Variable, 5 nsec to 10 sec (not to exceed period).

**Orientation** - Selectable, positive or negative going.

**Ramp**

**Period** - 40 nsec to 100 sec.

**Resolution** - 0.035%.

**Linearity** -  $\pm$  1%

**Orientation** - Selectable, positive or negative going.

**DC:** Generates a D.C. level, the value of which is the offset level.

**Accuracy:** The greater of 1% or 20 mV.

### TIME BASE (CLOCK RATE)

**Range:** 5 nsec to 20 sec per point.

**Resolution:** 0.035%.

**Accuracy:**  $\leq$  5.0 ppm, at achievable set points, @ 23° C, 115 VAC/60 Hz, after 30 minute warmup.

**Stability:** < 0.5 ppm /° C.

### TRIGGER MODES

**Continuous:** The generator runs continuously at the selected frequency.

**Recurrent:** The waveform is cycled with a programmable delay of up to 1 million points (1/2 million in dual channel) between cycles. Number of waveforms per cycle is programmable up to 65,535.

**Single:** Upon receipt of a trigger, the selected waveform is generated only once. The start of the waveform can be delayed from the trigger point by up to 1 million points (1/2 million in dual channel).

**Burst:** Upon receipt of a trigger, the selected waveform is generated the number of times set into the burst counter, up to 65,535. The start of the burst can be delayed up to 1 million points (1/2 million in dual channel).

**Gated** (uses the trigger threshold): Uses a triggered start, and stops at the completion of the current waveform cycle after the gate closes.

**External Trigger Threshold:**

**Slope** - + or -

**Range** -  $\pm$  2.5 V

**Resolution** - 20 mV (8 bits)

**Source:**

**Manual** - Front panel button

**External** - External trigger applied via a front panel BNC

**Bus** - Trigger from GPIB or RS-232

**Control Panel** - Trigger Key

**Arm Source:**

**Auto** - Automatically rearms itself.

**Bus** - Rearmed from the GPIB, RS-232 or the Control Panel.

Trigger sources and arm sources may be individually enabled or disabled. Internal triggering is automatically selected in continuous or recurrent trigger modes.

**Delay:** Variable, from four to one million points (2 to 1/2 million in dual channel).



## WAVEFORM MEMORY

### Fast Memory Length:

Single Channel - 64 Kpoints.

Dual Channel - 32 Kpoints each channel.

### Storage Memory Length (RAM Disk):

> 350 Kpoints for waveforms, setup and sequence files.

### RAM Disk to Fast Memory Load Rate:

250 msec + 0.6  $\mu$ sec/byte.

**Battery Back-up:**  $\geq$  3 years, non-rechargeable lithium.

**Minimum Waveform Length:** Non-linked waveform segment, no looping - 8 points (4 points per channel in dual channel mode).

Linked waveforms Single channel operation - 72 points. Dual channel operation - 36 points/channel.

**Waveform Length Resolution:** Single channel operation - 8 point blocks.

Dual channel operation - 4 point blocks.

**Waveform Loop Counter:** One counter per linked waveform

**Maximum Repetitions:** 4,095

## OUTPUTS

### Front Panel:

**Waveform Output -** Output impedance, 50  $\Omega$ . Protected against applied voltages to  $\pm$  40 V. If an externally applied overvoltage condition is detected, the output relay is opened, the LED for that channel is flashed and, if enabled, a SRQ is generated on the GPIB.

**All Timing Outputs -** Output impedance, 50  $\Omega$  Source 1.5 Volts peak into 50  $\Omega$ . Approximately 75 nsec duration.

Time Marker Output: Settable from four up to one million clock cycles, referenced to the trigger point.

Sync Trigger Output: Occurs at the next sample clock edge after receiving an Ext. Trigger.

Waveform Start Output: Occurs at the start of the waveform.

### Rear Panel:

**Clock Outputs -** 0 to - 0.8 V into 50  $\Omega$ . Approx. a squarewave. Present in all modes including Ext. Clock.

## INPUTS

**Protection:** The maximum input voltage level for all inputs should not exceed 5 V.

### Front Panel:

**External Gate/Trigger Input -** 50  $\Omega$ .

**Sum Input -** Impedance: 50  $\Omega$ .

Gain: X 1,  $\pm$  5% for > 350 mV full scale output ranges Bandwidth: > 80 MHz at 3 dB.

**Hand Held Keypad (Control Panel) Input:** A DIN connector is provided for attaching the hand held control panel and display.

### Rear Panel:

**External Clock Input -** When this input is selected, the internal clock is de-selected and the waveform is generated using the external clock.

Impedance: 50  $\Omega$ .

Threshold: Variable  $\pm$  2.5 V, 8 bits resolution

**External Reference Input -** A signal on this input causes the internal clock to phase lock to it. It requires a 4 MHz square wave with 500 mV to 5 V p-p amplitude into 50  $\Omega$ , AC coupled.

### Front Panel Indicators and Controls:

**Power -** ON/OFF

**Manual Trigger Button**

**Manual Self Test Button**

**Hand Held Control Panel (optional)**

### Indicators:

**Power on LED -** ON when power is applied to the instrument.

**Trigger Armed LED -** ON when awaiting a trigger signal.

### Waveform Output LED's-

Chan 1: ON when Channel 1 is turned on.

Chan 1 & 2: ON when channel 1 is being summed with channel 2.

Chan 2: ON when channel 2 is turned on.

Waveform Active LED: ON when a waveform is being clocked out of the fast memory to one or both waveform outputs or if the unit is armed and waiting for a trigger.

## GPIB:

LED for Talk, Listen, SRQ, Remote, Local, Self Test, Test Fault, Battery Low, Chan 1, Invert, and Chan 2 Invert.

### Rear Panel Connectors and Switches

**Connectors:** GPIB: IEEE 488, 1978 compatible. RS-232 Port : DB 25 S.

**Switches:** GPIB Address Switch, RS 232 Port Configuration Switch. Line voltage selector and fuses.

### Waveform Creation and Editing

LeCroy's EASYWAVE<sup>®</sup> software package is available for PC-DOS compatible computers\*. See EASYWAVE Technical Data Sheet.

## INSTRUMENT CONTROL

**PC-DOS Compatibles:** The same software package used for waveform editing also can be used for controlling the 9100.

**Local Control Panel:** Once the waveforms have been loaded to RAM Disk, an optional, detachable control panel with a four line LCD display may be used for controlling the 9100.

**Other GPIB or RS-232 Compatible Controllers:** Other computers or terminals may be used to control the instrument using the remote commands.

## GENERAL

**GPIB Interface Functions:** IEEE 488-1978 compatible. SH1, AH1, T5, TE0, L3, LE0, SR1, RL1, PP0, DC1, DT1, C0.

**GPIB DMA Rates:** Typically  $\geq$  200 KB/sec.

**Data Formats -** #I Arbitrary length ASCII, #L ASCII HEX "00" to "FF" (double the length of internally stored binary data files).

**RS-232C:** Implemented as Data Communications Equipment (DCE).

**Baud Rates:** 300, 1200, 2400, 4800, and 9600.

**Bits -** Data: 7 or 8; Stop: 1 or 2.

**Parity -** None, Even, or Odd.

**Protocol -** Full Duplex, Xon/Xoff (DC1/DC3) handshake.

**Commands -** Full Conversational same as GPIB plus: RS\_SRQ, Define character equivalent to SRQ in GPIB. Default is "Bell", ESC commands ECHO on/off Trig remote/local.

**Temperature Range:** 15 $^{\circ}$  C. to 35 $^{\circ}$  C., full specification; 0 $^{\circ}$  C. to 40 $^{\circ}$  C., operating.

**Humidity:** 40 $^{\circ}$  C., 10% to 95% relative, non-condensing.

**Power:** 115/220  $\pm$  20% VAC, 47-63 Hz. approx 147 watts.

**Size:** 5-1/4" H X 19" W X 15" D. Weight: 26 lbs. (approximately).

## OPTIONS and ACCESSORIES

9100/CP	Hand Held Control Panel
9100/EC	6' Extension Cable
9100/EM	Extended Memory (128 K total)
9100/MM	Multiple Memory Extension 512 Kbyte total waveform memory, 1 Mbyte non-volatile memory (Available 3/90)
9100/RT	Realtime waveform segment addressing (Available 3/90)
9100/OM	Extra Operator's Manual
9100/SM	Service Manual
9100/SW	EASYWAVE Software
9100GPIB2	GPIB interface card and soft ware National Instruments PCII Card and GPIB-PC Software
DC/GPIB-2	GPIB Cable, 2 meters



# 9101 Single Channel Arbitrary Function Generator

## Main Features

- 200 Mpoint/sec Custom Waveforms
- 10 V p-p (50  $\Omega$ ) Outputs
- < 5 nsec Risetime
- 350 Kpoint Non-volatile Storage
- Standard Function Waveforms Pulse Generator
- GPIB/RS-232 Interface
- EASYWAVE® Waveform Creation Software (Optional)



## General

The LeCroy Model 9101 Arbitrary Function Generator (AFG) is a high performance ATE or benchtop instrument which can generate either standard or user defined, complex waveforms with unparalleled point-to-point time resolution. It is fully programmable via either GPIB or RS-232. Waveform generation and editing software is offered for PC-DOS compatible computers.

### GENERATES CUSTOM OR STANDARD WAVEFORMS

The LeCroy 9101 Arbitrary Function Generator is a highly versatile signal source which can generate custom, pulse or standard waveforms. The 9101 has a 200 Mpoint/sec single channel output which makes it possible to accurately produce "real world" waveforms that a standard function generator could not provide. Almost any conceivable waveform can be constructed. Altogether, the LeCroy 9101 provides a custom waveform generator, a standard

function generator and a pulse generator. Six standard waveforms are built in and can be output, without the need for the computer, using the 9100/CP hand held control panel.

### MEMORIES

The fast waveform memory of the generator is 64 Kpoints long and when combined with the linking and looping (repeating) features equivalently provides billions of points of operating memory. The 9101 AFG has 350 Kpoint battery backed-up non-volatile storage memory. The storage memory allows custom waveforms to be stored for later output under the control of the detachable control panel or computer.

### SOFTWARE

LeCroy's EASYWAVE® software makes custom waveform creation fast and easy. This optional software package simplifies waveform data entry using a library of software-based simple waveform

elements, mathematical equations, or spreadsheet-like point array editing. EASYWAVE uses a cut and paste approach to waveform editing, wave-shapes can be composed by linking them together, repeating them or rescaling them either vertically or horizontally. One of the most powerful capabilities in EASYWAVE is the ability to acquire waveform data from any LeCroy digital oscilloscope or waveform digitizer. Now, this real-life data can be modified or modulated even further using any of the extensive editing capabilities within EASYWAVE, then regenerated. EASYWAVE also provides file management, operating control and system configuration features.

### APPLICATIONS

Applications include: scientific research, medical instrumentation, disk drive testing, communication link testing, radar and sonar testing, ultra-sound testing and video testing.



## 9101 Specifications

### WAVEFORM OUTPUTS

**Channels:** 1.

**D.C. Accuracy:** 1.0% or 20 mV (whichever is greater).

**Resolution:** 8 bits (256 levels).

**Total Harmonic Distortion:** <- 50 dBc for output frequency of 1 MHz or less.  
<- 35 dBc @ 10 MHz, typically <- 38 dBc @ 10 MHz for output levels < 5V p-p.

**Spurious and non-harmonic distortion:**  
<- 60 dBc.

**Signal to Noise Ratio:**

Full Scale Amplitude	S/N
75 mV or greater	≥ 45 dB
30 mV	40 dB
5 mV	25 dB

S/N specified at 0 V offset.

**Maximum Output Voltage:** 10 V p-p ( $\pm 5$  V) into 50  $\Omega$ , 20 V p-p into high impedance.

**Minimum Output Voltage:** 5 mV p-p into 50  $\Omega$ .

**Risetime:** < 5 nsec, 10% to 90% (no filter).

**Overshoot and Ringing:** 5% of p-p amplitude, maximum 3% of p-p amplitude, typical.

**Settling Time:** < 10 nsec to 3% for full scale transition, including risetime (filters off).

### STANDARD FUNCTIONS (WAVEFORMS)

**Sinewave:**

**Frequency Range** - 0.01 Hz to 25 MHz

**Frequency Resolution** - 0.035%

**Squarewave:**

**Frequency Range** - 0.01 Hz to 100 MHz

**Frequency Resolution** - 0.035%.

**Triangle:**

**Frequency Range** - 0.01 Hz to 25 MHz.

**Frequency Resolution** - 0.035%.

**Linearity** -  $\pm 1\%$ .

**Pulse**

**Period** - 40 nsec to 10 sec.

**Width** - Variable, 5 nsec to 10 sec (not to exceed period).

**Orientation** - Selectable, positive or negative going.

**Ramp**

**Period** - 40 nsec to 100 sec.

**Resolution** - 0.035%.

**Linearity** -  $\pm 1\%$

**Orientation** - Selectable, positive or negative going.

**DC:** Generates a D.C. level, the value of which is the offset level. Accuracy: The greater of 1% or 20 mV.

### TIME BASE (CLOCK RATE)

**Range:** 5 nsec to 10 sec per point.

**Resolution:** 0.035%.

**Accuracy:**  $\leq 5$  ppm, at achievable set points, @ 23° C, 115 VAC/60 Hz, after 30 minute warmup.

**Stability:** < 0.5 ppm /°C.

### TRIGGER

**Modes:**

**Continuous** - The generator runs continuously at the selected frequency.

**Recurrent** - The waveform is cycled with a programmable delay of up to 1 million points between cycles. Number of waveforms per cycle is programmable up to 65,535.

**Single** - Upon receipt of a trigger, the selected waveform is generated only once. The start of the waveform can be delayed from the trigger point by up to 1 million points.

**Burst** - Upon receipt of a trigger, the selected waveform is generated the number of times set into the burst counter, up to 65,535. The start of the burst can be delayed up to 1 million points.

**Gated** (uses the trigger threshold) - Uses a triggered start, and stops at the completion of the current waveform cycle after the gate closes.

### WAVEFORM MEMORY

**Waveform Memory Length:** 64 Kpoints.

### GENERAL

**GPIB Interface Functions:** IEEE 488-1978 compatible. SH1, AH1, T5, TE0, L3, LE0, SR1, RL1, PP0, DC1, DT1, C0 .

**GPIB DMA Rates:** Typically  $\geq 200$  Kbytes/sec.

**Data Formats** - #I Arbitrary length ASCII, #L ASCII HEX "00" to "FF" (double the length of internally stored binary data files).

**RS-232C:** Implemented as Data Communications Equipment (DCE).

**Baud Rates** - 300, 1200, 2400, 4800, and 9600.

**Data Bits** - 7 or 8.

**Stop Bits** - 1 or 2.

**Parity** - None, Even, or Odd.

**Protocol** - Full Duplex, Xon/Xoff (DC1/DC3) handshake.

**Commands** - Full Conversational same as GPIB plus: RS\_SRQ, Define character equivalent to SRQ in GPIB. Default is "Bell", ESC commands ECHO on/off Trig remote/local.

**Temperature Range:** 15° C. to 35° C., full specification; 0° C. to 40° C., operating.

**NOTE:** The technical specifications of the 9101 are identical to the 9100 with the exception of references to the channel 2 output and related specifications such as summed mode operation. Please consult the 9100 technical data sheet for additional common specifications.



# 9109 Arbitrary Function Generator With Digital Outputs

## Main Features

- 200 Mpoint/sec Custom or Standard Waveforms
- Dual Channel
- 10 V p-p Analog (50  $\Omega$ ) Outputs
- < 5 nsec Risetime
- Generates Mixed Analog/Digital Waveforms
- 350 Kpoint Non-volatile Storage
- 128 Kpoint Waveform Memory
- Dual 8-Bit Digital Outputs

## General Description

The Model 9109 is a high speed Arbitrary Function Generator which can generate custom or standard waveforms and equivalent digital data patterns. Its high speed (up to 200 Megapoints/sec) makes it possible to produce "real world" custom waveforms for testing digital filters, RADAR and SONAR signal processing systems, disk drives, A/D-D/A converters, video systems, and data communications systems. It is fully programmable via either GPIB or RS-232. Waveform generation and editing software is offered for PC-DOS compatible computers.

### DUAL CHANNEL OPERATION

Dual channel operation, with independent amplitude, offset, and phase delay, provides the ability to simultaneously generate two different signals. Also, generating the same signal on both channels and inverting one results in differential output signals. The excellent phase match between channels permits the generation of precise, phase related signals for use in such applications as



testing logic set up times or synchro resolvers. It is especially suited for mixed signal automated testing for products such as digital filters, A/D converters, D/A converters, video systems, and data communications circuits.

### MEMORIES

128 Kpoints of waveform memory, combined with waveform linking and repeating, provides the equivalent of billions of points of memory. Almost any conceivable waveform can be constructed. Additionally, there is a RAM disk which provides over 350 Kpoints of non-volatile waveform or digital pattern storage. Waveforms stored here can be loaded to waveform memory and output under the control of the detachable hand held control panel, computer, or GPIB controller.

### INTERNAL CHANNEL SUMMING

Internally summing the two channels together makes it possible to combine two waveforms and control the amplitude of one portion of the resultant composite waveform independently of the rest of it.

This also provides expanded dynamic range because one portion of the waveform can be attenuated relative to the rest without losing resolution (bits). Also, by setting the amplitude range of each channel to half the desired total amplitude and summing, a resolution of 9 bits can be achieved.

### WAVEFORM CREATION SOFTWARE

LeCroy's optional EASYWAVE<sup>®</sup> software simplifies creation of custom waveforms or digital data patterns. Waveforms can be created directly from the mathematical equation which describes the waveform. Or, it may be easier to simply select the needed shapes from EASYWAVE's library of simple waveform elements, link them together, and then stretch them to desired amplitudes and time durations. A spreadsheet-like array editor is used for point by point waveform or pattern entry in decimal or hexadecimal form. Waveforms may also be captured using any of LeCroy's digital oscilloscopes, digitizers, or transient recorders, and transferred to the 9109.



## 9109 Specifications

### WAVEFORM OUTPUTS

**Channels:** 2.

**D.C. Accuracy:** 1.0% or 20 mV (whichever is greater).

**Resolution:** 8 bits (256 levels).

**Total Harmonic Distortion:**  $\leq$  50 dBc for output frequency of 1 MHz or less.  $\leq$  35 dBc @ 10 MHz, typically  $\leq$  38 dBc @ 10 MHz for output levels  $<$  5 V p-p.

**Spurious and non-harmonic distortion:**  $\leq$  60 dBc.

**Signal to Noise Ratio:**

Full Scale Amplitude	S/N
75 mV or greater	$\geq$ 45 dB
30 mV	40 dB
5 mV	25 dB

S/N specified at 0 V offset, sum mode off.

**Maximum Output Voltage:** 10 V p-p ( $\pm$  5 V) into 50  $\Omega$ , 20 V p-p into high impedance.

**Minimum Output Voltage:** 5 mV p-p into 50  $\Omega$ .

**Risetime:**  $<$  5 nsec, 10% to 90% (no filter).

**Overshoot and Ringing:** 5% of p-p amplitude, maximum 3% of p-p amplitude, typical.

**Settling Time:**  $<$  10 nsec to 3% for full scale transition, including risetime (filters off).

### STANDARD FUNCTIONS (WAVEFORMS)

**Sinewave:**

**Frequency Range** - 0.01 Hz to 25 MHz

**Frequency Resolution** - 0.035%

**Squarewave:**

**Frequency Range** - 0.01 Hz to 25 MHz

**Frequency Resolution** - 0.035%.

**Triangle:**

**Frequency Range** - 0.01 Hz to 25 MHz.

**Frequency Resolution** - 0.035%.

**Linearity** -  $\pm$  1%.

**Pulse (single channel only):**

**Period** - 40 nsec to 10 sec.

**Width** - Variable, 5 nsec to 10 sec (not to exceed period).

**Orientation** - Selectable, positive or negative going.

**Ramp:**

**Period** - 40 nsec to 100 sec.

**Resolution** - 0.035%.

**Linearity** -  $\pm$  1%

**Orientation** - Selectable, positive or negative going.

**DC:** Generates a D.C. level, the value of which is the offset level. Accuracy: The greater of 1% or 20 mV.

### TIME BASE (CLOCK RATE)

**Range:** 5 nsec to 20 sec per point.

**Resolution:** 0.035%.

**Accuracy:**  $\leq$  5 ppm, at achievable set points, @ 23° C, 115 VAC/60 Hz, after 30 minute warmup.

**Stability:**  $<$  0.5 ppm/° C.

### TRIGGER

**Modes:**

**Continuous** - The generator runs continuously at the selected frequency.

**Recurrent** - The waveform is cycled with a programmable delay of up to 1 million points (1/2 million in dual channel) between cycles. Number of waveforms per cycle is programmable up to 65,535.

**Single** - Upon receipt of a trigger, the selected waveform is generated only once. The start of the waveform can be delayed from the trigger point by up to 1 million points (1/2 million in dual channel).

**Burst** - Upon receipt of a trigger, the selected waveform is generated the number of times set into the burst counter, up to 65,535. The start of the burst can be delayed up to 1 million points (1/2 million in dual channel).

**Gated** (uses the trigger threshold) - Uses a triggered start, and stops at the completion of the current waveform cycle after the gate closes.

### WAVEFORM MEMORY

**Waveform Memory Length:**

**Single Channel** - 128 Kpoints.

**Dual Channel** - 64 Kpoints/channel.

### DIGITAL OUTPUTS

**Output Channels:** Two channels with channel 1 data corresponding to the channel 1 analog output. Channel 2 digital data corresponds to the channel 2 analog output. Digital data is normalized so that a data value of 255 ( $FF_n$ ) corresponds to maximum analog amplitude and a data value of 0 ( $00_n$ ) corresponds to the minimum analog output.

**Digital Outputs:** Dual 8-bit outputs independently configurable as TTL or ECL.

Mode	Digital Output Width	Max. Clock Rate	Pattern Depth
Single channel	8 bits	200 MHz	128 K
Dual Channel	16 bits	100 MHz	64 K

**Digital Outputs per Channel:** TTL mode; 8 data lines, differential clock output, 10 grounds, ECL mode; 8 differential data lines, differential clock output, 2 grounds.

**Digital Output Mode Selection:** Each channel individually configurable as TTL or ECL output by internal jumper selection. Configuration indicated by LED's on front panel.

**Maximum Data Output Rates:** Identical to 9109 clock rate; single channel (channel 1 only): 200 Megabytes/second (5 nsec/byte). Dual channel (channel 1 and channel 2): 100 Mbytes/sec (10 nsec/byte).

**Data Timing:** Digital data outputs precede analog data outputs by 1 clock period.

**Maximum Data Clock Rates:** TTL Mode - typical  $>$  80 MHz.

ECL mode - typically  $>$  200 MHz.

**Logic Risetime:** TTL mode - typically  $<$  4 nsec.

ECL mode - typically  $<$  3 nsec.

**Note:** Technical specifications for the 9109 and 9100 are identical except for waveform memory length and digital outputs. Please consult 9100 technical data sheet for additional specifications.



# 9112 High Resolution Dual Channel Arbitrary Function Generator

## Main Features

**Dual Analog Outputs with 12-bit Amplitude Resolution** - The 9112 generates analog signals with outstanding fidelity. Dual 12-bit Digital to Analog Converters (DAC's) provide signal to noise ratio in excess of 70 dB. This allows the user to define a waveform with amplitude changes as slight as one part in 4,096 with low harmonic distortion. Coupled with amplitude flatness < 0.1 dB, the 9112 gives true, undistorted representations of the waveforms you need to generate.

**Digital Pattern Generation: 32-bits, 50 Megawords/sec** - Two 16-bit TTL channels with Channel 1 data corresponding to the Channel 1 analog output and Channel 2 data corresponding to the Channel 2 analog output. Since each analog channel output is based on the 12 MSB's of the corresponding 16-bit word, the 4 LSB's of each digital output can be used for other purposes.

**64 Kpoints High Speed Segmentable Fast Memory** - 64 Kpoints of fast memory (up to 20 nsec/point) is divisible into hundreds of different waveforms. Each of these segments may be assigned a repetition count, and "Linked" with other segments to provide the equivalent of billions of points of waveform memory.

**Non-Volatile Waveform Storage** - 175 Kpoints of non-volatile memory is provided for waveform, setup, or sequence storage. Non-volatile memory is loaded via GPIB or RS232 interface.



**10 V p-p (50  $\Omega$ ) Outputs with Automatic Load Compensation** - If the output load has a resistance of something other than 50  $\Omega$ , the user may select, optionally, to have the analog output automatically compensated. This will maintain DC accuracy for non 50  $\Omega$  systems and improves accuracy in 50  $\Omega$  systems.

**Generates User Definable Mixed Waveforms and Digital Patterns** - Two independent channels, each having a 12-bit analog and 16-bit digital output, make mixed mode analog/digital testing a reality. Both channels are strobed simultaneously to maintain excellent time correlation between channels. Each analog

channel uses separate 12-bit DAC's for independent control of amplitude, offset, and phase delay.

**EASYWAVE® Waveform/Pattern Creation Software (Optional)** - EASYWAVE is a complete waveform and pattern creation toolkit which runs on PC-DOS compatible computers. EASYWAVE is completely menu driven and allows for the creation of waveforms and digital patterns via several methods, including using existing building block waveforms from a simple waveform elements library, equations, or direct acquisition from any LeCroy Oscilloscope. All 9112 functions can be operated from EASYWAVE.



## Functional Description

The 9112 is designed to be a highly versatile multipurpose signal generator. Superior design and high quality components are integrated into a relatively simple design structure.

The 9112 consists of 6 essential sections: CPU, Non-Volatile Memory, High Speed Waveform Memory, Timebase and Triggering, High Speed 12-bit Digital to Analog Converters and 16-bit Digital Outputs.

### CPU

The CPU is responsible for executing all of the functions of the 9112. It is responsible for selecting the appropriate setup parameters, as well as loading the correct waveforms from the Non-Volatile

Memory into the High Speed Waveform Memory. The CPU also defines in what order, and with how many repetitions, each selected waveform is to be output.

### NON-VOLATILE MEMORY

The Non-Volatile Memory stores Waveform files, Setup files, and Sequence files. Waveform files provide a complete description of a waveform segment. Setup files store control parameters such as amplitude, clock rate, and triggering type and source. Sequence files store batch commands for automation of the 9112.

### HIGH SPEED WAVEFORM MEMORY

The High Speed Waveform Memory outputs the waveforms that the CPU has taken from the Non-Volatile Memory in

the order and with the proper number of repetitions that the CPU has assigned for each one. Thirty-two bit digital information can be output by this memory at up to 50 megasamples/sec.

### TIMEBASE AND TRIGGERING

The 9112 has a timebase which is adjustable from 50 MHz to 10 mHz. Inputs are provided for an external clock, external clock reference, and trigger/gate. The 9112 has 2 outputs for clocking external devices, sync output (which is output upon receipt of a trigger), start output (which is output with the first point of each waveform), and a user programmable marker output.

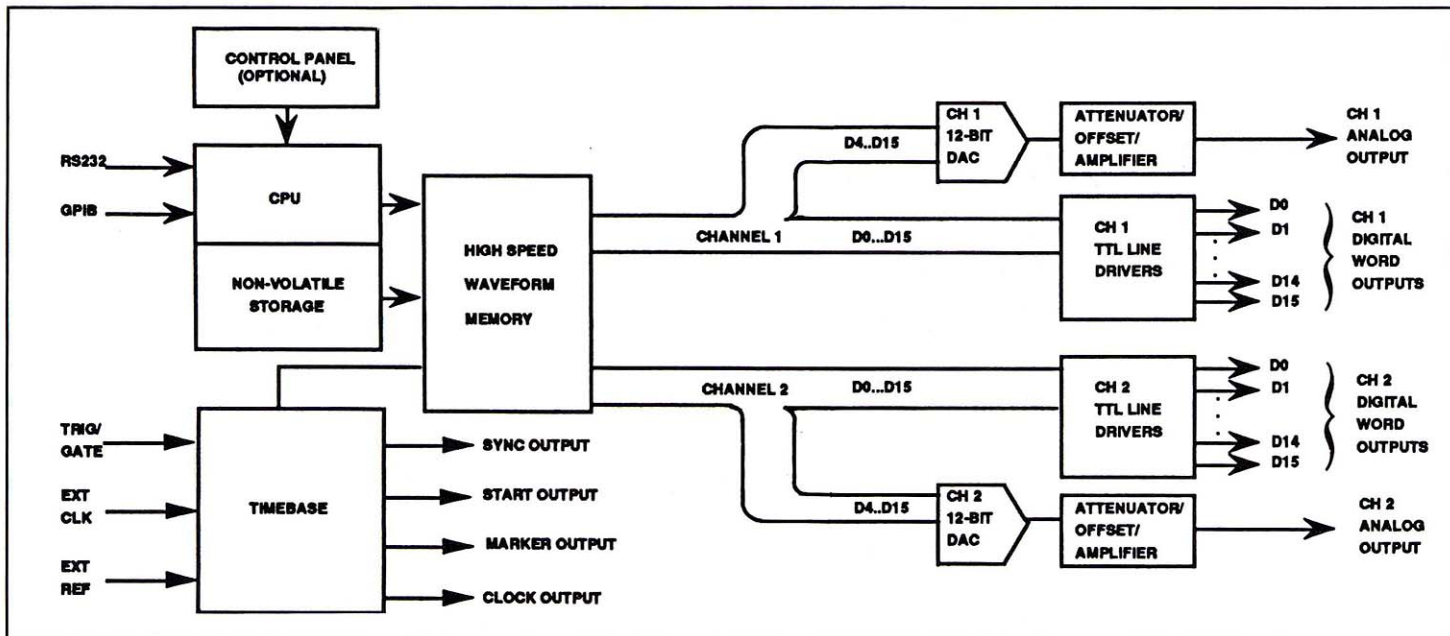



# Signal Sources

## 9112 Specifications

### WAVEFORM OUTPUTS

**Channels:** 2.

### D.C. OUTPUT CHARACTERISTICS

**Maximum Range (FSR):**  $\pm 5V$  into  $50 \Omega$ ;  $\pm 10 V$  into  $>10 K\Omega$  load.

**Maximum Output Current:**  $\pm 100$  mA

**Output Impedance:**  $50 \pm 0.5 \Omega$

**Minimum Amplitude Range:**  $100.0 \mu V$ .

**D.C. Output Accuracy (After calibration):**

No Compensation ( $50.00 \Omega$  Load):

$\pm 0.5\%$  FSR into  $50 \Omega$  for FS  $\geq 500$  mV

$\pm 1.0\%$  FSR  $\pm 500 \mu V$  into  $50 \Omega$  for FS  $< 500 \mu V$

Load Compensation:

$\pm 0.3\%$  FSR into user supplied load of from  $49 \Omega$  to  $1 M\Omega$  for FSR

$\geq 10\%$  of maximum Output Voltage Range.

**Waveform DAC Resolution:** 12 bits (4,096 levels).

**Gain Adjust Resolution:** 0.05% of full scale amplitude.

**Offset Adjust Resolution:** 0.05% of full scale amplitude.

**Offset Adjust Range:**  $\pm$  Full scale amplitude (wrt midscale of waveform); must be within output voltage range.

**Waveform Integral Non-Linearity:**

$< \pm 0.03\%$  typical;  $< \pm 0.05\%$  max.

**Waveform Differential Non-Linearity:**

$\pm 0.75$  LSB typical,  $\pm 1$  LSB max., monotonic

### DYNAMIC CHARACTERISTICS

**Risetime/Falltime:**  $\leq 8$  nsec., 5.5 nsec typ.

**Settling Time:**  $< 20$  nsec to 1% typical, 50 nsec max.

**Overshoot and Ringing:**  $< 5\%$ , typically 2%.

**Harmonic Distortion (1 V rms into  $50 \Omega$ ):**  
 $\leq -65$  dBc for output frequency  $\leq 200$  kHz;  
 $\leq -55$  dBc for output frequency  $< 1$  MHz;  
 $\leq -45$  dBc for output frequency  $< 5$  MHz (the sum of the first 4 harmonics less than Nyquist).

**Spurious and non-harmonic distortion:**  
Above 1 MHz -- 60 dBc; 1 MHz and below - 65 dBc.

**Interchannel Crosstalk:** .05% Tested with both channels at 10 V amplitude.

**Noise:** Signal to Noise ratio (non-coherent):  $> 70$  dB rms.

P-P Noise:  $\pm 0.1\%$  of full scale amplitude  $+ \leq 2$  mV (excluding glitch).

**Maximum Glitch Energy:** (50 pV $\cdot$ sec) times full scale amplitude.

**Time Base (Point Rate)**

**Range:** 20 nsec to 100 sec per point.

**Resolution:** 0.035%.

**Accuracy:** 5.0 ppm, within achievable set points, 23° C, 115 VAC/60 Hz, after 30 minute warmup.

**Stability:**  $< 0.5$  ppm /° C.

### STANDARD FUNCTIONS (WAVEFORMS)

**Sinewave:**

**Frequency Range -** 0.01 Hz to 6.25 MHz

**Frequency Resolution -** 0.035%

**Squarewave:**

**Frequency Range -** 0.01 Hz to 25 MHz

**Frequency Resolution -** 0.035%.

**Triangle:**

**Frequency Range -** 0.01 Hz to 6.25 MHz.

**Frequency Resolution -** 0.035%.

**Linearity -**  $\pm 0.1\%$ .

**Pulse (single channel only):**

**Period -** 160 nsec to 10 sec.

**Width -** Variable, 20 nsec to 10 sec (not to exceed period).

**Orientation -** Selectable, positive or negative going.

**Ramp**

**Period -** 160 nsec to 100 sec.

**Resolution -** 0.035%.

**Linearity -**  $\pm 0.1\%$

**Orientation -** Selectable, positive or negative going.

**DC:** Generates a D.C. level.

### TRIGGER MODES

**Continuous -** The waveform is continuously generated without interruption.

**Recurrent -** The waveform is cycled with a programmable delay of up to 1/2 million points (1/4 million in dual channel) between cycles. Number of waveforms per delay is programmable up to 65,535.

**Single -** Upon receipt of a trigger, the selected waveform is generated only once. The start of the waveform can be delayed from the trigger point by up to 1/2 million points (1/4 million in dual channel).

**Burst -** Upon receipt of a trigger, the selected waveform is generated the number of times set into the burst counter, up to 65,535. The start of the burst can be delayed up to 1/2 million points (1/4 million in dual channel).

**Gated (uses the trigger threshold) -** Uses a triggered start, and stops at the completion of the current waveform cycle after the gate closes.

**External Trigger Threshold:**

**Slope -** + or -

**Range -**  $\pm 2.5$  V

**Resolution -** 20 mV (8 bits)

**Source:**

**Manual -** Front panel button

**External -** External trigger applied via a front panel BNC

**Bus -** Trigger from GPIB or RS-232

**Hand Held Control Panel -** Trigger Key

**Arm Source:**

**Auto -** Automatically rearms itself.

**Bus -** Rearmed from the GPIB, RS-232 or the Hand Held Control Panel.

Trigger sources and arm sources may be individually enabled or disabled. Internal triggering is automatically selected in continuous or recurrent trigger modes.

**Delay:** Variable, from 2 to 1/2 million points

### WAVEFORM MEMORY

**Fast Memory Length:**

**Single Channel -** 64 Kpoints.

**Dual Channel -** 32 Kpoints each channel.

**Non-volatile Memory Length:**  $> 175$  Kpoints for waveforms, setup and sequence files.

**Load Time:** Non-volatile memory to waveform memory load rate, 225 msec + 0.6  $\mu$ sec/byte.

**Battery Back-up:**  $\geq 3$  years, non-rechargeable Lithium.

**Minimum Waveform Length:** Non-linked waveform segment, continuous mode only - 4 points (2 points dual mode). Linked waveforms, (any trigger mode):

**Single channel operation -** 36 points;

**Dual channel operation -** 18 points/channel.

**Waveform Length Resolution:**

**Single channel operation -** 4 point blocks.

**Dual channel operation -** 2 point blocks.

### OUTPUTS

**Front Panel:**

**Waveform Outputs -** Output impedance, 50  $\Omega$ .

**Analog Output Protection:** Protected against application of up to  $\pm 40$  VDC. If an externally applied overvoltage condition is detected, the output relay is opened, the LED for that channel is flashed and, if enabled, an SRQ is generated on the GPIB.

**All Timing Outputs -** Output impedance, 50  $\Omega$ . Source 1.5 Volts peak into 50  $\Omega$ . Approximately 75 nsec duration.

**Time Marker Output:** Settable from 2 up to 1/2 million clock cycles, referenced to the trigger point.

**Sync Trigger Output:** Occurs at the next Clock edge after receiving a Trigger.

**Waveform Start Output:** Occurs at the start of the waveform.

**Rear Panel:**

**Clock Outputs -** 0 to  $-0.8$  V into 50  $\Omega$ . Approx. a squarewave. Present in all modes in-



cluding External Clock. Runs at 2 times the point rate in single channel mode, 4 times the point rate for dual channel operation. Clock out 1 runs continuously. Clock out 2 is usable as Master in Master/Slave operation.

## DIGITAL WORD OUTPUTS

**Output Channels:** Two channels with Channel 1 data corresponding to the Channel 1 analog output. Channel 2 digital data corresponds to the Channel 2 analog output. Digital data is normalized so that a data value of 4,095 ( $FFF_{16}$ ) on the 12 MSBs of the digital word (D15-D4) corresponds to maximum analog amplitude and a data value of 0 on the 12 MSBs of the digital word corresponds to the minimum analog output.

**Maximum Digital Pattern Length:** Same as for Waveform Output.

**Digital Outputs Per Channel:** 16 data lines, clock, 17 grounds.

**Maximum Data Output Rates** (Identical to 9112 analog point rate): Single or Dual channel operation: 50 Megapoints/sec (20 nsec per word).

**Timing** (All outputs unloaded): Digital Clock to Analog Output: Clock precedes the Analog output by 1 clock period.

Digital Clock to Data: 4 nsec typical.

Clock Duty Cycle: 40% min., 60% max.

Hold Time Provided: 2 nsec minimum.

Setup Time Provided: 15 nsec min. at 50 Megawords/sec, typical setup time = (sample period) - (hold time).

Data to Data Skew Time:  $\pm 0.8$  nsec max. within each channel's data word.  $\pm 1.6$  nsec for any data line to data line.

Channel to Channel Skew: Clock:  $\pm 0.8$  nsec max.

Risetime: 5 nsec max (20%-80%).

Falltime: 3.5 nsec max. (20% - 80%)..

**Logic Levels (TTL Compatible):**

$V_{high}$  (min): + 2.7 V at + 1 mA.

$V_{low}$  (max): + 0.75 V at - 3.2 mA

**Absolute max applied voltages:** + 5.5 V, - 0.5 V.

**TTL Output Connector Configuration:**

Same pattern for Channel 1 and Channel 2.

All TTL outputs are single ended. Source impedance approximately 100  $\Omega$ .

Mating Connector: 3M Part Number 3421-7034 or equivalent. Two cable assemblies supplied.

## INPUTS

**Protection:** The maximum input voltage level for all inputs should not exceed 5 V.

**Front Panel:**

**External Gate/Trigger Input** - Impedance: 50  $\Omega$ .

**Keypad (Hand Held Control Panel) Input:**

A DIN connector is provided for attaching the hand held control panel.

**Rear Panel:**

**External Clock Input** - Impedance: 50  $\Omega$ . Threshold: Variable  $\pm 2.5$  V, 8 bits resolution.

**External Reference Input** - A signal on this input, if selected, causes the internal clock to phase lock to it. It requires a 4 MHz signal with 500 mV to 5 V p-p amplitude. 50  $\Omega$ , AC coupled.

## FRONT PANEL INDICATORS AND CONTROLS

**Controls:**

**Power** - ON/OFF

**Manual Trigger Button**

**Hand Held Control Panel** (optional)

**Indicators:**

**Power on LED** - ON when power is applied to the instrument.

**Trigger Armed LED** - ON when awaiting a trigger signal.

**Waveform Active LED's** -

Channel 1: ON when Channel 1 is turned on and the waveform is output or trigger pending.

Channel 2: ON when channel 2 is turned on and the waveform is output or trigger pending.

**Self Test LED** - ON when a self test or calibration is in progress.

**Test Fault LED** - Flashes for 10 seconds when a self test determines there is a fault or stays ON in the event of a microprocessor failure.

**Battery Low LED** - ON when the non-volatile memory backup battery is too low.

**Channel 1, Invert LED** - ON when Channel 1 output is inverted.

**Channel 2, Invert LED** - ON when Channel 2 output is inverted.

**GPIB:**

LED's for Talk, Listen, SRQ, and Local.

**Rear Panel Connectors and Switches**

**Connectors:**

GPIB: IEEE 488.1, 1978 compatible. RS-232: DB 25 S.

**Switches:** GPIB Address Switch, RS-232 Configuration Switch. Line voltage selector and fuses.

**Waveform/Pattern Creation and Editing**

LeCroy's EASYWAVE<sup>®</sup> software package is available for IBM PC- compatible computers. See EASYWAVE Technical Data Sheet.

## INSTRUMENT CONTROL

EASYWAVE provides full operational control of the 9112.

**Control Panel:** Once the waveforms have been loaded to non-volatile memory, an optional, detachable control panel (9100/CP) with a four line LCD display may be used for controlling the 9112.

**Other GPIB or RS-232 Compatible**

**Controllers:** Other computers or terminals may be used to control the instrument using the remote commands.

## GENERAL

**GPIB Interface Functions:** IEEE 488-1978 compatible. SH1, AH1, T5, TE0, L3, LE0, SR1, RL1, PP0, DC1, DT1, C0 .

**GPIB DMA Rates:** Typically  $\geq 200$  Kbytes/sec.

**RS-232C:** Implemented as Data Communications Equipment (DCE).

**Commands:** Same as GPIB.

**Temperature Range:** 15° C. to 35° C., full specification; 0° C. to 40° C., operating.

**Humidity:** 40° C., 10% to 95% relative, non-condensing.

**Power:** 115/220  $\pm 20\%$  VAC, 47-63 Hz; nominally 147 watts. 440 Hz contact factory.

**Size:** 5-1/4" H X 19" W X 15" D. Weight: 26 lbs.

## OPTIONS and ACCESSORIES

<b>9100/CP</b>	Detachable Hand Held Control Panel
<b>9100/EC</b>	6' Extender Cable (Control Panel)
<b>9100/MM</b>	Multiple Memory Expansion - 512 Kbytes (256 Kpoint) waveform memory, 1 Mbyte (512 Kpoint) non-volatile memory. (Available 3/90)
<b>9100/RT</b>	Realtime waveform segment addressing (Available 3/90)
<b>9112/OM</b>	Operator's Manual
<b>9112/SM</b>	Service Manual
<b>9100/SW</b>	EASYWAVE Software
<b>9100GPIB2</b>	GPIB interface card and software National Instruments PCII Card and GPIB-PC Software )
<b>DC/GPIB-2</b>	GPIB Cable, 2 meters
<b>FILTER/36MHz</b>	36 MHz low pass filter (1 included with unit)



# Signal Sources

## 9100/SW EASYWAVE® Software

The LeCroy EASYWAVE® software package converts your IBM PC compatible into a powerful, menu-driven tool for the generation of customized arbitrary waveforms. EASYWAVE can be used independent of the AFG for waveform creation and editing. Coupled with your LeCroy Arbitrary Function Generator you can develop waveforms and down-load to the AFG's non-volatile memory, from which they can be retrieved and output through the AFG's high speed waveform memory.

EASYWAVE creates waveforms with pushbutton ease from a library of common waveforms, from algebraic equations, or tabular point by point data entry. Waveforms, captured with a LeCroy digital oscilloscope, or one of LeCroy's many modular digitizers or transient recorders, may be transferred to EASYWAVE for editing or processing. During waveform creation and editing the waveform is always visible.

As a control program, it provides simple and intuitive control of every 9100 Series feature using either direct manual control, or automatic command sequence files.

### Main Features

#### SIMPLE ELEMENTS

Resident in EASYWAVE are nine commonly used waveforms...sine, DC/step, square, ramp, triangle, exponential, Gaussian pulse, damped sine, and frequency sweep. Selecting any of these waveforms requires just one keystroke. As an example, a damped sinewave can be created by simply entering an "M". Capitalized letters designate each of the particular simple elements.

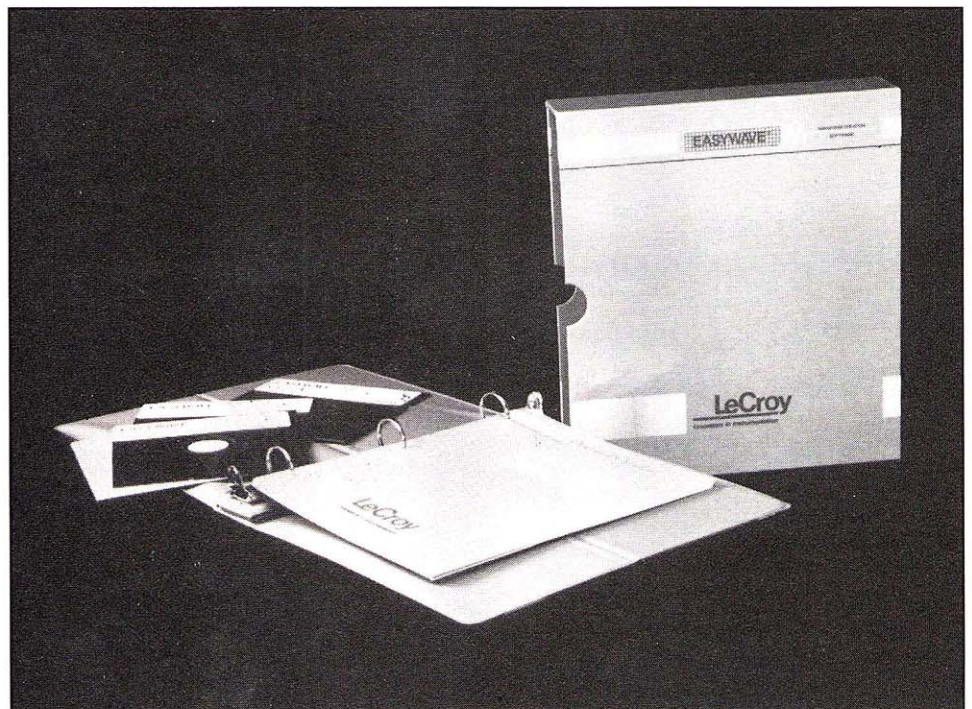

The next screen menu allows you to enter the parameters of the damped sine; that is, the frequency or period, vertical scaling, starting phase, and exponential time constant. By keying in the desired values, EASYWAVE calculates the waveform and displays it on the monitor. Other simple elements are created in the same manner.

Waveforms created from simple elements or by other methods can be stored in computer memory, recalled for future editing, or downloaded to the non-volatile memory in the AFG. When stored in the AFG, waveforms are instantly available for file transfer to the high speed waveform memory by simply entering the file name.

#### EQUATION ENTRY

EASYWAVE creates waveforms from their mathematical description entered in normal algebraic notation. EASYWAVE accepts the functions, operators, and variables as shown below.

Functions	Operators	Array Variables
sin	Add (+)	
ln	Subtract (-)	
cos	Multiply (*)	C - current waveform in channel 1
exponent	Divide (/)	
tan	Exponent (^)	
abs. value		
log		
square root		
Rn expression line n		D - current waveform in channel 2
Noise		
Pulse		
Step		



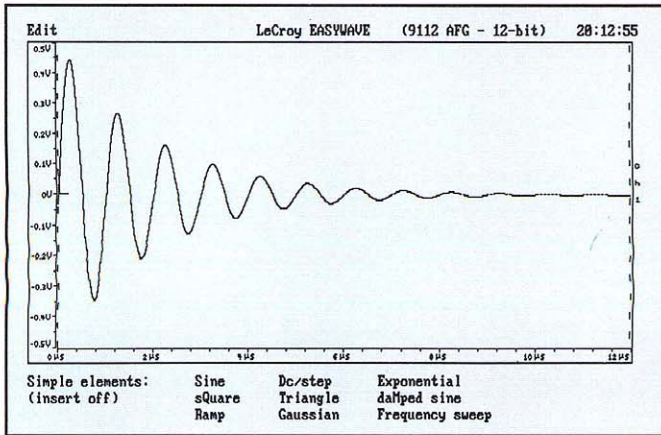

Damped sinewave created from simple elements

As an example of mathematical entry, let's create a  $\sin x/x$  waveform. By entering the equation editor, we can build the waveform in two steps...first the  $\sin x$  expression and then the  $x$  expression. Entering the third line in R3, as R1 divided by R2 and execute it, we have now created the desired waveform.

## TABULAR ARRAY

Array entry is used primarily as a convenient tool to edit a previously created waveform.

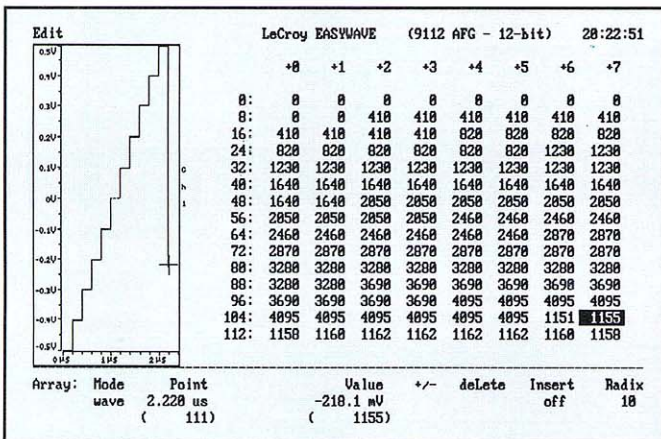

Tabular Array

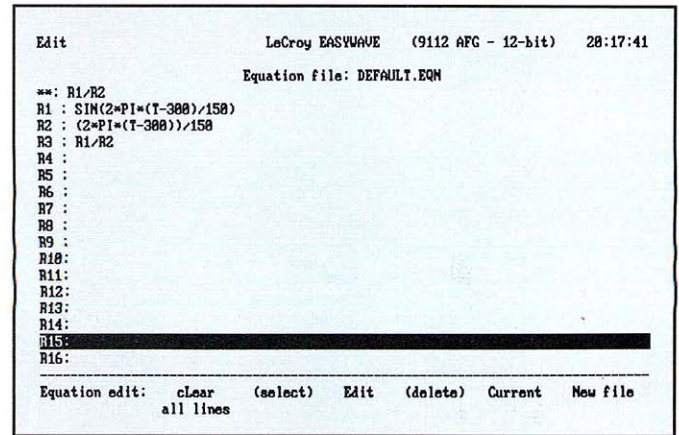

Equation File Display

A waveform discontinuity is difficult to express as a mathematical formula but easy to enter as a series of connected points. Consider as an example a series of pulses of varying amplitude, duration and repetition rate.

The array menu and screen permits the option of entering data values into the waveform on a point by point basis. As the data array is filled in on the screen, the waveform is simultaneously displayed.

## WAVEFORM CAPTURE

Waveform capture with EASYWAVE provides a powerful tool that allows recreating real-world signals from digital oscilloscopes and transient recorders. Data files in ASCII format can also be input to EASYWAVE. Once captured, such waveforms can be stored, recalled, edited, and then output by the AFG to test equipment under actual operating conditions.

EASYWAVE is designed to work directly with LeCroy's 9400 Series Digitizing oscilloscopes by means of a file transfer. Consider a typical waveform as displayed by the 9400A.

A simple file transfer operation will transfer this waveform into the EASYWAVE waveform display. The next menu asks you to identify which of the two 9400A channels is to be the source waveform. The resulting EASYWAVE captured waveform is a faithful replica of the oscilloscope signal including current transfer of all control settings.



# Signal Sources

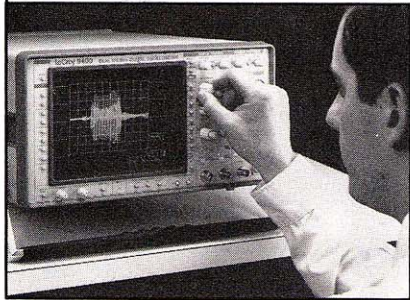
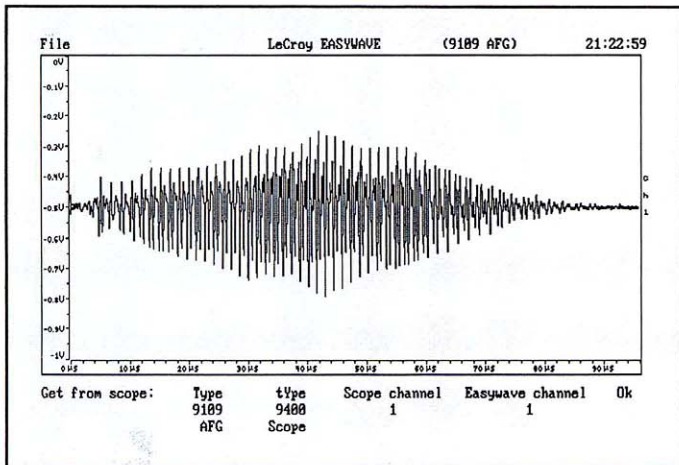

*Captured waveform as recreated by EASYWAVE*

*Oscilloscope capture of a voice waveform*

## WAVEFORM EDITING, BLOCK ACTIONS

EASYWAVE's graphical waveform editing and block actions are used to insert, delete, or modify groups of data points (blocks). Data blocks may be transferred from or to disk. Modifications include horizontal or vertical scaling and vertical offset.

Waveform editing by means of block actions allows you to extract a prescribed section or block of a created waveform, transfer this block to disk storage, put the block in a buffer storage for further editing, delete the entire block, and re-scale or slide the block either vertically in amplitude or horizontally in time.

As an example of waveform editing by block actions, let's assume that we wish to create a waveform consisting of a damped sine wave to a square wave. These two separate waveforms are available as simple elements.

By entering start and stop points, specific points on a waveform can be located for block actions. These limits are outlined by the edit markers. First set the start and stop points to put the damped sine into the block buffer. Then change the start point and insert the buffer contents, the damped sinewave, into the squarewave.

## OPERATE

EASYWAVE provides on-line control via the GPIB of all 9100 Series features and settings with full screen display.

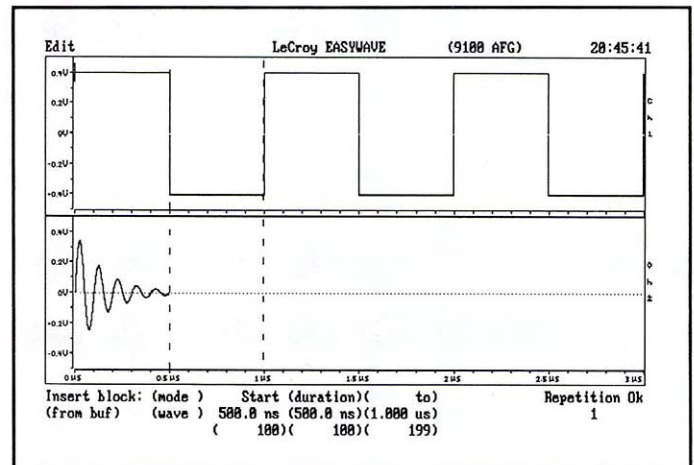

*Square wave on Channel 1 and a damped sine on Channel 2, both created from simple elements*

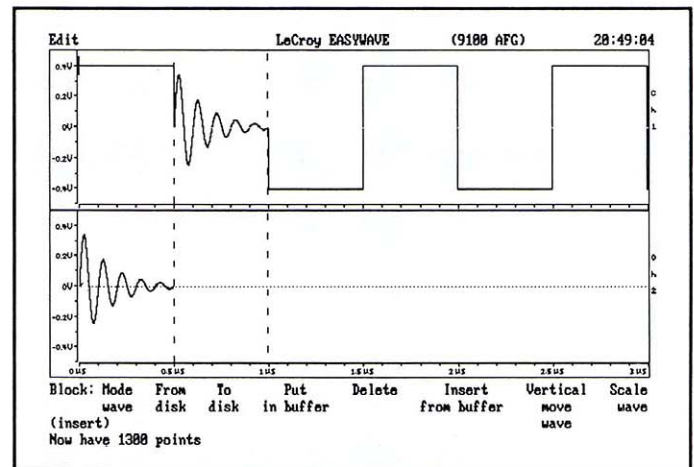

*Channel 1 now provides the composite waveform of a damped sine inserted into a square wave*

Setup, sequence, and waveform files can also be created and stored, with or without the AFG attached, for later transfer to the 9100 Series RAM disk.

The Operate mode is accessed from the System menu. A choice is provided of operating the 9100 Series as a standard function generator, a pulse generator, or as an arbitrary waveform generator. In addition, the 9100 Series can be commanded to initiate a self-test routine, automatically calibrate itself, and identify its firmware revision level.



```
Operate Mode:  Function  Pulse  Arbitrary  Selftest  Calibrate  Identify
                generator generator generator  afg      afg      afg
```

## Operate Mode Menu

```
System menu:  Configure  Edit  File  Operate  <F1>  <F2>  <F3>
                mode      mode  transfer mode  help  exit  display
EASYWAVE Version 2.83                                <F4> returns to this menu
```

## Action Menu

```
Configure:  Gpib  Name  Afg  Type  Scope  tType  dMa  Join  dots  Help  Colors
            8  GPIB8  1  9189  4  No  on  on  on  on
```

## Configure Mode Menu

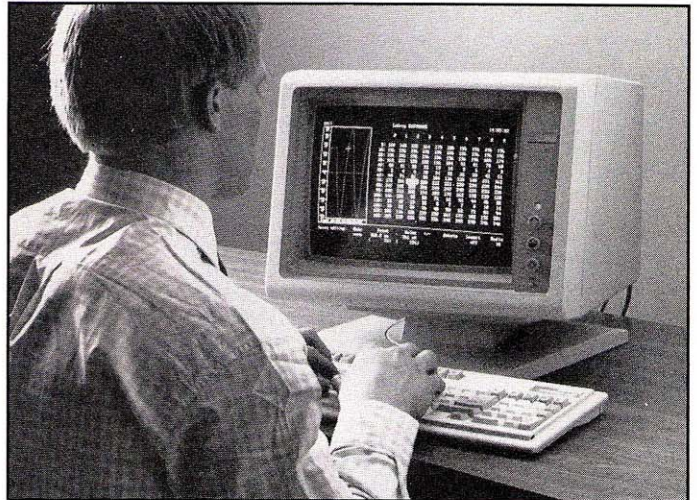

*Test engineer utilizing EASYWAVE software to create his own library of custom waveforms for rapid implementation in an ATE environment.*

The Operate mode permits loading a waveform in the 9100 Series waveform memory under a file name. A loaded waveform can be looped on itself up to 4,096 times. A loaded waveform can also be linked with other waveform segments to form a new composite waveform.

The Action menu provides the tools needed to control the output of the AFG, including Go, Stop, and Abort commands as well as arming and triggering commands. In addition, you can use this menu to recall a complete 9100 Series setup from a file or run a complete sequence commands from a file.

Sequence files provide great versatility in that they allow the automation of a series of setup commands and waveforms by merely calling up one sequence file by name. In this way, a whole battery of waveforms can be output by the AFG, to conduct a series of tests automatically.

Typical sequence file shows the settings for both channels of the 9100 Series, trigger information, loaded waveform, and start command. Sequence files can be edited after creation, line by line, or lines inserted or deleted.

The Configure mode allows entry of GPIB information, including the bus addresses of the controller, 9100 Series, and 9400 Series Digital Oscilloscopes, if present. The menu also provides the ability to turn the direct memory access on or off, instruct the AFG to display individual waveform data points or join them to produce a continuous waveform, turn HELP screens on or off, and select display colors. A choice of 15 colors are available to delineate the two channels of the 9100 Series; the zero reference lines, the display frame, alphanumeric information, and cursors.



# Signal Sources

## 9100/SW Specifications

### WAVEFORM CREATION AND ACQUISITION

Waveforms, to be generated by the LeCroy 9100 Series Arbitrary Function Generator may be created directly or captured from a LeCroy 9400 Series Digital Oscilloscope. Utility programs for transforming LeCroy CATALYST™ Transient Recorder or Digitizer Data Files into EASYWAVE waveform file format are also provided. Waveform files in ASCII format may also be input.

### WAVEFORM CREATION TOOLS

**Simple Elements** - select and build complex waveforms using simple waveform segments including:

- Sine
- Ramp
- DC/Step
- Square
- Exponential
- Gaussian Pulse
- Damped Sine
- Frequency Sweep
- Linear or Logarithmic

Amplitude, frequency, time, and phase attributes of each simple element are user adjustable.

**Equation Array** - create a waveform by direct entry of analytic equation. Permitted operations are addition, subtraction, multiplication, division, and exponentiation. Functions supported are Absolute Value, Cosine, Sine, Exponent, Common Logarithm, Natural Logarithm, Sine, Square Root, and Tangent. Parentheses for specifying the order of operations and serial operations are available. Add noise to any function.

### DATA ACQUISITION TOOLS

Direct transfer of waveforms from either channel of a LeCroy 9400 Series Digital Oscilloscope.

CATWAV utility program for converting CATALYST data files.

ASCII file input.

### WAVEFORM EDITING

Array: Direct data point value insertion, increment or decrement values, deletion.

Block Actions: Insert, delete, or modify groups of data points (Blocks). Data blocks may be transferred from or to Disk. Modifications include horizontal or vertical scaling and vertical movement (offset).

### SEQUENCE FILE GENERATION AND EDITING

Generate and edit Sequence files for automating a series of AFG control and/or operational commands. Transfer Sequence file to or from Disk files or the AFG.

### SETTINGS FILES

Modify, Store, and Recall 9100 control settings. Transfer Setting files between EASYWAVE, the Arbitrary Function Generator, or Disk.

### FILE TRANSFER OPERATIONS

Transfer Waveform, Sequence, and Settings files between EASYWAVE, the 9100, and disk. Delete selected files. Select and List file Directories in AFG or from Disk.

### OPERATE ARBITRARY FUNCTION GENERATOR

Control the AFG as a Function, Pulse, or Arbitrary Function Generator. Select, load, link, and loop desired waveforms. Start, stop, arm trigger, advance to next, or abort output waveforms. Set the output parameters of each channel including Amplitude, Offset, and Filter cutoff frequency. Turn each channel on or off, select invert or sum output channels. Adjust Clock period or frequency, pulse width, start phase or relative phase of outputs. Select trigger modes, trigger slope/level, and trigger source.

### CONFIGURE INTERFACE

Set IEEE-488 operating configuration. Select Device addresses, Adaptor name, Display Colors, Control direct memory access (DMA ON, OFF). Turn HELP ON or OFF.

### PHYSICAL DESCRIPTION

EASYWAVE is supplied on three double sided, double density (360 Kbyte formatted) 5-1/4 inch disks (3-1/2 inch disks are available upon request), including install disk, program disk, and a waveform/utility disk.

EASYWAVE runs on IBM XT/AT computers and 100% compatible computers with a hard disk drive, 640 Kbytes of random access memory, and a color graphics, enhanced graphics, or Hercules monochrome graphics adaptor. It requires a National Instrument PC2 GPIB Adaptor and associated software support package (not supplied) for control of the LeCroy 9100 Series Arbitrary Function Generators.



## COMMON WAVEFORMS CREATED WITH EASYWAVE

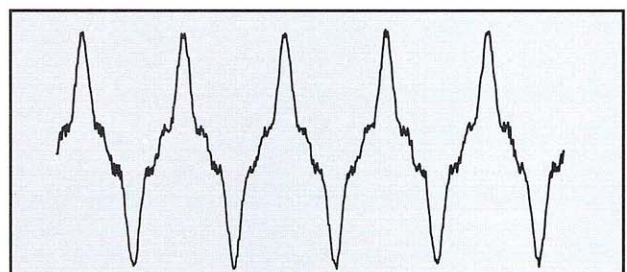
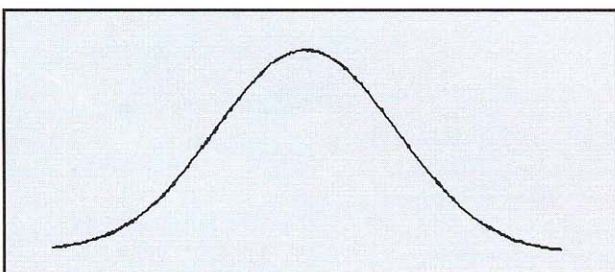
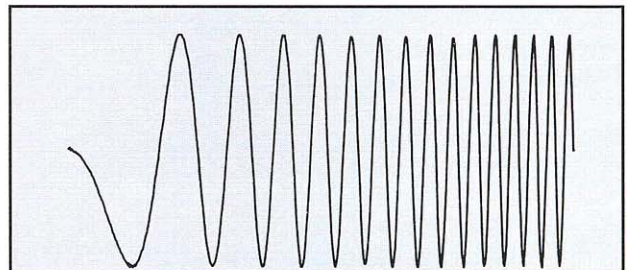
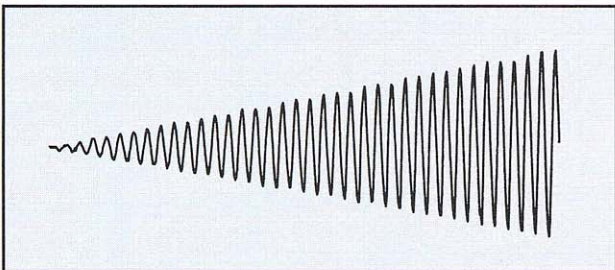
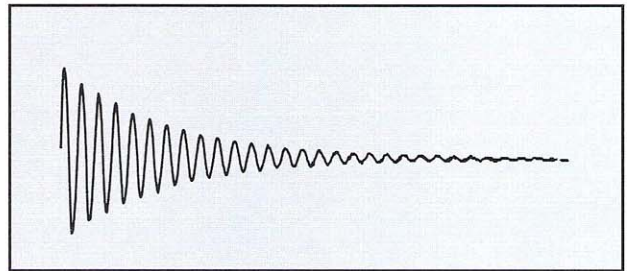
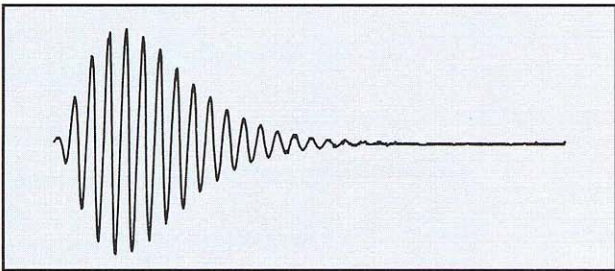
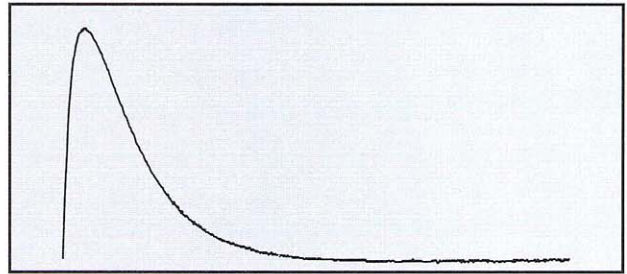
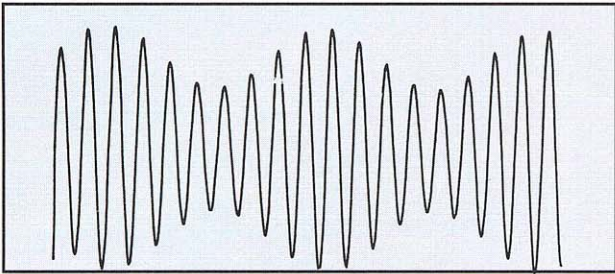



# LeCroy Waveform Digitizers are Powerful and Flexible

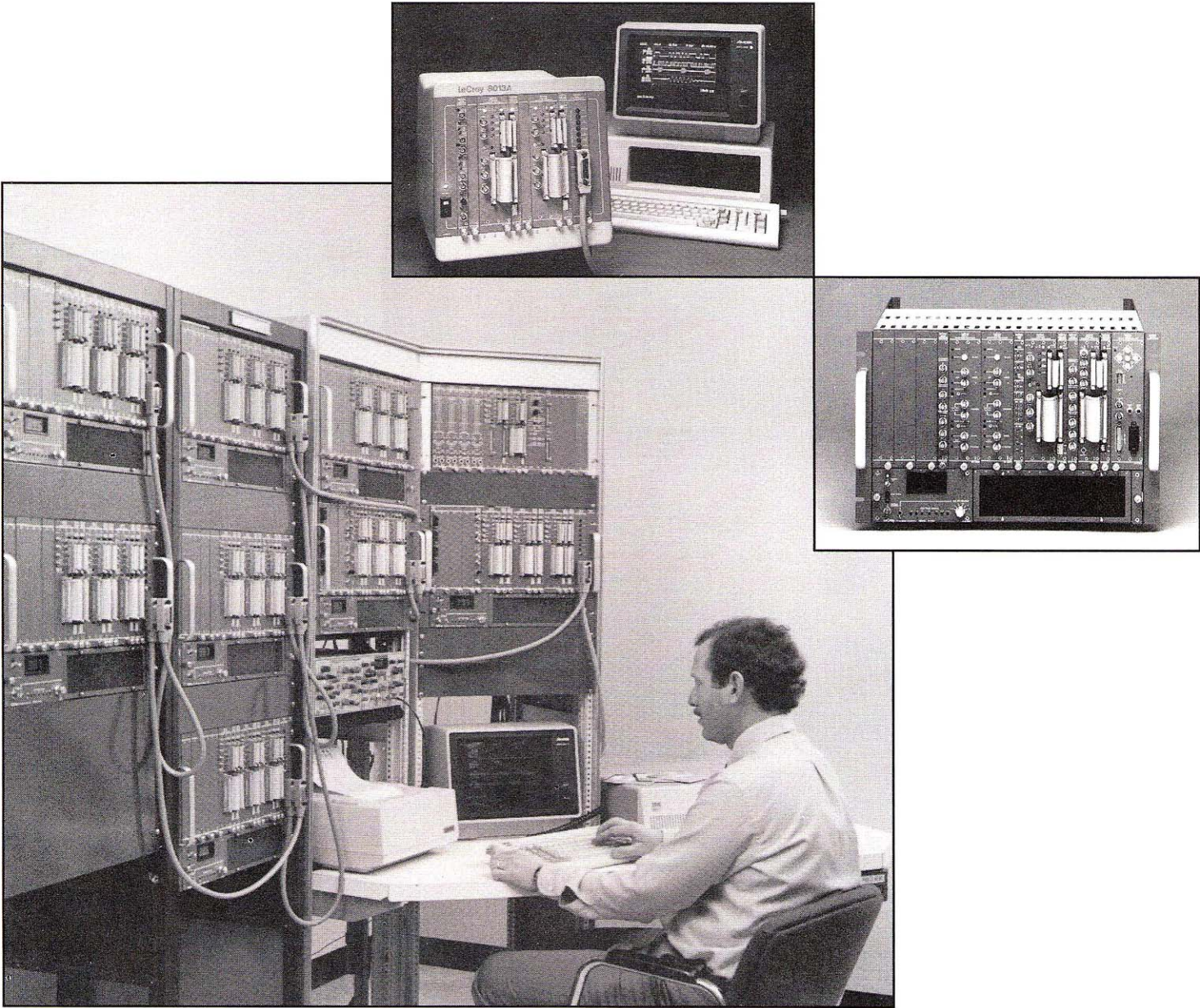



## Modular Products Location Guide

Model	Description	Page No.
<b>Digitizers and Memories</b>		
6880B	1.3 GS/s Waveform Digitizer	III-6
TR8818A	100 MS/s Waveform Digitizer	III-12
TR8828D	200 MS/s Waveform Digitizer	III-12
MM8103A/04/05/06	Memory Modules	III-12
6309/6389	Snapshot Long Memory Recorder	III-17
7900 Series	Wavecorder Ultra-Wide Memory Digitizers	III-20
6810	Quad 5 MS/s 12 Bit Digitizer	III-24
8212A	32 Ch. 100 KS/s 12 Bit Digitizer	III-30
2262	Quad 80 MS/s Digitizer	III-32
Accessories	Cables,Computers,Connectors,7900 Series	III-35
<b>Amplifiers, Attenuators, Fiberoptic Transmitters/Receivers</b>		
6103	Dual Amplifier/Trigger Generator	III-36
8102	6-Channel Attenuator	III-36
5612/13	Fiberoptic Transmitter/Receiver	III-39
<b>Pulse, Gate, Clock Generators</b>		
2323A	Dual Delay Gate Generator	III-42
4222	Quad Delay Gate Generator	III-42
6128	8-fold Fan Out and Level Adapter	III-46
<b>Controllers, Interfaces, Averagers</b>		
6010	System Interface and Controller	III-48
8901A	GPIB System Interface	III-54
<b>System Software and Control</b>		
6900	Waveform CATALYST PC Software	III-56
6910-Dev	Software Development Package	III-59
6920	ASYST Software and Digitizer Drivers	III-63
<b>Mainframes</b>		
1434A	650 Watt Powered Mainframe	III-71
8013A	400 Watt Powered Mainframe	III-71
8025	1000 W Powered Mainframe	III-74
<b>Other Products</b>		
Time Digitizers		III-78
Programmable High Voltage Distribution		III-78
Custom Hybrids and Monolithics		III-79
<b>Introduction to CAMAC</b>		
		III-80



# Modular Digitizer Systems

## About Modular Digitizer Systems

### WHY WAVEFORM DIGITIZERS?

LeCroy waveform digitizers offer the measurement benefits of digital oscilloscopes, plus several more. Similar to LeCroy oscilloscopes, they can accurately record both transient and repetitive signals, capturing both pre- and post-trigger information.

LeCroy waveform digitizers have several powerful capabilities beyond those of digital oscilloscopes. These features include:

- Expandable memory (>10 times longer than oscilloscopes)
- Up to 200 channels per chassis
- Flexible systems integration
- Real-time signal analysis

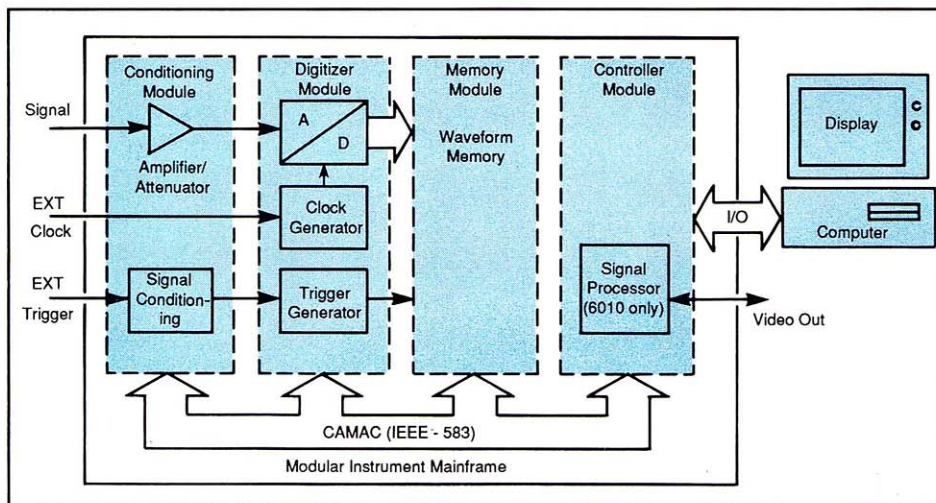

*CAMAC Waveform Digitizer Block Diagram.*

*Transient Digitizing Oscilloscope Block Diagram.*

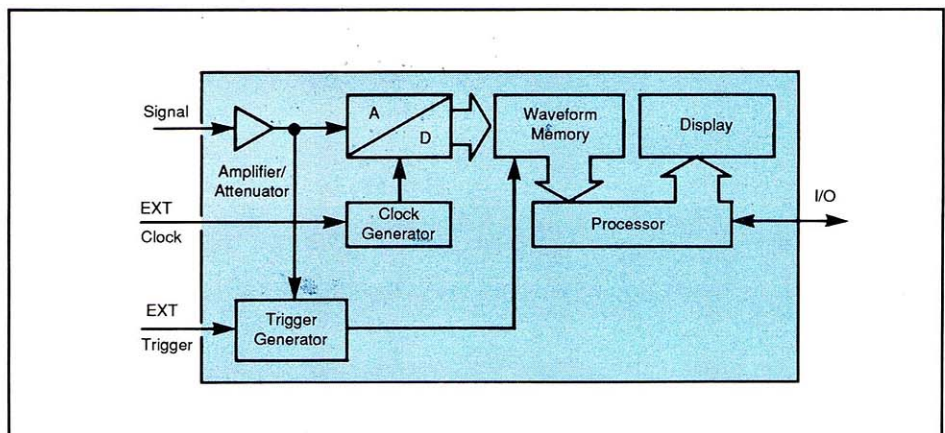



For applications requiring highly interactive operation and not needing the unique modular benefits, LeCroy digital oscilloscopes provide the best solution.

## LONG MEMORY

Long waveform memory lets you record long events without having to slow down your sampling speed. Thus, you can capture the signal of interest, even if a trigger is not available.

The accuracy of most analyses increases with waveform memory length. Waveform digitizer memory length determines frequency domain resolution with Fast Fourier Transforms (FFT). Long memory ensures accurate pulse parameter calculations by maintaining the digitizer sample rate at its maximum. Pulse parameter calculations can also be enhanced by capturing several pulses with long waveform memory and then averaging.

## MULTIPLE CHANNEL APPLICATIONS

A basic waveform digitizing system consists of a signal conditioning module, a waveform digitizer module, a memory module, a GPIB (IEEE-488 Standard) interface module, a module chassis, and a host computer. Each digitizer module contains its own analog to digital converter and sample clock. Each digitizer module uses its own dedicated and expandable waveform memory. Therefore, the high accuracy, fast sample rate, and long waveform memory of a single channel can be maintained in multiple channel applications.

A large number of channels can fit within a one foot high, rack mount instrument chassis. Each chassis uses only one GPIB interface. Up to 14 chassis can be combined into a single system via external triggering, clocking, and the IEEE-488 bus. A common power supply in each chassis minimizes power consumption.

Multiple LeCroy waveform digitizers can synchronously sample a high-speed event. External clock and external trigger interconnections to each module create a single clock input and single trigger input for the entire system. When the trigger event occurs, all channels record. Each digitizer then contains digitized waveform data which occurred at the same time as the waveforms recorded by all the other channels. "Armed" and "triggered" outputs on each digitizer can be used to verify proper system setup and good data.

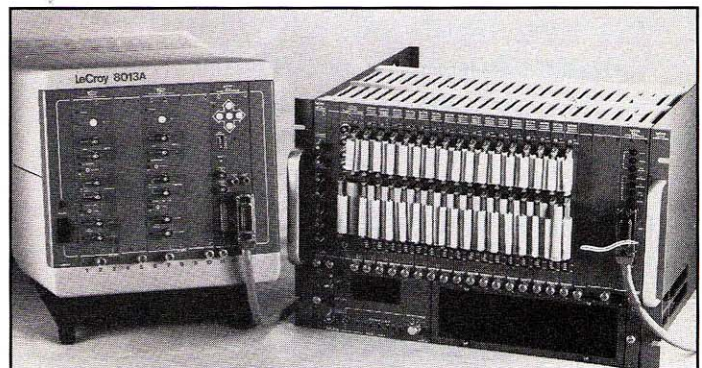

Typical Modular Waveform Digitizer Systems.

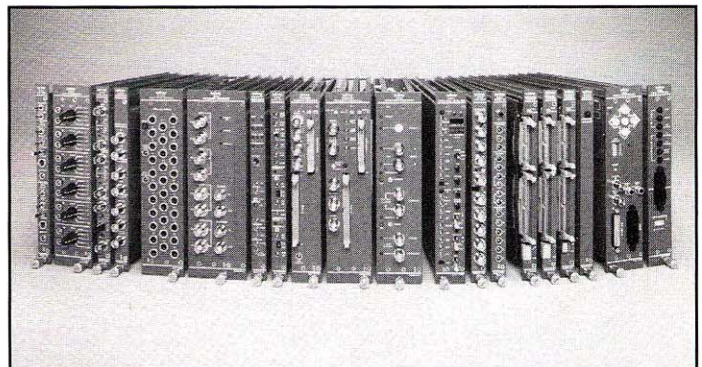

A small sampling of the wide choice of modules available in the CAMAC standard.

REQUIREMENT	SOFTWARE SOLUTION			
	6900-5	6920-DL	6920-488	6910-DEV
Turn-key, no analysis	X			
Turn-key with off-line analysis	X		X	
Integrated acquisition and analysis		X	X	
Ultra-fast acquisition and analysis		O	O	X

X = required O = optional



# Modular Digitizer Systems

## Digitizer and Memory Quick Selection Chart

DIGITIZERS	6880B	TR8828D	TR8818A	2262	6810	8212A
Maximum Digitizing Rate	1.3 GS/sec	200 MS/sec	100 MS/sec	40/80 MS/sec	1/2/5 MS/sec	40 kS/sec
Sample interval	742 psec	5 nsec - 0.3 msec	10 nsec - 0.6 msec	25 nsec/12.5 nsec	200 nsec - 50 msec	25 msec - 5 msec
Analog Bandwidth	500 MHz	120 MHz	120 MHz	40 MHz	2.5 MHz	50 kHz
Aperture Uncertainty	5 psec	5 psec	10 psec	150 psec	50 psec	2 nsec
Amplitude Resolution	8-11 bits	8 bits	8 bits	10 bits	12 bits	12 bits
Channels Per Module	1	1	1	4/2	4/2/1	32/16/8/4
Maximum Channels/GPIB	84	70	98	280	280	3136
Input Impedance	50 Ω	50 Ω	50 Ω	50 Ω	1 MΩ	1 MΩ
Voltage Range	512 mV p-p	512 mV/5.12 V p-p	512 mV p-p	1.53 V p-p	400 mV - 100 V p-p	10 V p-p
Digitizer (Width Slots)	3	3	2	1	4	3
<b>WAVEFORM SAMPLE MEMORY</b>						
Maximum Samples Stored	10k	640M	640M	1264	8M	256k
Included on Digitizer	10k	None	None	1264	512k	32
Expansion Modules	None	<ul style="list-style-type: none"> <li>• 32k/one MM8104 (32k max.)</li> <li>• 64k/pr. MM8103 (2M max.)</li> <li>• 256k/pr. MM8105 (2M max.)</li> <li>• 1M/pr. MM8106 (2M max.)</li> <li>• 16M: SnapShot™ System</li> <li>• 40M-640M: WaveCorder™ System</li> </ul>	<ul style="list-style-type: none"> <li>• 32k/MM8103 (2M max.)</li> <li>• 128k/MM8105 (2M max.)</li> <li>• 512k/MM8106 (2M max.)</li> <li>• 16M: SnapShot™ System</li> <li>• 40M-640M: WaveCorder™ System</li> </ul>	None	512k/6310 Module	<ul style="list-style-type: none"> <li>• 32k/8800A Module (128k max; 256k max. with 8212A Mod. 200)</li> </ul>
<b>SPECIAL FEATURES</b>						
Features	Video out, manual or remote control, adjustable trigger level, battery backed-up memory, pre- and post-trigger, delayed trigger, 3 dB headroom beyond full scale.	Burst mode for multiple transients, variable internal and external clock, adjustable trigger threshold, battery backed-up memory, pre- and post-trigger.	Battery backed-up memory, pre- and post-trigger, variable internal and external clock.	Optional plug-in oscillator crystals, voltage offsets, offset monitor points, variable external clock.	Dual programmable timebases, segmentable memory, hysteresis and window triggering, time stamps, differential inputs, variable internal and external clock, pre- and post-trigger.	Differential inputs, variable internal and external clock.



In contrast, building a many channel digitizing system from digital oscilloscopes limits channel expansion, consumes excessive space, and degrades channel coherence. For system integration, each oscilloscope requires its own GPIB address. The fixed number of channels and limited number of usable GPIB addresses (14) limits the number of channels per system. Multiple channel oscilloscope systems require much more space than modular digitizers due to the repeated display screen, power supply, and interface port. Plus, few oscilloscopes have external clock capability. Synchronized clocks are necessary to guarantee channel to channel coherence.

## FLEXIBLE SYSTEMS INTEGRATION

Different waveform digitizer modules can be combined in one chassis or system for added measurement performance. For example, an ultra-high-speed module and a high-resolution module can be triggered together and simultaneously record the same signal. The result is a complete waveform record containing extremely detailed time and voltage information on points of interest.

LeCroy waveform digitizers conform to the IEEE-583 Modular Instrumentation Standard (CAMAC). The standard specifies consistent programming codes, module size, power consumption, and shielding. Over 2,000 different instruments are available from numerous vendors. System integrators can more easily create high-speed measurement and control systems using IEEE-583 instruments than with most other standards. Additionally, complex or multichannel systems take up much less power and space.

## REAL-TIME ANALYSIS

For PC control, LeCroy offers either WAVEFORM-CATALYST Software or ASYST Scientific Software packages. For applications which require high-speed custom analysis or control, LeCroy offers custom in-chassis processing capability. Rather than transfer waveform data across the GPIB for analysis in the computer controller, customers may write their own software for the 6010 CAMAC controller module. Processing within the CAMAC chassis prevents throughput bottlenecks caused by the GPIB. The 6010 contains a powerful 68020 processor and 68881 floating point co-processor for high speed calculations. The 6910-DEV Development package supplies all the tools needed for writing and downloading these C-language programs.

## HOW TO CONFIGURE A SYSTEM

Step 1: Choose the number of channels and the digitizer models desired.

Step 2: Determine the number of waveform memory modules for each channel (see the digitizer data sheets for memory module configurations).

For continuous recording:

Required memory = (sample rate) • (recording time)

For burst recording:

Required memory = (sample rate) • (recording time/segment) • (# segments)

Step 3: Select trigger fan-out modules or trigger delay generators, as desired.

Step 4: Choose a CAMAC-to-GPIB interface, one per chassis.

For an RS-232C interface, 6880B digitizer operation, real-time analysis, averaging faster than 1 waveform per second, and/or simple ASCII programming (mnemonic commands), use the 6010 interface.

Step 5: Sum the total number of slots required by the modules selected and determine the number of chassis required to accommodate the modules. Choose the Model 8013A (13 instrument slots, 400 W module power), 1434A (25 slots, 650 W), or 8025 chassis (25 slots, 1000 W) to match your module needs.

Step 6: Select a host computer programming language. For PC control, select either LeCroy Model 6900 or 6920 software packages. Or write your own instrument drivers and programs using your favorite language.

The Model 6900 WAVEFORM-CATALYST Software provides turnkey data acquisition on up to 100 channels (80 with 6810 digitizers) in up to 14 mainframes. It displays 4 channels of live or stored waveforms with dual cursor measurements, zoom expansion, waveform averaging, histogramming, pass/fail limits testing, and command autosequence. Hundreds of user-named setups can be stored and recalled.

Model 6920-488 ASYST Scientific Software offers fully integrated waveform data acquisition, analysis and display graphics. It includes thousands of prewritten functions, such as FFTs and waveform math. Plus, LeCroy has already written simple-to-use drivers for all the waveform digitizers. Operation is either interactive or via programmed execution of commands and functions.



## 6880B Waveform Digitizer

### Main Features

- 1.3 GS/sec digitizing rate
- DC-500 MHz typ. bandwidth
- Up to 11-bit resolution
- Deep 10,000 sample point waveform memory
- Pre- and post-trigger data capture

### General

The fast sampling 6880B Waveform Digitizer accurately records up to 7.4  $\mu$ sec of 500 MHz transient signals.

A host computer or instrument controller can retrieve this waveform data via an IEEE-488 standard interface bus or via RS-232C lines. State-of-the-art LeCroy custom hybrid and monolithic components and a thorough self-calibration provide outstanding performance.

The 6880B provides an ideal waveform capture solution for numerous applications including the following:

- Electro Magnetic Pulses
- Pulsed laser responses
- Lightning studies
- High-speed mechanical shock
- Electronic circuit design

### TRANSIENT CAPTURE

A 6880B Waveform Digitizing System consists of a 6880B Waveform Digitizer module, a 6010 Controller/Interface module, an instrument mainframe, and either a monitor or host computer. The

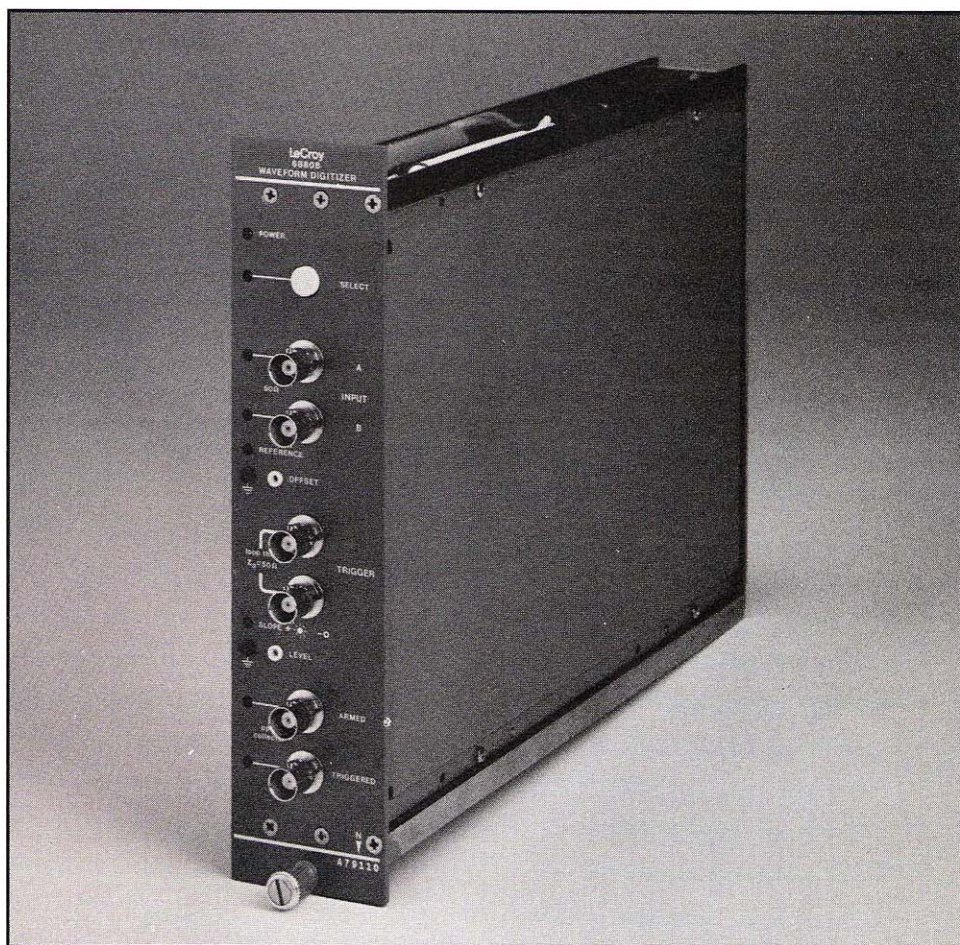

6880B Waveform Digitizer module converts up to 500 MHz analog signals into digital data and stores 10,016 points in battery backed memory. The 1.35 GS/sec digitizing rate captures fast waveform edges and subtle waveform details. The 6880B module contains one analog-to-digital converter which digitizes the signal on channel A, B, or A+B summed. The 6010 interface and control module provides a GPIB and RS-232C interface for 6880B remote/

automated control and for data transfers to a host computer. The 6010 also allows manual 6880B operation. Each mainframe containing up to six 6880B Waveform Digitizers requires only one 6010 Interface.

### HIGH RESOLUTION ANALOG TO DIGITAL CONVERSION

The 6010 interface module enables readout of either 8-bits or a full 11-bits of



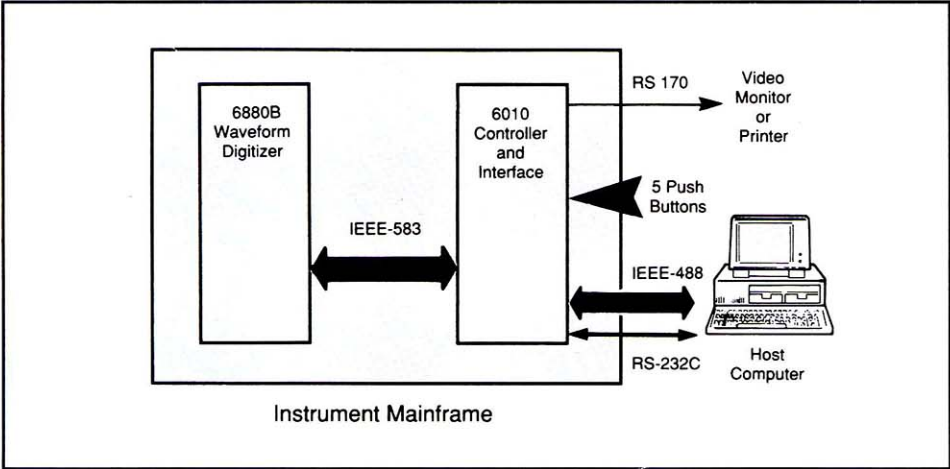

**SYSTEM ARCHITECTURE**

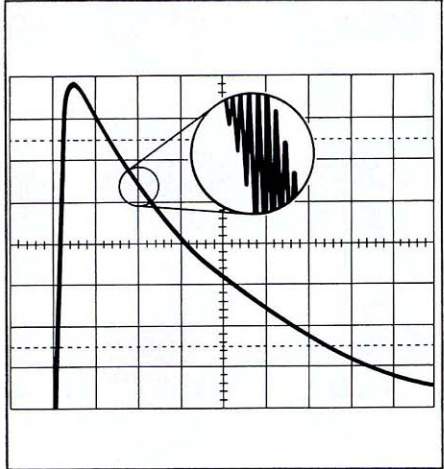

*The 6880B's 11-bit resolution detects details which other high-speed digitizers miss.*

resolution. In the 8-bit readout mode, the least significant digital output code resolves 2 mV; the 11-bit LSB resolves 250  $\mu$ V. Thus the 6880B detects even subtle details on large signals. Furthermore, the 6010 Interface contains digital filters which enhance the 6880B signal-to-noise ratio.

**DIGITAL FILTERS**

A wide range of filter selections permit the user to match the filter cutoff frequency to the highest signal frequency. For example, if the fastest risetime is known to be 2 nsec, which equates to

roughly 200 MHz bandwidth, then the 220 MHz digital filter will remove undesirable noise from the signal. These filters improve the already impressive 6880B accuracy (see the effective bits/signal-to-noise ratio charts in the specifications section).

**3 dB EXTRA HEADROOM**

Uniquely, the 6880B captures input signals even when they exceed the full scale input level. This extra headroom acts as a margin for unexpected input amplitudes. It lets the user anticipate 100% full scale inputs without concern for

lost data due to over-voltage clipping.

The 6880B digitizes 500 mV (full scale) signals with full accuracy. If the input is overloaded, the 6880B "soft clips" for 500 mV to roughly 700 mV inputs. The 6880B only truly clips the signal if it exceeds approximately 15% above or below the positive or negative full scale. In the soft clip range, the 6880B still captures the overall signal shape. This 3 dB extra headroom provides a critical benefit when recording rare transient events.

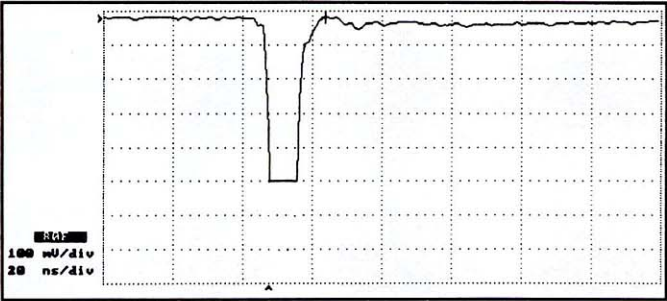

*The input signal clips at 500 mV (full scale) in the 8-bit mode.*

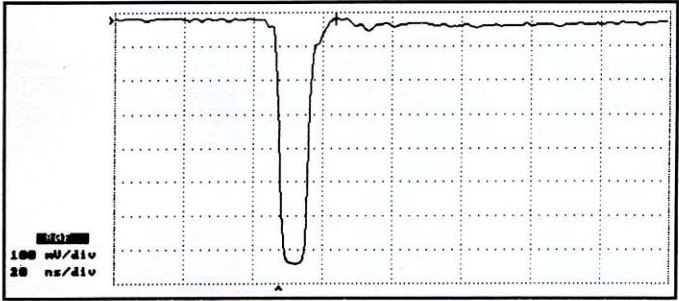

*In the 11-bit mode, the 6880B "soft clips" signals above or below full scale. Shown here, the signal shape is retained even though the amplitude is 770 mV p-p (i.e. beyond full scale).*



# Modular Digitizer Systems

## LONG RECORDING TIME

The 6880B Waveform Digitizer contains 10,016 sample points of battery backed up memory. At 1.35 GS/sec, this memory depth equates to 7.42  $\mu$ sec of recording time.

Several 6880B modules can be cascaded for longer recording time. Simultaneous trigger inputs synchronize the modules. The first 6880B records pre- and post-trigger data. The second 6880B records only after a user-programmed trigger delay. The third module uses additional delay, etc. The waveform data from each digitizer can be placed end to end for extended recording time.

## MULTIPLE CHANNEL RECORDING

The 6880B/6010 system design simplifies multi-channel applications. Each 6010 module can control up to six 6880B modules. A computer with a single GPIB port can control up to 84 6880B modules installed in 14 mainframes. LeCroy's PC-based Waveform Catalyst™ software supports simultaneous acquisition on 1 to 84 6880B modules from one computer.

The 6880B is fully compatible with all LeCroy Waveform Digitizers. The 6880B can operate side by side with any other LeCroy Waveform Digitizer or support module, including earlier version 6880 and 6880A Waveform Digitizers.

## MULTI-CHANNEL ACQUISITION INSURANCE

The ARMED and TRIGGERED outputs on the 6880B can be used to ensure data capture on every channel. For example, an engineer monitoring an experimental transient event with multiple 6880B channels can quickly check that all channels have armed

before initiating the event. With all the ARMED outputs tied together, the one composite ARMED output line changes state only if *all* channels have armed.

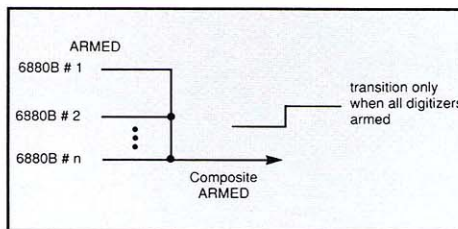

In similar fashion, the TRIGGERED output can be used to ensure all channels trigger before initiating an experimental transient event. The user triggers all the channels simultaneously. With all TRIGGER outputs tied together, the composite TRIGGER output will transition low-to-high only if all 6880Bs trigger. This composite TRIGGER output can be used to initiate the experimental transient event itself. The deep memory and programmable trigger delay ensure that 6880B digitizers capture the experimental transient event, even though it occurs some time after the trigger.

## SIGNAL AVERAGING

Averaging can remove random noise and improve resolution on repetitive signals. A single 6880B using 6910-EXE software provides up to 14 bits resolution and 72 dB of noise reduction through signal averaging.

6880B waveform averaging requires the optional 6910-EXE averaging software package, which runs in the 6010 interface. The software lets the user select either 100, 200, 500, or 1000 nsec waveform record length. The 6010 averages 100 nsec long waveforms at up to 300 waveforms/second, 1000 nsec waveforms at up to 100 waveforms/second.

## OPERATION

The user can fully configure the 6880B operating setup either manually or remotely. The setup parameters include trigger level, trigger slope, arm/trigger mode, trigger delay, input offset, input channel (A, B, or A+B summed), resolution (8 or 11 bits), active memory window, calibration mode, HF Boost (noise reduction factor), and filter.

## REMOTE/AUTOMATED OPERATION

All 6880B operating parameters are programmable. A host computer or terminal can download setup commands via either GPIB or RS-232C ports on the 6010 interface module. Waveform data can be read out across GPIB at up to 600 kbytes per second (DMA). The LeCroy GTALK utility lets a new GPIB programmer quickly familiarize himself with 6880B/6010 GPIB control codes and operation.

## MANUAL OPERATION

For transient capture, the 6880B can be operated manually. A user sets up the 6880B via four arrow buttons and one selection button located on the 6010 front panel. A monitor, driven by the 6010 composite video output, displays setup menus and an oscilloscope grid. The grid shows waveform traces from up to four 6880B digitizers.

The video output can also drive a video printer for local screen hardcopies. Or, LeCroy's PC utility, GTALK, lets the user print video waveforms using a low-cost PC printer ("SCREEN" command).



## AUTOMATIC CALIBRATION

The 6010 calibrates the 6880B upon command or at 10 minute intervals as selected by the user. The autocalibration results in unmatched system accuracy.

## BATTERY BACKUP

The 6880B contains battery backed memory for waveform data and calibration coefficients. After a 6880B has recorded a waveform, the module can be removed from the mainframe and later re-installed. Then the waveform data can

be read out through a 6010 just as though a power interruption had never occurred.

The 6010 stores the 6880B settings in battery backed up memory. Thus after power up, the 6880B will be configured in its last setup.

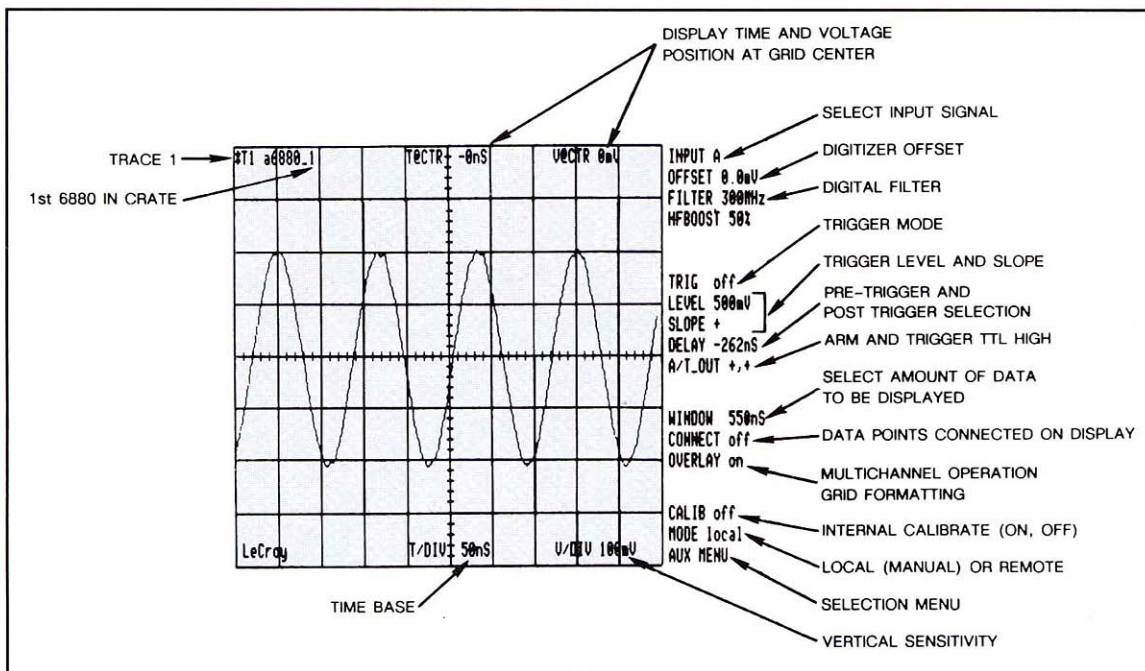

**MANUAL OPERATION:** A user can manually configure the 6880B operating setup via a control menu (shown above). A video monitor fed by the 6010 Video Out port displays the menu and 6880B waveforms.



# Modular Digitizer Systems

## 6880B Specifications

### ANALOG INPUTS

**Channels:** One, selected from INPUT A, INPUT B, A+B summed, or GND.  
**Connectors:** Two BNC type coaxial (INPUT A or B).  
**Input Isolation:** > 20 dB at 250 MHz between INPUT A and INPUT B.  
**Bandwidth:** 500 MHz typical.  
**Coupling:** DC.  
**Impedance:** 50  $\Omega$   $\pm$ 1% DC; 7% reflection max. from 1.0 nsec edge input signal.  
**DC Offset Voltage:** 0 to 0.5 V (Full Scale), programmable in 2.5 mV steps ( $\pm$ 2% accuracy).  
**Step Response:** < 1.5 nsec (10%-90%) with a 1 nsec input and no digital filter. Overshoot < 5% with calibration ON and 300 MHz filter.  
**Overload Protection:**  $\pm$ 2.5 V DC continuous;  $\pm$ 100 V for 100  $\mu$ sec ( $\geq$ 50  $\Omega$  source);  $\pm$ 20 V for 1 msec ( $\geq$ 50  $\Omega$  source).

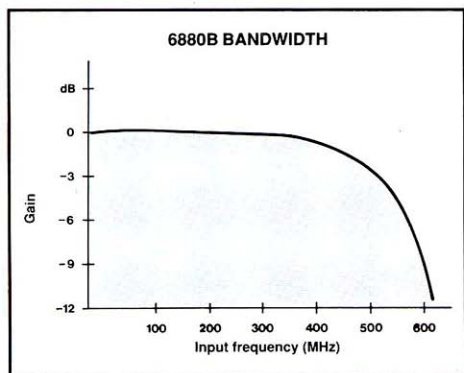

6880B Bandwidth

### ANALOG TO DIGITAL CONVERSION

**Single-Shot Resolution:** 8 bits (1 byte/sample) or 11 bits (2 bytes/sample); 2's complement integer data.

**11-bit mode Enhances Resolution and Provides "Soft Clipping":**

Signal Input	11-bit Mode Output Codes*	8-bit Mode Output Codes
+350 mV	2400 decimal	255 decimal
+250 mV (+FS)	2000 decimal	250 decimal
0 mV	1000 decimal	125 decimal
-250 mV (-FS)	0 decimal	0 decimal
-350 mV	-400 decimal	0 decimal

\* PC-based Waveform-Catalyst (Model 6900) software offsets 11-bit data by 1000 decimal to vertically center waveform displays.

**Repetitive Resolution:** Up to 14 bits for averaged signals.  
**Sample rate:** 1.348 gigasamples/sec fixed.  
**Sample interval:** 742 psec.  
**Time Base Accuracy:** 0.01%, crystal controlled.  
**Aperture Uncertainty:** 5 psec.  
**DC Accuracy:** 1% typical.  
**DC Noise:** < 2 counts rms (8-bit mode, 300 MHz filter).  
**AC Accuracy:** A digitized pure sine wave (11-bit mode) has a typical dynamic accuracy as shown below.

Signal Freq.	Filter Freq.	10% Full Scale Input		80% Full Scale Input	
		Effective Bits	SNR*	Effective Bits	SNR*
10 MHz	10 MHz	9.7	60 dB	9.4	56 dB
20 MHz	20 MHz	9.4	58 dB	8.2	49 dB
50 MHz	50 MHz	8.4	52 dB	7.4	45 dB
100 MHz	100 MHz	8.0	50 dB	6.8	42 dB
200 MHz	220 MHz	6.9	43 dB	6.0	37 dB
400 MHz	400 MHz	6.3	40 dB	4.8	30 dB

\* Effective Bits and Signal-to-Noise Ratio (SNR) figures include all harmonics.

### TRIGGERING

**Source:** External or software command.  
**Mode:** Normal, Single, Auto (every 3 seconds), Off.  
**Input Impedance:** 1 k $\Omega$ //10 pF.  
**Coupling:** DC.  
**Slope:** +, - .  
**Level:** Programmable over  $\pm$ 2.5 V in 20 mV steps.  
**Minimum Signal Required:** 30 mV.  
**Accuracy:**  $\pm$ 15 mV.  
**Minimum Trigger Width:** 10 nsec duration.  
**Triggering Error:**  $\pm$ 0.5 sample ambiguity in trigger position (using pulse with 1 nsec risetime, 50 mV overdrive).  
**Overload Protection:**  $\pm$ 250 V transients for 0.5  $\mu$ sec.

### WAVEFORM MEMORY

**Internal:** 10,016 samples, non-expandable.  
**Pre-/Post Trigger Range:** 7.4  $\mu$ sec pre-trigger to 1.55 msec post-trigger; variable in 23.74 nsec (32 sample) steps.  
**Readout:** 1 sample to 10,016 samples max. (calibrated data).

### FILTERS

**Type:** Digital FIR (no anti-aliasing effect).  
**Low Pass:** 10 MHz, 20 MHz, 50 MHz, 100 MHz, 150 MHz, 200 MHz, 220 MHz, 270 MHz, 300 MHz, 400 MHz, or NONE.

### WAVEFORM AVERAGING

**Averaging Rate:** 300 waveforms/sec max. (100 nsec window).



**Waveform Windows:** Selectable 100 nsec, 200 nsec, 500 nsec, or 1000 nsec.

**Number of 6880Bs:** One only.

**Max Number of Sweeps:** 1,048,576.

**Software Required:** 6910-EXE downloadable 6010 program.

## MANUAL OPERATION

**6010 Control Buttons:** Five, for controlling 6880B setup menus (6010 Video Out).

**6880B SELECT Button:** When displaying several 6880B waveforms on one monitor (6010 Video Out), identifies 6880B module vs. display trace and shows setup.

## GPIB (IEEE-488)

See the LeCroy 6010 data sheet for details.

## SERIAL INTERFACES

See the LeCroy 6010 data sheet for details.

## FRONT PANEL OUTPUTS

**Armed:** TTL open collector output; selectable as either TTL high (2.5 to 5.0 V) or low (0 to 0.5 V) when armed.

**Triggered:** TTL open collector output; selectable as either TTL high (2.5 to 5.0 V) or low (0 to 0.5 V) when triggered by TRIGGER input or software command.

**Offset and Level Testpoints:** Allow manual check of offset and trigger level with DC voltmeter.

**6010 Video Output:** 8-bit oscilloscope display, expandable from 1000 nsec/div to 1 nsec/div., plus setup menus.

## STATUS INDICATORS

**Power:** Lit when +6 V, -6 V, +24 V, and -24 V all present.

**Input A:** Lit in "INPUT A" or "INPUT A + B" mode.

**Input B:** Lit in "INPUT B" or "INPUT A + B" mode.

**Reference:** Lit in "REF" mode.

**Slope:** Lit when trigger slope set to positive.

**Armed:** Lit when 6880B is armed, digitizing, and waiting for a trigger.

**Triggered:** Lit after receiving a trigger and until re-armed.

## INTERNAL BATTERY

**Type:** Replaceable lithium battery.

**Lifetime:** > 2 years.

**Function:** Automatically becomes power source for calibration coefficients and waveform memory when line power fails (6880B settings are battery backed up in the 6010).

## POWER REQUIREMENTS

Model	+6V	-6V	+24V	-24V
6880B	2.75A	6.0A	0.8A	0.9A
6010/6010A	0.5A	0.1A	0.2A	0.1A

**Operating Temperature:** +10° to +30° C intake air with sufficient airflow to limit exhaust air to 40°C maximum.

**Storage Temperature:** -10° to +50° C.

**Temperature Monitor:** Sensor in the 6880B allows remote readout of module temperature  $\pm 5^\circ$  C.

**Operating Humidity:** Up to 95% relative humidity non-condensing at +25° C.

**Operating Altitude:** 0 to 15,000 feet above sea level.

## PACKAGING

RF shielded module in conformance with IEEE-583 Standard (CAMAC). (See table below.)

Model	Size	Height	Width	Depth	Weight
6880B	#3	221 mm	51 mm	292 mm	1.9 kg
6010/6010A	#3	221 mm	51 mm	292 mm	1.8 kg

## ORDERING INFORMATION

6880B 1.35 GS/sec Waveform Digitizer

6910-EXE 6010 software for high-speed 6880B waveform averaging (5 1/4" high-density MS-DOS diskette with download routine for PCs). Includes GTALK.

GTALK PC utility (low density 5 1/4" diskette) for receiving data across GPIB to any GPIB device. Requires an IBM PC or equivalent with National Instruments PC2, PC2A, or PC3 GPIB Interface installed.



# TR8818A/TR8828D Digitizers & MM8103A/04/05/06 Memories

## Main Features

- Excellent accuracy (up to 7.4 effective bits)
- >120 MHz bandwidth
- High-speed signal averaging
- Up to 98 channels per GPIB port
- Waveform records to 640 megasamples
- Remote programmability

## General

LeCroy Models TR8818A and TR8828D Waveform Digitizer modules provide the system core for high-speed, long record, waveform recording. The proven, ultra-accurate system delivers unmatched data fidelity. The TR8828D digitizes up to 200 megasamples/second, the TR8818A up to 100 MS/sec.

The modular system design equates to configuration flexibility and low expansion costs. A minimum system contains one channel. To simultaneously measure multiple waveforms, add more TR8818A or TR8828D digitizer modules to your system. To look at longer waveforms, add more memory modules to existing channels. Whether it's next month or five years from now, add another module, not another system.

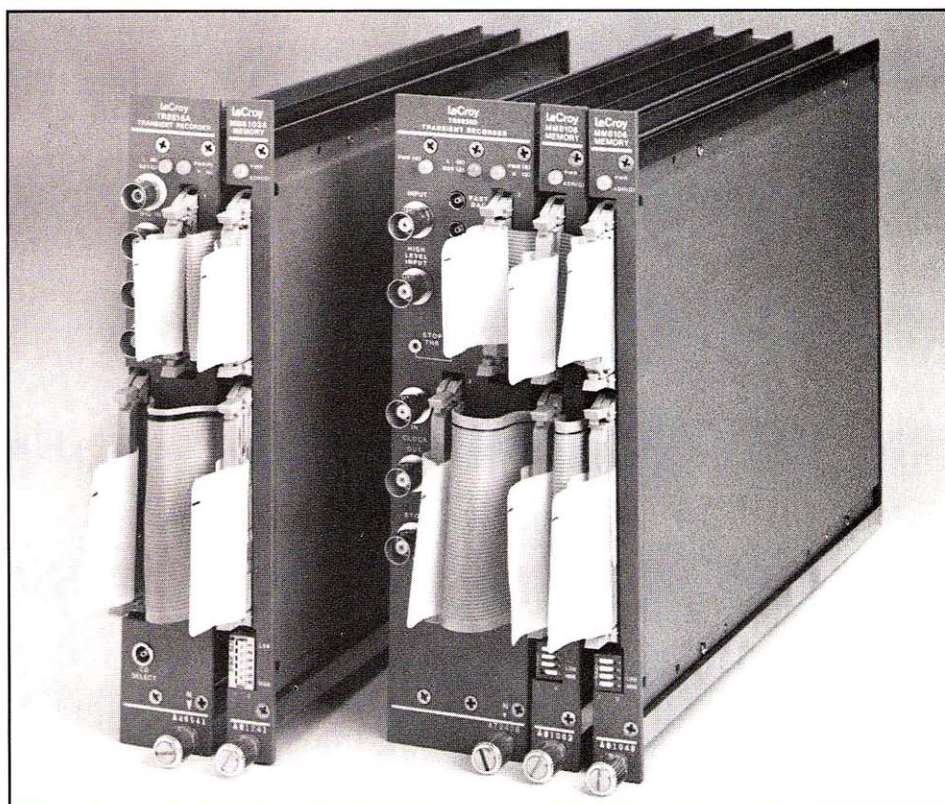

## SYSTEM ARCHITECTURE

A complete waveform digitizing system includes one or more waveform digitizing modules, one or more waveform memory modules per digitizer module, an interface module, an instrument mainframe, a GPIB or RS-232C cable, and a host computer. A minimum configuration, single channel TR8828D (TR8818A) system uses one MM8104 (MM8103A) Memory Module for 32 ksamples of waveform storage memory.

Multiple digitizer modules can reside within a single mainframe. TR8828D modules can be mixed with TR8818A modules or any other IEEE-585 Standard (CAMAC) instrument modules.

A 6103 pre-amplifier module mates with either the TR8818A or TR8828D Waveform Digitizers for optimal system performance. The 6103 attenuates or amplifies 50 mV to 50 V full scale inputs to match the digitizer's full scale input. Without the 6103, the TR8828D and TR8818A full scale inputs are 510 mV.



The TR8828D also contains a second, attenuated, parallel input (High Level Input) of 5.10 V full scale.

## MULTICHANNEL DATA ACQUISITION

The modular design simplifies multiple channel applications. Note the large number of channels available:

	TR8828D/ MM8104	TR8818A/ MM8103A
Per benchtop	2	3
Per chassis	5	7
Per GPIB system	70	98

Each digitizer module contains its own internal timebase. The external clock input (front panel) allows a TTL or ECL level signal (jumper selectable on TR8818A; ECL only on TR8828D) to determine the sampling frequency. This external clock is used to synchronize multiple channels to a user-supplied master clock. The frequency of the external clock can range from DC to 200 MHz for the TR8828D, and DC to 100 MHz for the TR8818A.

The TR8828D also contains front-panel ARM BUSY and TRIG BUSY outputs for multichannel acquisition verification. The ARM BUSY output will not change state (selectable polarity) until the digitizer has been armed. The TRIG BUSY will not change state unless the digitizer has been triggered. For multiple channel applications, all the modules' ARM BUSY lines (open collector) can be tied together. The ARM BUSY node will not change state unless all modules are

armed. By monitoring this node, the test operator can ensure an acquisition on every digitizer channel. The TRIG BUSY outputs can also be tied in similar fashion.

## LONG RECORDING TIME

Long waveform memory lets the TR8818A and TR8828D record long waveforms even at fast sample rates. No need to reduce the timebase (sampling rate) to capture entire waveforms.

The TR8818A requires at least one memory module (MM8103A, MM8105, MM8106). Each MM8103A offers 32K samples of memory, each MM8105 offers 128K samples, and each MM8106 512K samples. Additional same type memory modules can be added as needs arise to expand the total usable waveform memory up to 2 M samples max.

The TR8828D requires at least one pair of MM8103A, MM8105, or MM8106 memory modules or one MM8104 memory module. Additional pairs of same type memory modules can be added to expand total waveform memory up to 2M samples max. The MM8104, a 32K sample module, provides a cost-effective solution for small memory requirements. The MM8104 can be reconfigured (jumpers) to be an MM8103A module for expansion purposes. Otherwise only one MM8104 is allowed per TR8828D. The MM8103A, MM8104, MM8105, and MM8106 all save waveform data through power

failures. Memory is only cleared of previous data when the digitizer is armed for a new acquisition.

For applications requiring more than 2M samples of memory, the LeCroy 6309/6389 Snapshot memory system offers 16M samples of memory (single configuration). Each channel of Snapshot memory fits into 17 slots of a rackmount CAMAC instrument mainframe.

For applications requiring more than 16M samples of memory the LeCroy 7900 Series WaveCorder system offers up to 640M samples of memory, providing over 3 seconds of continuous recording at a full 200 MS/s sampling rate! The system can also be used as a long memory arbitrary function generator by playing back recorded signals. See 7900 Series data later in this section.

## SEGMENTING MEMORY FOR MULTIPLE SIGNAL BURSTS

In segmented memory operation, the TR8818A and TR8828D accept very fast trigger repetition rates. When a digitizing system reads out data, its trigger is disabled and it cannot capture waveforms. Segmenting waveform memory into subsections allows the digitizing system to record multiple waveforms without stopping to read out the data. So, segmented memory helps to ensure capture of closely spaced signals. It also prevents recording uninteresting deadtime between signals and thereby saves memory.



# Modular Digitizer Systems

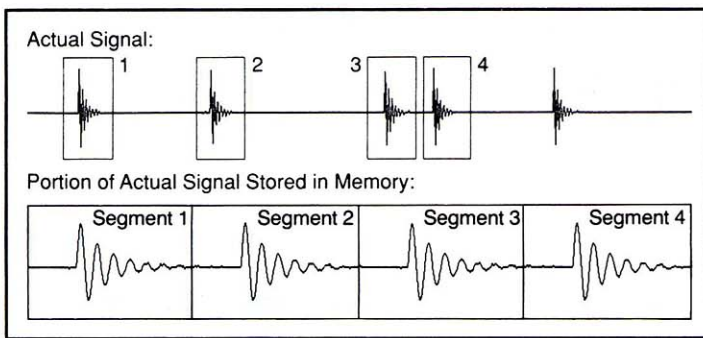

Burst Mode Operation

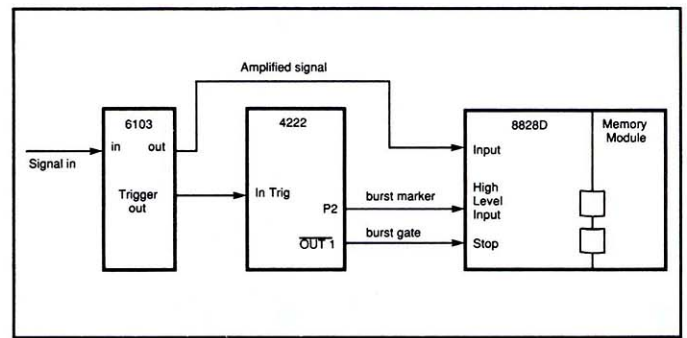

Burst Mode Block Diagram

The TR8828D segments memory via an internal "burst" mode. The selected TR8828D burst mode uses a LeCroy 4222 gate and marker. The gate determines the recording time after receipt of a new trigger (each segment has its own trigger, post trigger recording only). The TR8828D burst mode catches every pulse, even at a 20,000 pulse per second rate. After the memory is filled, all the waveforms can be read out as a data block.

Both the TR8828D and TR8818A can fill waveform memory in segments by starting and stopping an external clock in conjunction with signal presence. A LeCroy 2323A Gate Generator module can gate an external clock for this purpose. A trigger signal starts the clock gate. A programmed delay stops the clock. After data has been clocked into

every active memory location, then all the waveforms can be read out as a data block.

The TR8828D and TR8818A offer segmented memory operation with both the MM810X Series Memory Modules and the 16 Msample Wide Window memory system. The ultra-long WaveCorder memory can also be segmented, but with a single programmable length for all segments (10,240 samples min.). WaveCorder memory allows for pretriggered recording in each segment.

## FULLY PROGRAMMABLE, EASY SETUP

The TR8828D and TR8818A digitizer modules, and 6103 amplifier module are all fully programmable for automated testing, remote operation, and quick

setups. Remote commands set the digitizers' sample clock rate, pre-trigger memory fraction, waveform record size, and input offset. Remote commands can also arm and trigger the digitizers. A Look-At-Me flag gets set when data is ready for readout. Look-At-Me (LAM) gets translated to a GPIB Service Request (SRQ) by the LeCroy 8901A or 6010 Interface module for GPIB readout.

A digital-to-analog converter (DAC) output assists setup of the TR8828D digitizer. As soon as the TR8828D digitizes the input, it converts it back to an analog signal. By monitoring the output with an analog oscilloscope, excessively small or clipped input signals can be detected. Thus it helps to quickly adjust TR8828D offset and 6103 amplifier gain.



## TR8818A/TR8828D Specifications

Unless otherwise stated, the specifications apply to both the TR8818A and TR8828D Waveform Digitizers.

### ANALOG INPUT

**Channels:** One (INPUT and HIGH LEVEL INPUT summed internally on the TR8828D).

**Connector:** BNC type coaxial.

**Impedance:** 50 Ohms  $\pm 3\%$  DC;  $< 7\%$  reflection from 3 ns edge.

**Bandwidth:** DC to  $> 120$  MHz guaranteed.

### TYPICAL TR8828D ANALOG BANDWIDTH

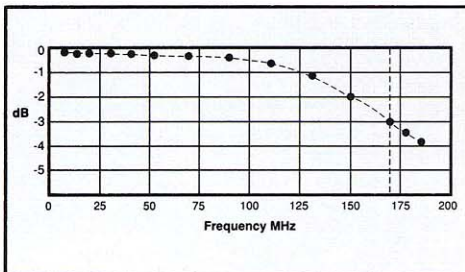

**DC Offset Voltage:** Programmable over  $\pm 1/2$  full scale in 256 steps;  $\pm 0.1\%$  full scale/ $^{\circ}\text{C}$ .

**Coupling:** DC.

**Overshoot:**  $< 5\%$  typical for step input with or without 6103 amplifier.

**Overload Recovery:**  $\pm 1\%$  F.S. in 25 ns from a 1.5X overdrive pulse of  $< 1$   $\mu\text{sec}$  duration.

**Overload Protection:**  $\pm 2.5$  VDC INPUT,  $\pm 7.5$  VDC HIGH LEVEL INPUT;  $\pm 500$  Vpk for 30 ns;  $\pm 100$  Vpk for 100  $\mu\text{s}$  with 50 Ohms source.

### ANALOG TO DIGITAL CONVERSION

**INPUT Amplitude Range:** 510 mV p-p (2 mV/LSB)  $\pm 1\%$  F.S.  $\pm 0.1\%/^{\circ}\text{C}$ .

**High Level Input Amplitude Range (8828D only):** 5.1 V p-p (20 mV/LSB)  $\pm 2\%$  F.S.  $\pm 0.1\%/^{\circ}\text{C}$ .

**Single Shot Resolution:** 8 bit (offset binary code).

**DC Accuracy:** Errors  $< \pm 1.5$  LSB + 0.5 LSB quantization error from best linear fit over entire range.

**TR8828D AC Accuracy:** A reconstructed digitized pure sine wave has a typical dynamic accuracy as follows:

Signal Frequency	Signal Amplitude	Effective Bits	Non-harmonic Effective Bits	Signal-to-Noise Ratio (SNR)*
DC-5 MHz	80% F.S.	7.3	7.6	46 dB
5-20 MHz	80% F.S.	7.0	7.5	43 dB
20-50 MHz	50% F.S.	6.4	7.4	39 dB
50-100 MHz	50% F.S.	5.9	7.0	37 dB

\* Signal-to-Noise Ratio includes all harmonics.

**TR8818A AC Accuracy:** A reconstructed digitized pure sine wave has a typical dynamic accuracy as follows:

Signal Frequency	Signal Amplitude	Effective Bits	Signal-to-Noise Ratio (SNR)*
DC-5 MHz	80% F.S.	7.2	47 dB
5-20 MHz	80% F.S.	7.0	45 dB
20-25 MHz	50% F.S.	7.2	41 dB
25-50 MHz	50% F.S.	6.9	41 dB

\* Signal-to-Noise Ratio includes all harmonics.

**Aperture Uncertainty:**  $\pm 5$  ps maximum.  
**Noise:**  $< 1.7$  LSB rms.

### TIMEBASE

**Internal sample clock rates:** 200 (TR8828D only), 100, 50, 25, 12.5, 6.25, 3.125, or 1.5625 (8818A only) MS/sec.

**Accuracy:** 0.01% crystal oscillator.

**TR8828D External Clock:** Any frequency input up to 200 MHz; ECL level input terminated to either GND or -2 VDC, 50 Ohm input.

**TR8818A External Clock:** Any frequency input up to 100 MHz; TTL or ECL levels 50 Ohm input.

**Clock Out:** ECL level.

### TR8828D STOP TRIGGER

**Slope:** + or - (set on side panel).

**Level:** Variable from -2V to +2V; adjusted and monitored from front panel.

**Impedance:** 50 Ohms  $\pm 3\%$ .

**Duration:** 8 nsec minimum.

**Overload Protection:**  $\pm 2.5$  VDC;  $\pm 250$  Vpk for 1  $\mu\text{sec}$  with  $\geq 50$  Ohm source.

**Normal Operation:** A trigger switches the TR8828D from pre- to post-trigger recording; digitizing stops when post-trigger sampling complete.

**Burst Operation:** Gate signal at STOP input enables waveform memory clock to segment memory.

### TR8818A STOP TRIGGER

**Slope:** + only.

**Level:** TTL (+2.5 V) or ECL (-1.2 V).

**Impedance:** 50 Ohms  $\pm 3\%$ .

**Duration:** 8 nsec minimum.

**Overload Protection:**  $\pm 2.5$  VDC;  $\pm 250$  Vpk for 1  $\mu\text{sec}$  with  $\geq 50$  Ohm source.

**Operation:** A trigger switches the TR8818A from pre- to post-trigger recording; digitizing stops when post-trigger sampling complete.



# Modular Digitizer Systems

## WAVEFORM MEMORY Memory Configurations

Standard Memory Configurations for TR8828D				
Total Memory Length (samples)	MM8103A* quantity	MM8104 quantity	MM8105 quantity	MM8106 quantity
32k	-	1	-	-
64k	2	-	-	-
128k	4	-	-	-
192k	6	-	-	-
256k	8	-	2	-
320k	10	-	-	-
384k	12	-	-	-
448k	14	-	-	-
512k	16	-	4	-
768k	-	-	6	-
1024k	-	-	8	2
1280k	-	-	10	-
1536k	-	-	12	-
1792k	-	-	14	-
2048k	-	-	16	4

\*The MM8104 can be configured as an MM8103. Thus, systems with MM8104s can be expanded with MM8103As.

**Active Memory Size:** Programmable in 8 KS/s increments for TR8818A, in 16 KS/s increments in TR8828D, up to the total installed memory size (max. 2 MS/s).

**Pre-trigger:** Memory can be divided into pre- and post-trigger sample storage; programmable from 0% to 100%, in 1/8ths of total memory.

**Burst Mode (TR8828D only):** Allows STOP trigger input to double as memory clock control gate to make efficient use of memory; side-panel jumper configured; pre-trigger and programmed stop features not usable.

**Battery Backup:** Data in memory preserved when external power removed.

### Cables Required:

DC8134/N Digitizer-to-memory address cable (N=# of memory modules). DC8150/N

Standard Memory Configurations for TR8818A					
Total Memory Length (samples)	MM8103A quantity	OR	MM8105 quantity	OR	MM8106 quantity
32k	1	-	-	-	-
64k	2	-	-	-	-
96k	3	-	-	-	-
128k	4	1	-	-	-
160k	5	-	-	-	-
192k	6	-	-	-	-
224k	7	-	-	-	-
256k	8	2	-	-	-
288k	9	-	-	-	-
320k	10	-	-	-	-
352k	11	-	-	-	-
384k	12	3	-	-	-
416k	13	-	-	-	-
448k	14	-	-	-	-
480k	15	-	-	-	-
512k	16	4	-	1	-
640k	-	5	-	-	-
768k	-	6	-	-	-
896k	-	7	-	-	-
1024k	-	8	-	2	-
1152k	-	9	-	-	-
1280k	-	10	-	-	-
1408k	-	11	-	-	-
1536k	-	12	-	3	-
1664k	-	13	-	-	-
1792k	-	14	-	-	-
1920k	-	15	-	-	-
2048k	-	16	-	4	-

Digitizer-to-memory data cable (N=# of memory modules).

## GENERAL

### Status Indicators:

**Power (red)** - all supplies operating properly.

**N (green)** - controller sent command to the digitizer module (slot N).

**LAM (red)** - waveform acquisition complete.

**RDY (green)** - armed and ready for trigger.

**Module ID:** 8-bit side-panel switch allows user to assign a unique ID number; readable via CAMAC/GPIB.

**Internal Battery:** Replaceable lithium type (lifetime > 2 years) in each digitizer and memory module automatically becomes power source for memory and control registers.

## MECHANICAL

**Packaging:** RF shielded module in conformance with the IEEE-583/CAMAC.

Module	Size	Height	Width	Depth
TR8818A	2 slots	221mm	34mm	292mm
TR8828D	3 slots	221mm	51mm	292mm
MM810x	1 slot	221mm	17mm	292mm

## Power Requirements:

Module	+6 V	-6 V	+24 V	-24 V
TR8818A	0.44 A	7.8 A	.22 A	.14 A
TR8828D	0.775 A	6.0 A	.22 A	.175 A
MM8103A	2.5 A	1.3 A	-	-
MM8104	2.5 A	1.3 A	-	-
MM8105	2.7 A	1.3 A	-	-
MM8106	2.9 A	2.1 A	-	-

## ENVIRONMENTAL

**Operating Temperature:** +15 to +25 °C intake air with sufficient airflow to maintain exhaust air less than 15 °C higher than intake; up to 30 °C if exhaust <40 °C.

**Storage Temperature:** -10 to +50 °C.

**Operating Humidity:** Up to 90% r.h. non-condensing at +25 °C.

**Operating Altitude:** <10,000 feet above sea level.



## 6389/6309 Snapshot™ Recorder

---

### Main Features

**16 M Sample Storage** for LeCroy's Model TR8828D and TR8818A high speed digitizers provides the capability for saving very long records without sacrificing fine detail.

**Expandable Memory** - Serially cascading several 16M memories provides even larger memory depth.

**Multiburst Capture** - Burst mode feature (TR8828D only) causes memory to accept data only when enabled and can be used to store many non-sequential waveforms of arbitrary length.

**Pre-trigger and Post-trigger Information** - 32k samples of data memory may be allocated to record the waveform prior to the occurrence of the trigger.

**Serial Port** - Allows use of memory for storing serial 1, 2, 4, or 8-bit data streams from a user source.

**Fully Programmable** - System can be externally controlled for automatic or remote setup.

**Extended Timebase** - Sample rates can be set much slower (to 12 ksamples per second) than normally allowed with the standard digitizers (LeCroy TR8818A and TR8828D).

**Typical Applications Include** RADAR, ELINT/COMINT, TEMPEST, SONAR, ultrasound, image processing, DRFM, data storage research.

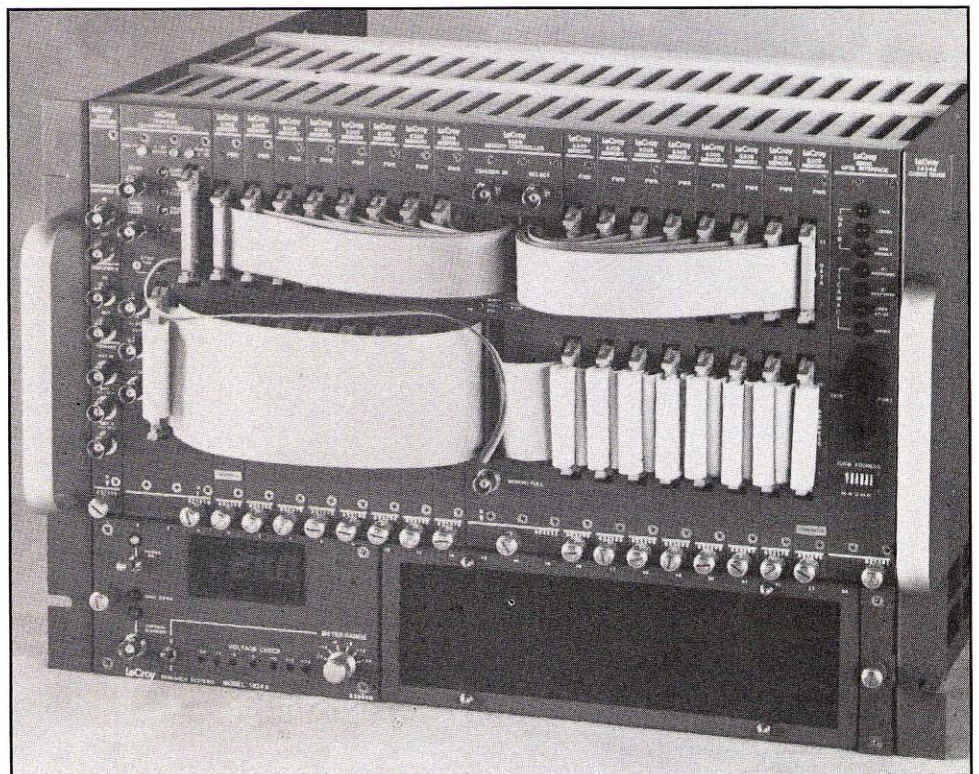

### Functional Description

The LeCroy 6389/6309 Snapshot Recorder provides the capability of saving long records without sacrificing fine detail.

The 6389 memory controller accepts data from LeCroy Models TR8828D and TR8818A high speed plug-in digitizers or from an 8-bit serial port and stores it in sixteen 6309 one megasample memory modules. For applications requiring even more memory, multiple systems of 16

Msample memories can be serially cascaded together. The Snapshot Recorder fits within a single Model 8025 or 1434A rackmount chassis and uses a standard Model 8901A or 6010 interface.

The digitizer port operates in one of two modes depending on the data rate. In the Fast Mode, the rate is set directly by the digitizer (selectable rates of 200 MS/sec to 3.1 MS/sec) with data from it stored directly into memory. In the Slow Mode, the 6389 divides the clock by dropping data to effectively reduce the



---

## Modular Digitizer Systems

---

sample rate. The effective sample rate can be set in binary increments from a minimum of 12 kS/sec to a maximum of 1.6 MS/sec. When the digitizer port is in use, the serial port is disabled.

The serial port is programmable to accept either 1, 2, 4, or 8-bit serial data at a rate determined by the user's serial port clock to a maximum of 25 MHz. When the serial port is in use, the digitizer port is disabled.

The Model 6389 Memory Controller initiates system triggering (the Digitizer is started under program control and left in a continuous digitizing state). When set

in post-trigger mode, a trigger causes continuous data storage until the active memory is full.

The 6389 also operates in a pretrigger and in a burst mode. Burst mode allows capture of thousands of pulses, intermittent transmissions, or other low duty cycle signals. The trigger input is level sensitive (high-level enables storing of data and a low level disables storing) until memory is full.

Pretrigger mode is the same as post-trigger mode except the first 32 ksamples of memory store pretrigger data. As soon as the 6389 is armed,

data is continuously written to this pretrigger section of memory (wrap-around). A trigger causes post-trigger data to fill the rest of the memory. The active memory size can be set to 1, 2, 4, 8, or 16 megabytes.

For applications requiring even more memory, cascade 16 Msample systems together using the Memory Full Flag output as the trigger for each additional system. Note that each additional system requires a digitizer and an input signal splitter to each digitizer.



## 6309/6389 Specifications

### 6389 MEMORY CONTROLLER

The Model 6389 controls a TR8818A or TR8828D Waveform Digitizer and 16 Model 6309 Memory Modules. Programmable commands allow the user to arm and trigger the system, set active memory size and sampling rate, and provide memory and address increments for block data transfer.

### DIGITIZER PORT

**Data Size and Format:** 32 bit; single-ended ECL

**Write Rate:** DC to 50 MHz

**Termination:** 100  $\Omega$  to -2.5 V

### SERIAL PORT

**Data Size and Format:** 1, 2, 4, or 8 bit; single-ended ECL

**Write Rate:** DC to 25 MHz

**Termination:** 100  $\Omega$  to -2.5 V

### TRIGGER

**Slope:** + only

**Level:** TTL compatible

**Impedance:** 1 M $\Omega$

**Duration:** 50 nsec min

**Overload Protection:**  $\pm$  250 V DC indefinite

**Modes:** The instrument can operate in one of three trigger modes selectable via a front-panel switch: 1) Pretrigger, 2) Post-trigger or

3) Burst. In Pretrigger Mode a fixed 32 KB of the total memory size is set aside as pretrigger memory. In Post-trigger Mode, data storage occurs after the trigger occurs. In Burst Mode, the trigger signal gates data storage.

### CONNECTOR DESCRIPTIONS

**Memory Full Output:** Positive slope nominally 0 to +3 V; TTL compatible; will drive 50  $\Omega$  load; compatible with TRIGGER IN to allow system cascading.

**Select Input:** The Select Input functions as a module identification port and can be used in conjunction with the LeCroy Model 6399 Test and Display Module in applications requiring guaranteed system performance and real-time display.

### 6309 Memory

**Memory Size:** 1 megabyte organized as 512k X 16-bit words

**Write Rate:** 12.5 megabytes/sec (6.25 Mwords/sec) maximum

**Read Rate:** 2 megabytes/sec (1 Mword/sec) maximum

**Battery Backup:** Recorded data preserved through power failures

POWER REQUIREMENTS		
	+6 V	-6 V
Model 6389	1.1 A	1 A
Model 6309	2.8 A	-

### ENVIRONMENT

**Operating Temperature:** Proper operating temperature required +15° C to +25° C intake air with sufficient air flow to maintain temperature of exhaust air to < 50° C.

**Operating Humidity:** Up to 90% relative humidity non-condensing at +25° C.

**Operating Altitude:** Up to 8,000 feet above sea level (2437 m).

**Non-operating Storage Temperature:** -10° C to + 50° C

### PACKAGING

RF-shielded module in conformance with the CAMAC (IEEE-583) standard

	SIZE	HEIGHT	WIDTH	DEPTH
Model 6389	#3	221 mm	34 mm	292 mm
Model 6309	#1	221 mm	17 mm	292 mm



# 7900 Wavecorder™ System

### Main Features

- **High Speed Long Memory:** 10 to 640 megasamples of waveform memory for capturing/replaying data at rates up to 200 megasamples/sec.
- **High Resolution:** 8 bits, 100 MHz analog bandwidth or 12 bits, 2.5 MHz bandwidth.
- **Memory Segmentation:** Any portion of memory may be selected for data capture or replay.
- **Host Specific Interfacing:** Support for VAX™/MicroVAX™, SUN™/VME, and IBM-AT hosts.
- **Host-Specific Software:** Interactive commands and function libraries allow the user to both operate the 7900 system and develop application specific software in a familiar environment.
- **Real-Time Replay:** Either captured or simulated data may be played at rates up to 200 megasamples/sec.
- **Expandable Memory:** Systems starting with 10, 40, or 160 megasamples can be easily expanded up to 40, 160, or 640 megasamples of memory, respectively.
- **Well-established Front Ends:** Systems may be configured with one or two channels of LeCroy's popular TR8828D or 6810 digitizers.

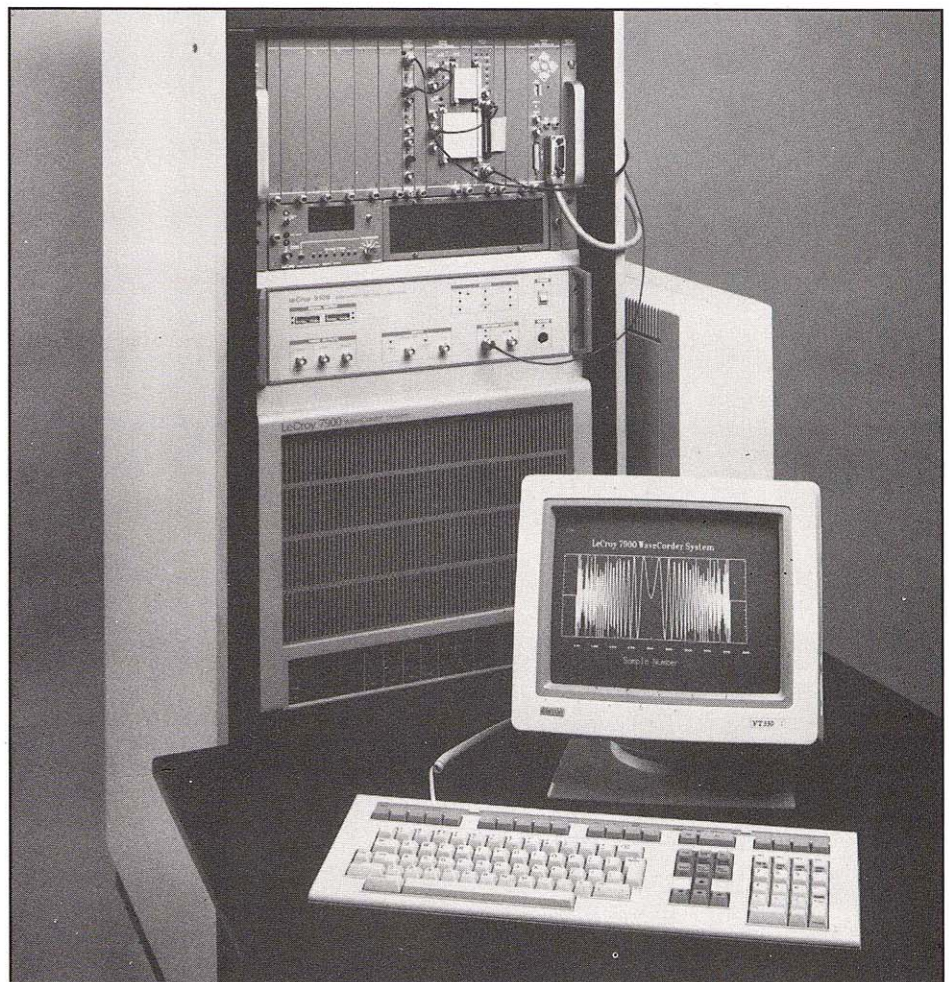

- **Flexible Output Signal Conditioning:** The optional playback DAC unit is based on the LeCroy 9109 Arbitrary Function Generator which provides programmable full scale voltage, offset voltage, and output filtering.
- **Flexible Single-Shot Capture/Replay:** Up to 80 gigasamples of post-trigger and/or trigger-holdoff counting available for capture/replay, which includes support for up to 100% pre-trigger recording.



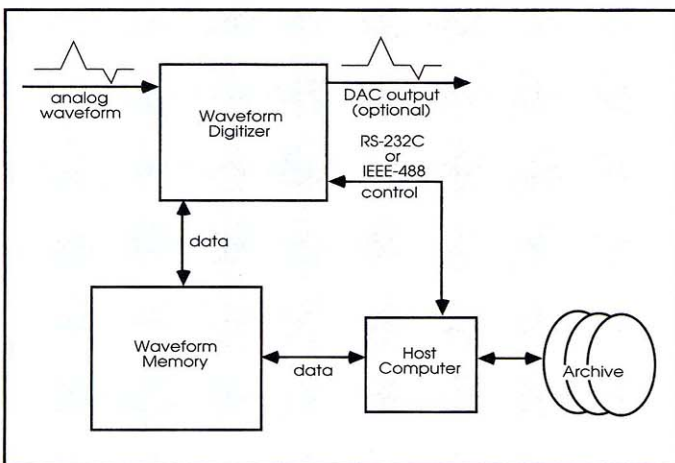

System Block Diagram

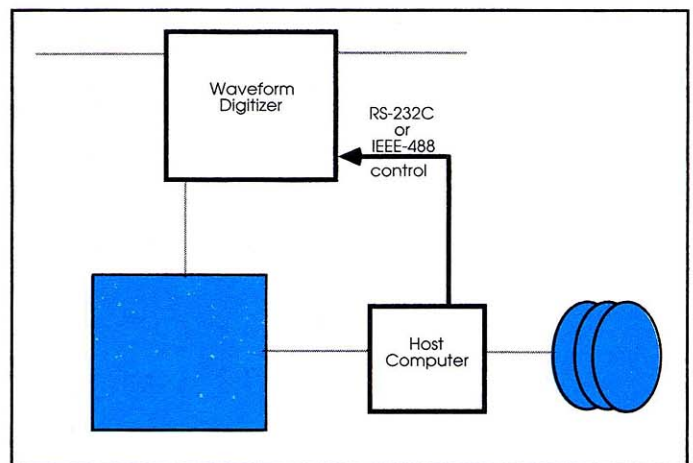

Initialize and Arm Digitizer

## General

The LeCroy 7900 WaveCorder System is a digital waveform recording and playback system designed for long, fast waveforms. The WaveCorder can capture (or replay) over 3 seconds of continuous waveforms digitized at 200 megasamples/sec (8-bit samples).

The WaveCorder System consists of a waveform digitizing system, a fast waveform memory system, an optional waveform output unit (D/A), and hardware as well as software interfacing for a (user supplied) host computer. Both system control and long-term storage of waveform data are provided by the host computer.

The waveform digitizing system converts analog waveform inputs into 8-bit digital samples at a selectable sample rate. The system directs the digital data into a large block of memory in real time. Dual channel operation can be implemented.

Any portion (>20 kBytes) of the installed memory may appear as a seamless circular buffer. The WaveCorder records/plays continuously, overwriting/replaying data in this buffer. Based on user-selected trigger holdoff and post-trigger settings, data recording/playback is stopped upon a hardware or software trigger signal.

Simulated or previously acquired data can be downloaded from the host to the waveform memory for playback through an optional DAC unit.

Both software function libraries and interactive command sets are available for a variety of Host systems.

### WAVEFORM DIGITIZER

The waveform digitizing subsystem includes one or more pre-amplifiers/attenuators and waveform digitizing modules and a RS-232C/IEEE-488 Standard Interface module. An IEEE-583 Standard instrument mainframe houses all these modules. The digitizing

system is fully programmable: Commands sent via RS-232C or IEEE-488 program the input signal amplitude range, trigger level, digitizer sample rate and arm the system.

### WAVEFORM MEMORY

The fast storage, waveform memory system consists of a Model 7900 mainframe and expandable memory modules. Memory can be configured using three types (sizes) of memory blocks, 10, 40 or 160 megasample blocks which cannot be mixed. Therefore, a memory mainframe system based on 10 megasample blocks can only be configured into 10, 20 or 30 megasample systems. A system based on 160 megasample blocks can be configured into 160, 320, 480 or 640 megasample systems.

The systems are expandable. Expansion must be done with the same type memory blocks as in the original system or totally with new type blocks (after removal of existing memory cards). For



# Modular Digitizer Systems

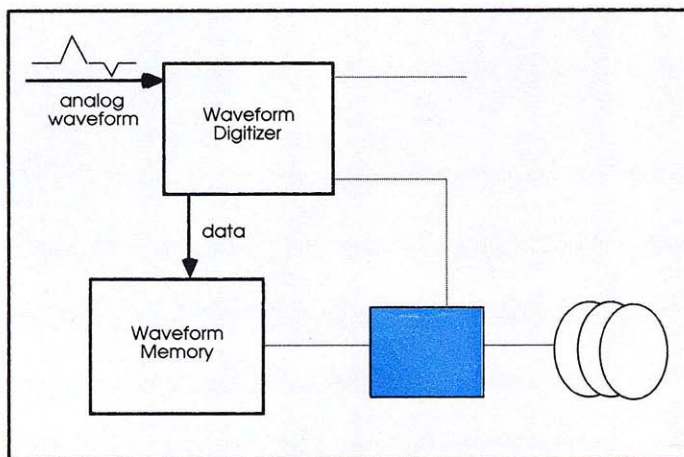

Acquire Waveforms

example, a 40 megasample system (Model 7900-140) can be expanded to 80, 120, or 160 megasamples adding one, two or three 40 megasample expansion blocks (Model 7900-40). Expansion beyond 160 megasamples requires removing existing memory cards and installing one, two, three or four 160 megasample blocks (Model 7900-160).

The WaveCorder System stores digital data at up to 200 megasamples per second using the LeCroy Model TR8828D waveform digitizer.

The 7900 waveform memory systems are upward compatible with future LeCroy digitizing systems and support up to 400 megasample/sec rates for 8-bit data.

## MEMORY SEGMENTATION

The segmentation of the waveform memory allows the user to record several sequential signals or events before reading them out to the host

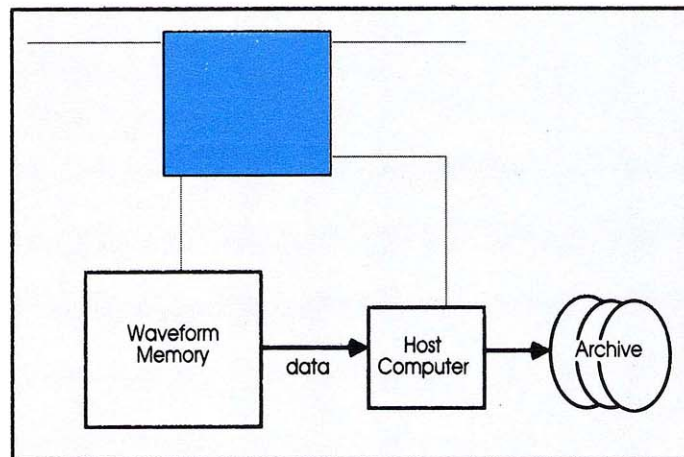

Archive Waveforms

computer. The minimum segment size is 20,480 samples; the maximum size is the entire memory. The number of segments is determined only by the total memory size and the programmed segment size, e.g., the 40 megasample memory can be configured from one continuous 40 megasample record to 2048 segments of 20 kilosamples each.

Each segment can be programmed by the host for various ratios of pre- and post-trigger. The amount of pretrigger is user selectable from 0% to 100% of the segment size in 20 sample increments. Post-trigger sampling can be selected from 0 to 80 gigasamples, creating a delayed trigger. The number of recorded samples is determined by the segment size.

## WAVEFORM ARCHIVES & ANALYSIS

The host computer can upload the waveform data from the 7900 memory mainframe for display and permanent storage. High capacity tape drives provide non-volatile mass storage. The

waveform data can be retrieved with full digital precision at a later date. LeCroy offers interfaces and associated driver software for either UNIBUS™ or QBUS™ links between the 7900 memory system and the VAX, MicroVAX II, or MicroVAX III hosts. In addition, a VME interface and a C Language Library of UNIX callable I/O drivers are also available for a SUN4-370 host.

## SOFTWARE

All WaveCorder systems come with starter software for the VMS or UNIX environments. This software provides basic functionality of the TR8818A or TR8828D digitizer module via a Model 6010 GPIB/RS-232 or a Model 8901A GPIB controller.

Callable VMS or UNIX device driver routines control the TR8818A/TR8828D digitizer, acquire high speed data from the digitizer into memory, and upload that data into the host memory at host bus speeds. Any section of a waveform can be selected for upload and analysis.



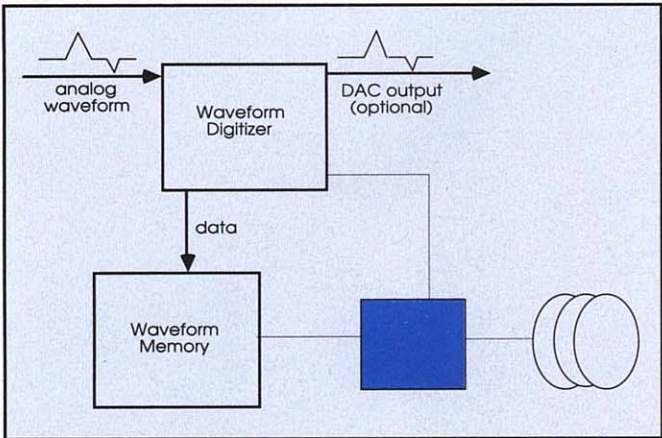

Acquire Waveforms with Immediate Replay

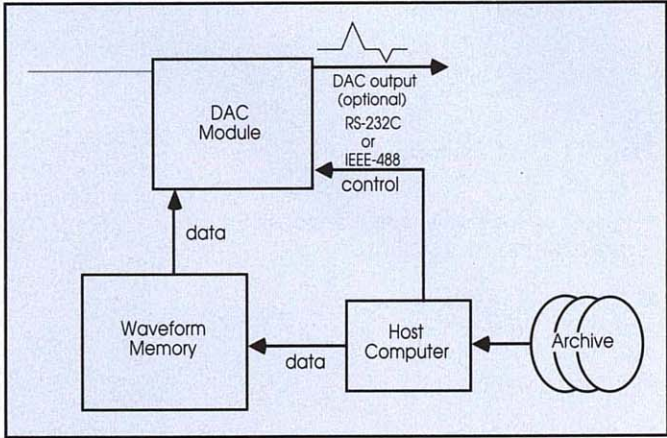

Playback or Simulate Waveforms

### WAVEFORM OUTPUT GENERATOR

The Model 7900-9109LM Waveform Output Generator provides variable-rate analog signal generation. Digitized waveform data can be immediately re-generated in analog form.

Previously acquired and archived data can be retrieved from the tape drive by the host, downloaded to the 7900 memory system, and then replayed via the 9109LM. Data from the entire memory, individual segments, or portions of a segment can be replayed. Mathematically generated waveforms can also be converted to analog for simulating conditions or events. The 9109LM is a modified version of the LeCroy 9109 Arbitrary Function Generator. As such, the 9109LM has the same analog output characteristics of the 9109, but generates its output via the Digitizer to Memory Interface Package (7900-IF251) from Waveform Memory.

### DIGITIZER SPECIFICATIONS

**DIGITIZERS:** See data on 6810 and TR8828D within this section.

**INTERFACES/CONFIGURATIONS:** See Accessories, page III-35.

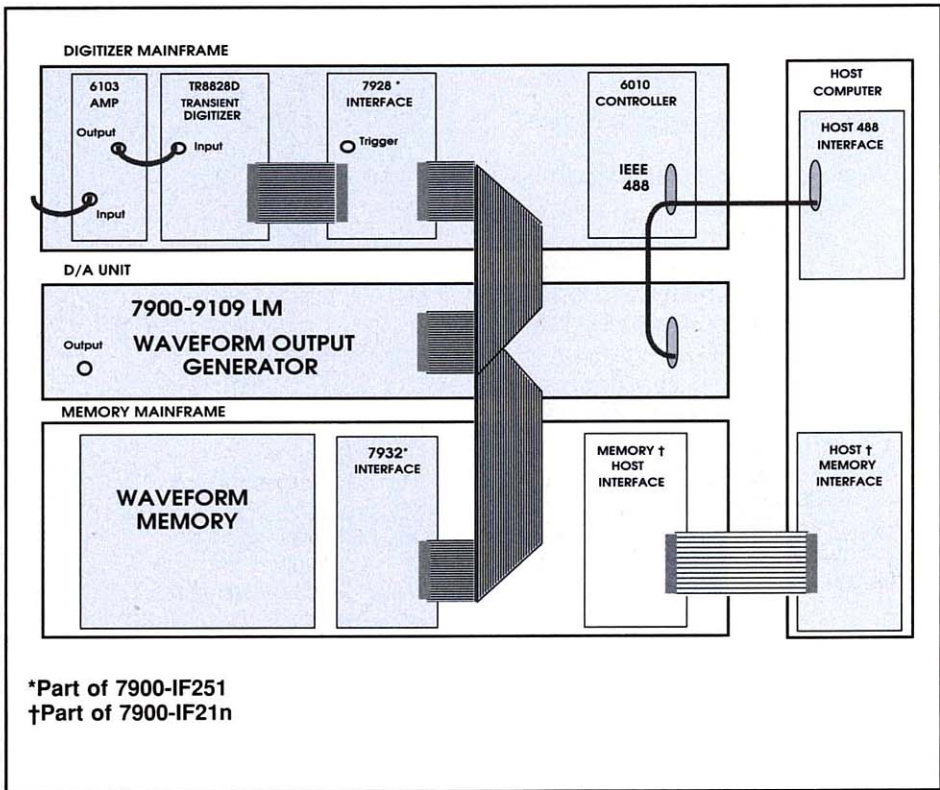

Hardware Configuration



## 6810 Waveform Recorder 6310 Memory

### Main Features

- 1, 2 or 4 channel simultaneous waveform sampling
- 5 megasample/second max. digitizing rate
- 12 bit resolution
- Up to 8 million samples of memory
- Up to 100 Volt differential inputs
- Over 4000 waveforms/second capture rate
- Trigger-point arrival time buffers
- Window and hysteresis triggering modes

### HIGH RESOLUTION RECORDING OF LONG SINGLE-SHOT WAVEFORMS

The LeCroy 6810 Waveform Digitizing/Recording system captures entire single-shot waveforms using digital storage techniques. Conversion of your analog waveform into digital data simplifies waveform analysis and allows storage on floppy disks and hardcopies on printers.

The LeCroy 6810 combines powerful waveform recording features not found on instruments costing many times more. These 6810 features mean simple solutions for applications including:

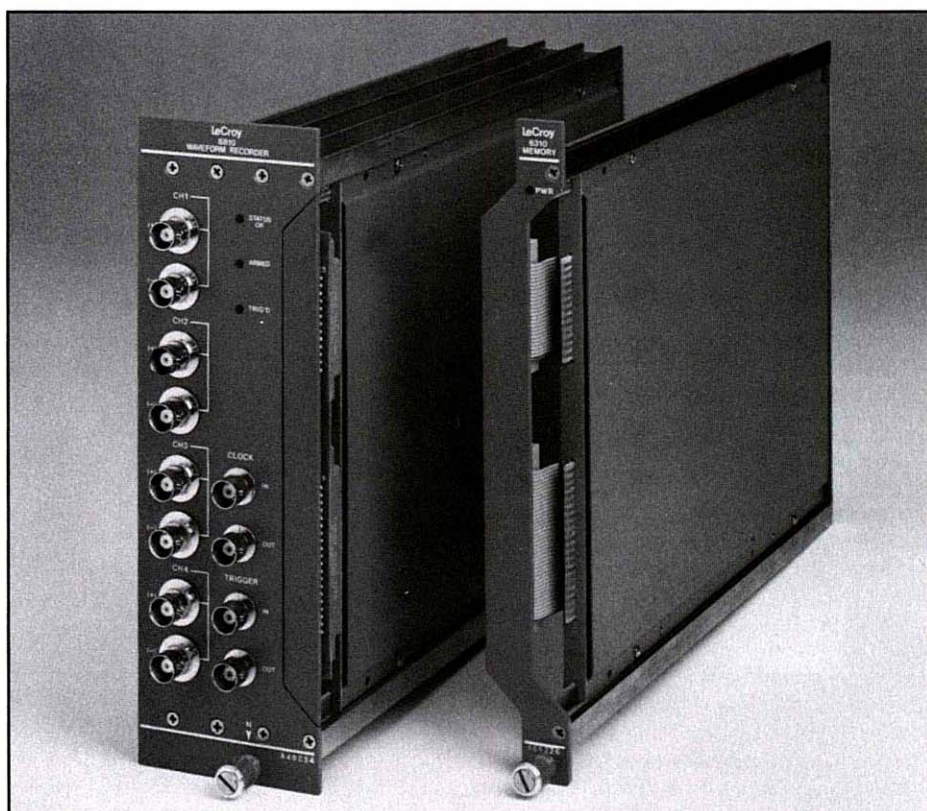

- Power monitoring
- Materials studies
- High voltage testing
- Biomedical research
- Noise & vibration testing
- Power supply testing & other ATE
- Automotive testing
- SONAR, RADAR & ultrasonics
- Geology/Seismology monitoring
- Magnetic media testing
- Ballistics/explosives testing

### Product Description

The LeCroy Model 6810 Waveform Recorder module is a complete independent recording system. Thus, it provides unprecedented total system performance for measuring DC to 2.5 MHz signals. The 6810 includes wide-range differential amplifiers, track and holds, a high resolution analog-to-digital converter (ADC), powerful triggering circuitry and on-board waveform memory. The memory can be expanded via Model 6310 Memory modules.



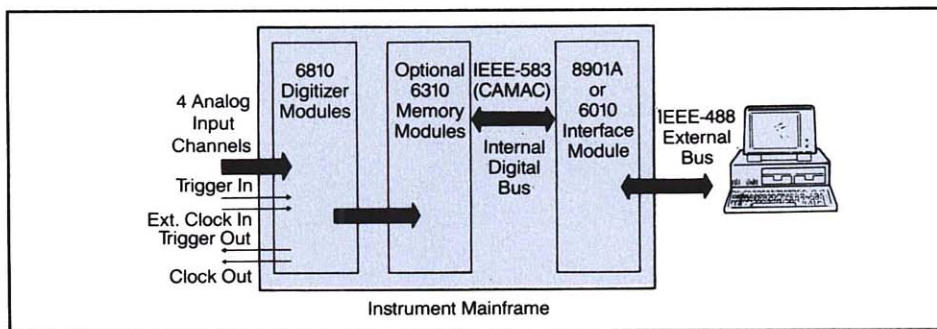

System Architecture

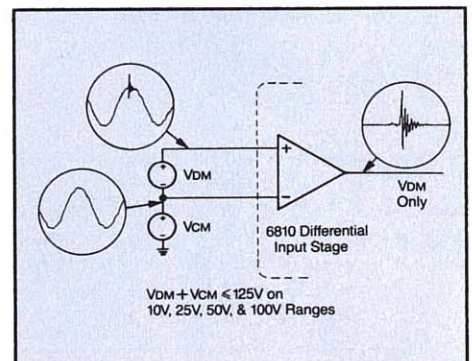

Common Mode Voltage Rejection

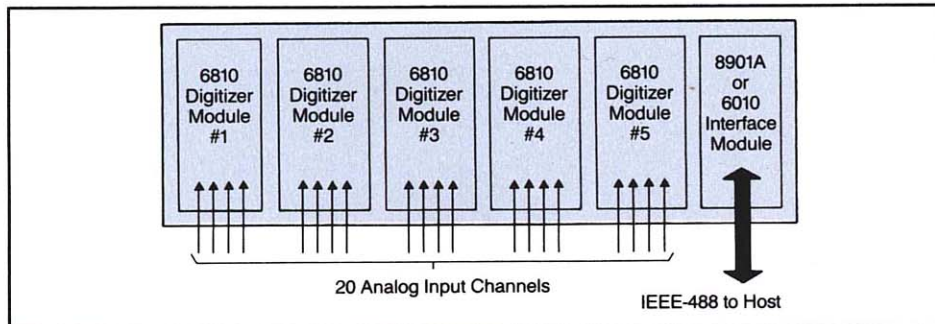

Extended Multi-Channel 6810 System

## MULTIPLE INPUTS

The Model 8013A benchtop mainframe can hold two 6810 modules for up to 8 channels. The Model 8025 rackmount mainframe can hold five 6810 modules for up to 20 channels. One IEEE-488 Standard interface port allows up to 280 channels in one system via 14 mainframes.

## DIFFERENTIAL INPUT CHANNELS

The 6810 Digitizer module contains four input channels with independent configuration, gain, offset and AC or DC coupling. Each channel has both a non-inverting (+) and an inverting (-) input

connector. The connectors can be configured in four different combinations:

- Differential (both + and - active)
- Non-Inverting (+ active, - grounded)
- Inverting (+ grounded, - active)
- Grounded (both + and - grounded)

Single-ended inputs can allow external electrical noise to mix with the desired waveform. But the 6810 differential inputs reject common mode noise and transducer bias voltages. They measure only the voltage difference between the inputs.

The 6810 module uses one selectable setting for all four channels for memory length, sample rate, pretrigger waveform length, trigger delay time and trigger source.

## FLEXIBLE TIMEBASE SETUPS

The 6810 sample rate can be programmed from 20 samples per second up to 5 million samples per second. The sample rate steps occur in a 1, 2, 5 sequence, just like an oscilloscope. The maximum sample rate depends upon the number of active channels:

- One Channel Mode: 5 MS/sec max.
- Two Channel Mode: 2 MS/sec max.
- Four Channel Mode: 1 MS/sec max.

The 6810 can also use an external clock source to establish the sample rate. Thus, the 6810 can be synchronized to your experiment or test. The external source can be any frequency from DC up to 5 MHz.

## SPECIAL DUAL TIMEBASE

A special dual timebase mode conserves waveform memory. It changes the sample rate during a waveform acquisition. A fast sample rate resolves



# Modular Digitizer Systems

detailed waveform sections. A slower rate conserves memory at other times. The user may select any two sample rates.

The user may assign either sample rate, f1 or f2, to the pre trigger waveform section, the post-trigger-near section and the post-trigger-far section. When in segmented memory mode, (see "Memory Segmentation") these three sections apply to each individual memory segment. Three f1/f2 combinations exist:

Pretrigger Section	Post-Trigger Near Section	Post-Trigger Far Section
f1	f2	f1
f1	f2	f2
f1	f1	f2

The user also selects the post-trigger-near section size. It may be as small as 4 samples or as large as all the post-trigger samples.

## SIMULTANEOUS MEASUREMENTS

Accurate multichannel comparisons and analysis, such as current and voltage monitoring for power calculations, demand simultaneous sampling. The 6810 uses track and hold circuits on each input channel (see 6810 Block Diagram). One sample clock controls all track and holds. Therefore, all four channels sample their inputs simultaneously, rather than sequentially like most other multiplexed systems. In addition, the LeCroy 6810 superb channel isolation prevents voltages on one channel from corrupting measurements on another channel.

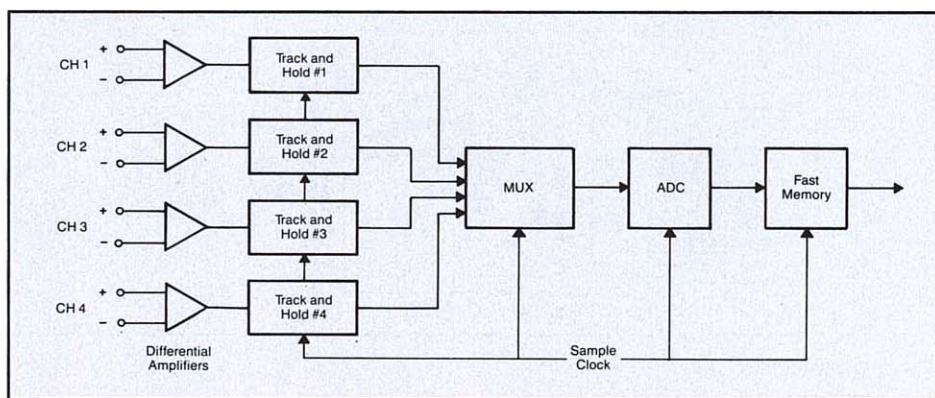

6810 Block Diagram

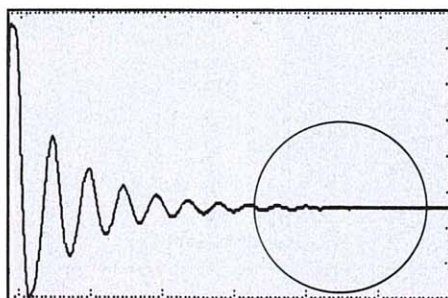

No Vertical Expansion

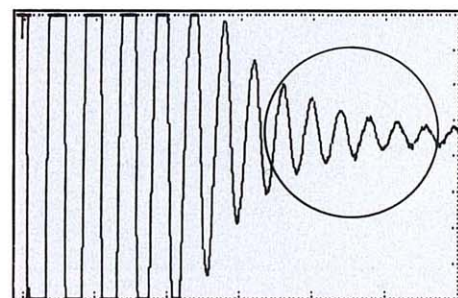

X16 Vertical Expansion

The 12-bit resolution 6810 captures much more detail than can be displayed on a computer display screen. Therefore, LeCroy's WAVEFORM-CATALYST software features vertical expansion.

## HIGH VERTICAL RESOLUTION

The 6810 contains a high accuracy, 12-bit resolution, analog-to-digital converter. In addition, each 6810 channel has eight input ranges from 400 mV to 100 V full scale. The combination of high resolution and multiple ranges means the 6810 can accurately record a waveform of almost any amplitude.

12-bit resolution equates to 4096 different detectable input levels. Thus, the 6810 can measure 100  $\mu$ V changes when on the 400 mV range. Repetitive-waveform averaging in the host com-

puter further increases resolution.

## DEEP WAVEFORM MEMORY

The 6810 stores digitized waveform data in fast memory. The 6810 module contains 512k samples of memory. Model 6310 Memory Expansion modules add 512k samples each. A maximum of 15 memory modules expand the system memory to 8 megasamples.

The 8 megasample system supplies a full 8 seconds of continuous recording time at a 1 MS/s sample rate or more than six minutes at 20 KS/sec.



## MEMORY SEGMENTATION

The 6810 memory can be divided into a maximum of 1024 segments. Each segment requires a separate trigger signal to initiate recording. Thus, numerous pulses can be recorded quickly without emptying memory after each capture, and without recording the deadtime between pulses. In this segmented memory mode, the 6810 can record up to 4880 waveforms per second (5 MS/sec, 1024 point segment).

The segmented memory mode also helps to precisely reconstruct the timing of intermittent waveforms. The 6810 records the trigger-to-trigger times from segment to segment. This trigger time stamp clock has variable resolution. And the long time stamp buffer shows up to 72 minutes between triggers with 1 microsecond resolution, up to 16 months with 10 msec resolution.

## POWERFUL TRIGGER MODES

All active 6810 input channels use the same trigger. The 6810 module will trigger when the trigger source meets specific waveform conditions or when a software trigger command occurs. Either an external trigger input, the Channel 1 signal, or the Channel 2 signal can act as the trigger source.

The 6810 supplies five different trigger condition selections:

- Positive Slope
- Negative Slope
- Window
- Positive Hysteresis
- Negative Hysteresis

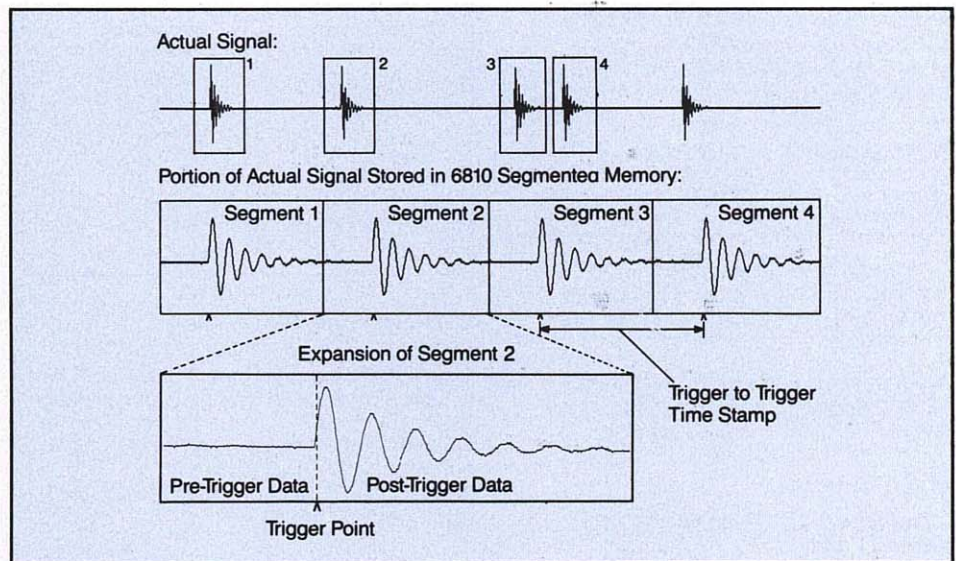

Trigger Modes

**Positive or Negative Slope** triggering simply occurs at a selected voltage level on the positive or negative slope of the trigger source signal.

**Window triggering** occurs when the trigger source signal passes in a positive direction through an upper trigger level or in a negative direction through a lower trigger level. The upper and lower levels are independent user-selected voltages.

**Positive and Negative Hysteresis** triggering makes the trigger point less susceptible to noise. A trigger will only occur after the signal has crossed a hysteresis level. This level can be thought of as a "trigger enable".

## FULL REMOTE CONTROL

All 6810 functions (gain, offset, coupling, etc.) are programmable and can be controlled remotely via the IEEE-488 Standard interface bus (GPIB). Either Model 8901A or Model 6010 interface modules provide this bi-directional GPIB communication. A host computer can download control and setup commands to the 6810 and upload waveforms from the 6810.



# Modular Digitizer Systems

## 6810 Specifications

All specifications refer to the guaranteed minimum performance of the entire 6810/6310 digitizing system. All selectable parameters are IEEE-488 bus and IEEE-583 (CAMAC) bus programmable.

### TOTAL DYNAMIC ACCURACY

Signal Frequency	Signal-to-Noise Ratio	Harmonic Distortion
200 kHz	67 dB	- 70 dB
1.0 MHz	66 dB	- 68 dB
2.5 MHz	62 dB	- 62 dB

(Performance measured by comparing a digitized bipolar 95% FS sinewave using internal 5 MHz clock against ideal results.)

### ANALOG INPUTS

**Connectors:** 2 BNC type coaxial per channel (+ and -)  
**Quantity:** 4 input channels, simultaneously sampled  
**Active Number of Channels:** 1, 2 or 4  
**Channel Isolation:** 66 dB minimum between any two channels  
**Input Modes:**  
 1. Differential (both + and - active)  
 2. Non-inverting (+ active, - grounded)  
 3. Inverting (- active, + grounded)  
 4. Both connectors grounded.  
**Common Mode Rejection Ratio:** (differential input mode):  
 0.4 V, 1 V, 2 V, 4 V ranges  
     66 dB @ DC, 50/60 Hz, 400 Hz  
     63 dB @ 100 kHz  
 10 V, 25 V, 50 V, 100 V ranges:  
     54 dB @ DC, 50/60 Hz, 400 Hz  
     51 dB @ 50 kHz  
**Common Mode Voltage:** 125 V max. on 10 V, 25 V, 50 V and 100 V ranges  
 5 V max. on 0.4 V, 1 V, 2 V, and 4 V ranges  
**Bandwidth:** DC to 2.5 MHz minimum  
**Pulse Response:** Tr <120 nsec, with <5% overshoot  
**Coupling:** AC or DC  
**Input Impedance:** ≈ 1 MΩ, 40 pF  
**Voltage Range:** Selectable in 8 steps

Full scale Input voltage	Sensitivity
400 mV	100 μV
1 V	250 μV
2 V	500 μV
4 V	1 mV
10 V	2.5 mV
25 V	6.25 mV
50 V	12.5 mV
100 V	25 mV

**Overload Protection:** ± 100 VAC or DC continuous

**Overload Recovery Time:** 1 μsec to within ± 1.5% from a 3X full scale, 10 μsec duration input

**DC Gain Non-linearity:** ± 0.1% maximum of full scale

**Offset:** Up to ± 50% full scale. Selectable in 256 steps

### TIMEBASE

#### Internal Sample Clock Rates:

5M\*, 2M\*\*, 1M, 500k, 200k, 100k, 50k, 20k, 10k, 5k, 2k, 1k, 500, 200, 100, 50, or 20 samples/sec  
 \* 1 channel mode only

\*\* 1 or 2 channel modes only

**Dual Timebase:** 2 selectable timebase changes within each memory segment.

Sample rate changes at trigger point and 'N' samples after the trigger point in an combination.

Pretrigger	Post-Trigger NEAR	Post-Trigger FAR
rate 1	rate 1	rate 1
rate 1	rate 2	rate 1
rate 1	rate 2	rate 2
rate 1	rate 1	rate 2

Sample rate 1 and rate 2 may be any of the internal rates;

Clock In disabled in dual timebase mode, Clock Out available

**Clock In:** BNC connector  
 Any external frequency from DC to 5 MHz  
 Must be a 74 HC series TTL compatible signal

**Clock Out:** BNC connector  
 Buffered internal sample clock  
 50 Ohms drive capability  
 Short circuit protected  
 40 nsec maximum propagation delay  
 "Clock In" to "Clock Out"

### ANALOG TO DIGITAL CONVERSION

**Resolution:** 1:4096 (12 bits)

**Aperture Uncertainty:** <50 psec @ 5 MHz internal clock rate

### TRIGGERING

**Minimum Trigger Signal Duration:** 50 nsec

**Trigger Source:** Selectable from either external (Trigger In), internal, or manual (bus command)

**Trigger In:**

BNC connector  
 1 MΩ input impedance  
 Protected to ± 50 V  
 Range from - 5 V to + 5 V

**Internal Trigger:** Pickoff from channel 1 or 2;

Range from - full scale to + full scale

**Trigger Level:** 256 steps across range;

1 level for single slope trigger modes;

2 independent levels for window and

hysteresis modes

**Trigger Modes:** Positive slope

Negative slope

Window

Positive hysteresis

Negative hysteresis

**Trigger Coupling:** DC, AC

Low frequency reject (-3dB @ 36 kHz, 20 dB/decade roll off)

High frequency reject (-3dB @ 36 kHz, 20 dB/decade roll off)

**Trigger Not Accepted During:**

1. Programmed "Trigger Disable"
2. Pre-trigger recording when "Trigger Holdoff" enabled
3. Post-trigger recording
4. First 160 microsec after last post-trigger sample in the previous memory segment



## Trigger Out: BNC connector

Trigger signal for synchronized multiple 6810 operation

50  $\Omega$  drive capability

Short circuit protected

80 nsec maximum propagation delay "Trigger In" or internal trigger to "Trigger Out"

**Pretrigger:** Portion of memory filled with waveform data occurring before valid trigger condition.

Selectable in 1/8ths of the memory segment length from 0/8 (100% post trigger, no-trigger data) to -8/8 (100% pretrigger data).

**Delayed Trigger:** Time delay from valid trigger condition to the start of memory segment recording.

Selectable time  $T=(L)(S)(P)$  where:

L = selectable memory segment length fractions (1/8 to 247/8)

S = number of samples per memory segment

P = sample interval

**Example:** Sampling at 1 MS/sec with a segment length of 4096 samples and a delay trigger setting of 19/8 yields 9.73 msec delay after the trigger before recording begins.

$(1 \mu\text{sec/sample})(4096)(19/8)=9.73 \text{ msec}$

**Time Stamps:** The elapsed time from Arm to first Trigger, from first Trigger to second Trigger, and so on, each value stored in a buffer

Applies when number of channel memory segments >1

1024 time stamp buffers (bus readable as a block)

32-bit resolution

Selectable time sensitivity

Sensitivity (1 bit)	Maximum Representable Time Before Buffer Rollover (32 bits)
1 $\mu\text{sec}$	71.58 minutes
10 $\mu\text{sec}$	11.93 hours
100 $\mu\text{sec}$	4.97 days
1 msec	49.71 days
10 msec	>16 months

## WAVEFORM MEMORY

**Internal:** 512k samples

**Expansion:** Additional 512k samples per each Model 6310 Memory module  
8M samples maximum total memory via 15 Memory modules

Total memory required for application = (S)(G)(C) where:

S = number of samples per memory segment

G = number of memory segments

C = number of active channels (1, 2 or 4)

**Segmentation:** Memory divided into segments; separate trigger for each segment, records only to end of segment for each trigger

Selectable pre-trigger/post-trigger percentage; percentage same for all segments on all channels

Dual timebase for each segment, same mode for all segments

**Segment Size:** Selectable in binary increments from 1024 samples to the full memory length

**Segment Record Rate:** Sample rate divided by samples per segment 4880 segments/sec maximum (5 MS/sec, 1024 sample segment)

### Readout:

1. Entire active memory
2. Any active channel's memory
3. A memory section starting at any particular segment sample point (Offset command) and terminating at any other sample point in active channel memory (Abort command)

**Readout Rate:** 225 ksamples/second maximum via LeCroy 8901A IEEE-488 Interface.

## WAVEFORM AVERAGING

**Averaging Rate:** 93 waveforms/sec. max.

**Hardware Required:** 6010 controller (for additional specs, see 6010 data sheet)

## STATUS INDICATORS

**LEDs:** STATUS OK - Received valid setup command across bus

ARMED - Currently digitizing

TRIG'D - Trigger accepted and 6810 now digitizing post-trigger samples, if any selected

**Module I.D.:** Bus readable binary value "6810"

## ENVIRONMENTAL

### MECHANICAL

**Packaging:** R.F. shielding in conformance with IEEE-583 Standard (CAMAC)

Module	Size	Height	Width	Depth
6810	4 slots	221 mm	68 mm	292 mm
6310	1 slot	221 mm	17 mm	292 mm

Power:	Module	+6 V	-6 V	+24 V	-24 V
6810		6 A	3 A	1.2 A	1.2 A
6310		1.7 A	-	-	-

**Operating Temperature:** +15° to +35° C (IEEE-583 instrument mainframe maximum exhaust temp. must be less than 50° C)

**Storage Temperature:** -10 to +50° C storage

**Operating Humidity:** 10% to 90% non-condensing

**Operating Altitude:** 0 to 10,000 feet above sea level

## ORDERING INFORMATION

6810	Waveform Digitizer Module
6310	512K sample Memory Expansion Module



# 8212A Simultaneous Sampling Data Logger

### Main Features

- Up to 32 inputs
- Simultaneous independent measurements
- 12 bits resolution
- 50 kHz bandwidth
- Differential inputs
- 40 kHz maximum sampling rate
- Expandable memory
- Low cost per channel

### General Description

The LeCroy Model 8212A is a multi-input 12 bit data logger/waveform digitizer for use in low frequency transient monitoring applications. The Model 8212A contains 32 independent channels with simultaneous sampling speeds from 40 kHz to 0.2 kHz depending upon the number of active channels.

The Model 8212A is ideal for recording multisecond-type transients from transducer-based applications including:

- Strain/stress
- Thermocouple
- Bio-medical
- Shock/vibration
- Acoustics
- Magnetics

The number of active inputs is programmable. As fewer inputs are used, available memory storage per channel and maximum achievable sampling rate increase.

Full differential inputs accept  $\pm 5$  V signals (or by factory modification, 10 V signals of either polarity). Common Mode rejection, better than 40 dB at 4 kHz and 66 dB under 500 Hz, reduces noise and thereby maintains the high accuracy.

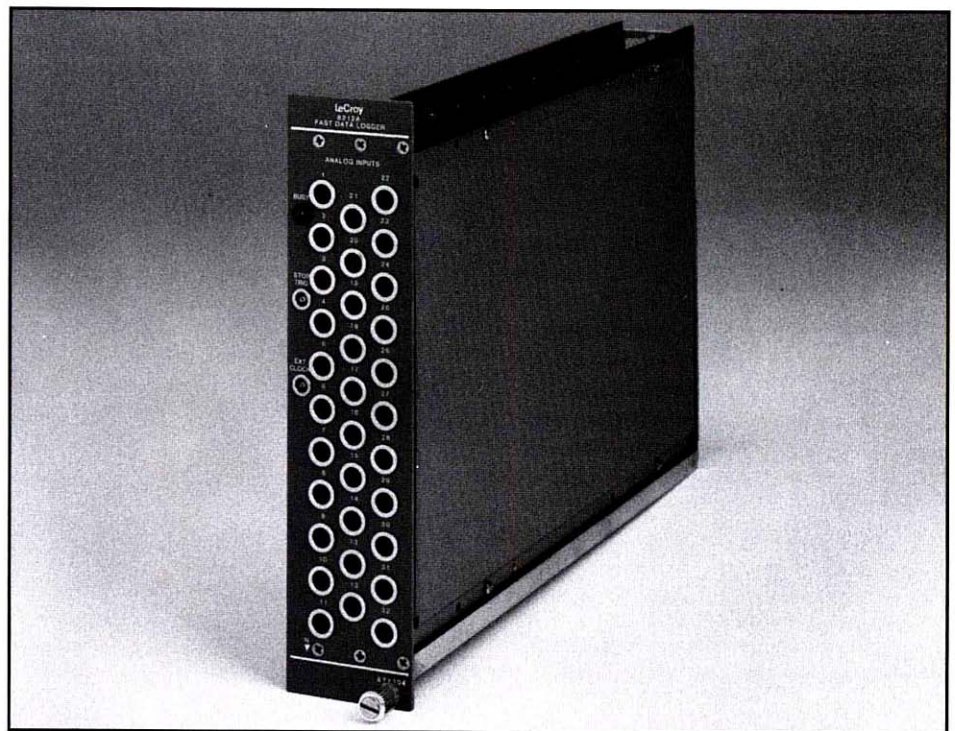

The 8212A samples all inputs simultaneously. Each input to the digitizers has a separate track-and-hold driven by a common clock, minimizing aperture uncertainty and channel-to-channel phase shifts in the digitized waveforms.

The 8212A can be used in one of two modes. In a "Sweep-and-Log" mode the data logger continually samples all channels simultaneously. A "Single Scan" mode allows one sample on each active input to be acquired under direct computer supervision for real-time control applications. The analog signal level from each channel's independent track-and-hold is converted sequentially, each measurement requiring less than 6  $\mu$ sec dwell time. Therefore, a com-

plete scan of 32 inputs takes less than 200  $\mu$ sec.

Digitizing is governed either by the internal clock or by clock cycles applied to an external clock input. The data is sequentially stored in up to four Model 8800A 32K word memory modules. Equal memory segments are automatically assigned to the programmed number of active channels. In the Sweep-and-Log mode, memory is continually overwritten retaining only the most recent conversions. An externally applied Stop Trigger or a command will stop the digitizer and memory, either instantly or after pre-programmed number of post-trigger conversions, thus capturing a digitized window of interest.



## 8212A Specifications

### ANALOG INPUTS

**Channels:** 32 differential (Lemo connectors), direct coupled, 1MΩ input impedance.

**Active Inputs:** The number of active inputs can be programmed as either 4, 8, 16, or 32.

**Bandwidth:** 50 kHz.

**CMRR:** 66 dB (DC-500 Hz), greater than 40 dB at 5 kHz.

**Crosstalk:** 66 dB isolation or better between any two channels, from DC to 500 Hz, greater than 40 dB at 5 kHz.

**Overvoltage Protection:** ±140 V DC or 115 V rms at 60 Hz across input pins, or either pin with respect to ground.

### ANALOG-TO-DIGITAL CONVERSION

**Range:** ±5 V full-scale. 0 to +10 V or 0 to -10 V full-scale is available as a factory installed option.

**Resolution:** 12 bits (0.025% of full scale with ±1/2 LSB relative accuracy).

**Gain Accuracy:** Maximum channel-to-channel variation is ±0.1% and stable within ±0.2% over a 10°C to 40°C range.

**Integral Non-linearity:** ±1/2 LSB.

**Conversion Time:** Approximately the number of active channels times 5.5 μsec.

### FRONT-PANEL CONTROLS

**Busy:** LED lit indicates conversion is in progress.

**Stop Trigger:** Lemo connector, 510Ω, TTL compatible, edge sensitive.

**External Clock:** Lemo connector, 510Ω, TTL compatible, edge sensitive.

### TIMEBASE

**Clock Source:** Internal, external, or one sample per command.

#### Sample Rate:

Number of 8212A Active Inputs	Internal Clock	8212A External Clock
4	40 kHz	DC to 40 kHz
8	20 kHz	DC to 20 kHz
16	10 kHz	DC to 10 kHz
32	5,2,1,0.2 kHz	DC to 5 kHz

### READOUT

**Internal Memory:** In data logging configuration (no external memory modules), the internal memory provides one voltage sample per channel. Before or during any scan, the 8212A may be switched to the Single Scan mode via a CAMAC command which causes a LAM/SRQ to be generated when conversion is complete. The internal memory can then be read out at the maximum CAMAC rate.

**External Memory:** Model 8800A memory modules let the 8212A act as a transient waveform digitizer. After the stop-trigger and post-trigger samples, the 8212A automatically enters the data output mode. Data can be read out channel-by-channel, or in a high-speed block readout. In the block, data from all channels is interlaced.

**Output Port:** TTL data levels: one 40-conductor cable (Model DC8800); consists of 12 data lines, 12 grounds, 7 control lines, and 7 grounds. Output is compatible with LeCroy Model 8800A 32K memory module. Up to four memory modules may be used with one 8212A.

### GENERAL

**Packaging:** RF-shielded in conformance with IEEE-583 standard (CAMAC):

Module No.	Size	Height	Width	Depth
8212A	3 Slots	221 mm	51 mm	292 mm
8800A	1 Slot	221 mm	17 mm	292 mm

### Power Requirements:

1A at +6V                      325 mA at -6V  
310 mA at +24V              240 mA at -24V



## 2262 Quad Waveform Digitizer

### Main Features

- Four digitizers per module
- 40 megasamples/sec digitizing rate
- 80 Megasamples/sec effective sampling rate in biphase mode
- 40 MHz analog bandwidth
- 10 Bit resolution
- 316 or 632 sample record length
- Modular system, easily expandable
- Complete software support

**Four Digitizers per Module** - Each 2262 has four inputs and is capable of measuring four waveforms simultaneously at the sampling frequency or two waveforms at double that frequency.

**Sampling Rates to 80 Megasamples/sec** - Standard sampling rate is 40 megasamples/sec with a 316 sample record/input. The Biphase Mode permits doubling the sample rate to 80 megasamples/sec for two signal inputs with 632 samples per input.

**40 MHz Analog Bandwidth for Bipolar Inputs** - Input range is a full 1.5 V, offset anywhere between -1.5 V and +1.5 V to ensure adaptability to the polarity characteristics of your signal.

**10-Bit Resolution** - A wide 10-bit dynamic range gives 1.5 mV resolution over a full scale of 1.53 V. Provides

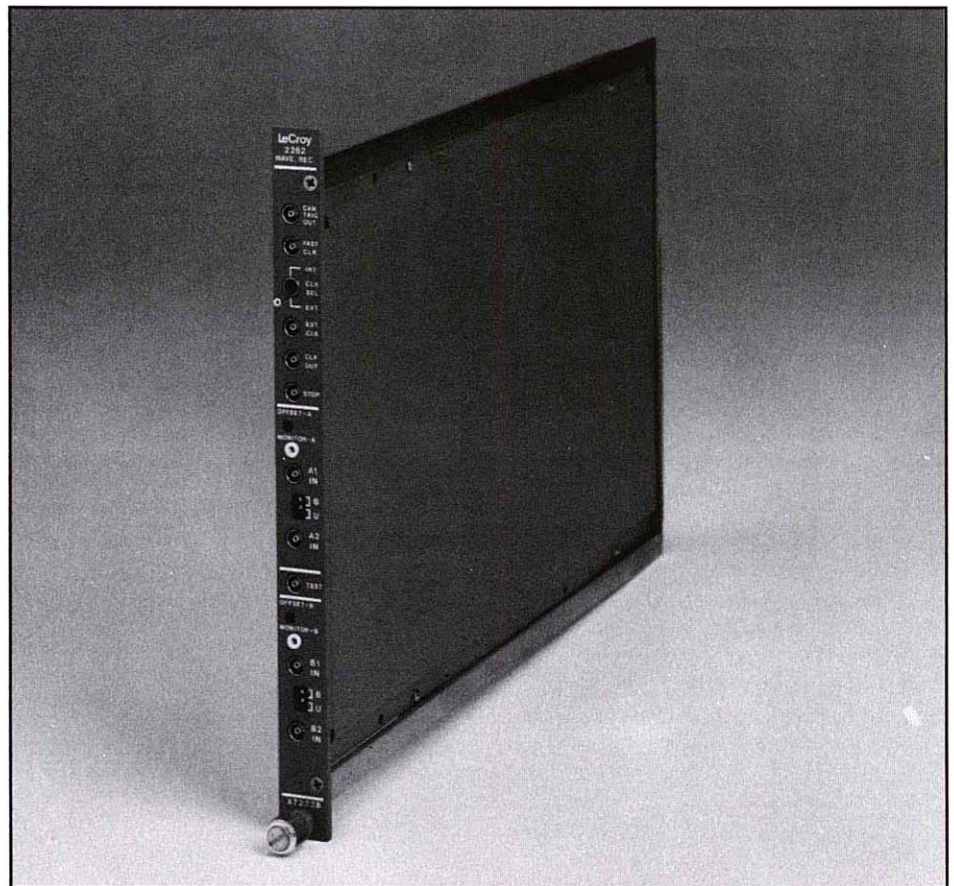

maximum detail capture in your measurement.

**Built-in Calibration** - Internal DACs allow calibration under software control to ensure maximum fidelity of measurement regardless of the time and temperature.

**Custom Time Bases** - Instead of the internal crystal oscillator, an external time base can be used to introduce a custom clock and to permit the synchronization of more than one 2262.

**Fast Clear** - Should post-trigger factors demand, fast clear allows simultaneous conversion abort in all channels. Readies the 2262 for a new measurement.

**Convenient Test Capability** - Front-panel input applies identical test signals to all four channels.



## **Modular System, Easily Expandable -**

Up to 32 recording channels can be accommodated in a standard LeCroy 8025 rack-mount power housing. Up to 80 channels can be implemented with external +12 V power. In addition to the already low cost of each plug-in channel itself, the power and interfacing overhead cost is also minimized by this high density. The 2262 plug-ins can be controlled and read out via an accessory interface and GPIB or via any direct standard-CAMAC interfaces available for a variety of host computers.

**Complete Software Support -** Control, readout, and display can be conveniently handled by IBM PC-compatible WAVEFORM CATALYST software which supports all of LeCroy digitizers.

## **Product Description**

The Model 2262 is a high-speed plug-in waveform digitizer providing high resolution, multichannel, short record solutions to large scale waveform recording requirements. Designed in a modular standard for ease of system

configuration, the 2262 offers four digitizers per module. The 2262 is compatible with CAMAC (IEEE-583) and GPIB (IEEE-488) operation, and works with IBM PC™ based software for easy, user oriented, waveform display and control.

The Model 2262 is a multichannel waveform digitizer based upon the LeCroy MVV200 high performance charge coupled device (CCD). It may be operated in one of two modes, Uniphase or Biphase. Uniphase mode provides four channels at up to 40 MHz sampling rates. Each of the four channels has a record length of 316 samples. In the Biphase mode, two channels are internally tied to one input connector and alternately sampled to provide an effective sampling rate up to 80 MHz and a record length of 632 samples.

The signal to be digitized may be connected directly to the 1.5 V full-scale input or via a modular amplifier (LeCroy 6103) if gain control is required. The operating range of 1.5 V may be offset via front-panel control over a range of anywhere between -1.5 V and +1.5 V. Test points at the front-panel monitor the

offsets to facilitate settings. Internal calibration DACs allow fine trimming of offset characteristics via software control to ensure maintenance of full dynamic range during use.

The Model 2262 is a 100% pretrigger device, i.e., when the stop signal is applied, the CCDs are stopped and the last 316 cells (632 cells for Biphase mode) are available for digital conversion and read out.

The Model 2262 is designed in CAMAC-standard format (IEEE 583). Interfaces, control and thousands of accessory modules already exist for application-oriented system configurations. GPIB control is available from LeCroy via the Model 8901A GPIB interface. This allows virtually any computer with a IEEE-488 (GPIB) interface to control and read out the digitizers and any associated supporting system modules. LeCroy WAVEFORM CATALYST software creates a user-friendly atmosphere for controlling the 2262.



## 2262 Specifications

### SIGNAL INPUT CHARACTERISTICS

**Number of Signal Inputs:** 4 in Uniphase mode; 2 in Biphasic mode.  
**Amplitude Range:** 1.53 V p-p (1.5 mV/LSB)  $\pm 2\%$ .  
**Impedance:** 50 Ohms  $\pm 5\%$  DC.  
**Bandwidth:** DC to >40 MHz (-3 dB).  
**Slew Rate:** >120 V/ $\mu$ sec (typ: 150 V/ $\mu$ sec).  
**Offset Range:** Two front-panel screwdriver adjustments with front-panel monitor points. One for Channels A1 and A2, one for B1 and B2. Operating range may be set to cover any 1.5 V range between -1.5 V and 1.5 V.  
**Monitor Test Points:** Two front-panel probe points for offset monitoring. One for Channels A1 and A2, one for B1 and B2. Range -1.5 V to +0 V. (The voltage measured is the most negative point of the input voltage range.)  
**Overload Recovery:** Recovers to  $\pm 1\%$  of full scale within 2 samples of 2 x overdrive pulse.  
**Overload Protection:**  $\pm 5.0$  V.  
**Test Input:** Lemo connector; impedance 50 Ohms  $\pm 5\%$ . When selected, signal is sampled by all four channels. When no connection is made, the digitizing of the Test input provides a convenient ground reference for offset measurement.

### OUTPUT CHARACTERISTICS

**Record Length:** 316 samples for Uniphase mode; 632 for Biphasic mode. Maximum data record length may be reduced by hardware option in modules for specialized applications, reducing both conversion and readout time.  
**Resolution:** 1.5 mV.  
**Digital Format:** 10 bits (1024 counts).  
**AC Accuracy:** Ranges from  $\pm 0.25\%$  to  $\pm 1.5\%$  depending upon input signal frequency and amplitude. See instruction manual for specific performance curves.  
**Non-linearity:**  $\pm 0.5\%$  of best straight line fit over the operating range.  
**Random Noise:** <1 count RMS.  
**Spatial Noise:** <3 counts p-p; stable to <1 count under constant frequency and temperature operation. The first 2 bins of each channel are excluded from the spatial noise specification.  
**Gain Temp Coefficient:**  $\leq \pm 1000$  ppm/ $^{\circ}$ C.  
**Offset:** Temperature coefficient: <1 count/ $^{\circ}$ C.

**Droop:** A linear change of offset from sample to sample. Increases with ambient temperature and/or acquisition clock rate. Unadjusted Droop: <0.05 counts per sample. Adjusted Droop using droop fine trim DACs: <0.007 counts per bin. Fine Trim DAC Gain: 0.5 with respect to offset difference from sample 0 to sample 315.

**Interchannel Matching (All four channels):** Gain <1% maximum, typical <0.3%. Unadjusted Offset: <15 counts; Adjusted Offset using offset fine trim DACs: <2 counts. Fine Trim DAC Gain: 0.5.

**Interchannel Isolation:** 55 dB any A Channel to any B Channel. 48 dB Channel A1 to A2 and Channel B1 to B2 (at 40 MHz clock rate; better at lower clock rates).

**Digitizing Time:** Approximately 1.3 msec for Biphasic 632 sample or Uniphase 316 sample conversion to digital memory. Correspondingly less for hardware programmed shorter record lengths.

### TIME BASE

Front-panel switch selects the source of the sample clock, internal or external.  
**Internal Clock:** Crystal controlled oscillator operating at 80 MHz (equivalent to 40 MHz sampling in Uniphase mode). Other oscillator crystals may be user installed.  
**CLOCK IN:** NIM standard input via a Lemo connector. Impedance 50 Ohms. Frequency range: 8 MHz to >80 MHz. Minimum width 5 nsec. Every other negative going edge causes the sampling of the even numbered inputs. Alternate negative going edges sample the odd channels.  
**CLOCK OUT:** NIM standard output via a Lemo connector; 50 Ohms. Ungated representation of clock used to operate CCD channels in acquisition mode. May be used as monitor or as input source for another 2262 CLK IN, to achieve matching of sampling rates. Prop. delay CLK IN to CLK OUT: 6 nsec typical.

### TRIGGERING

**Common Stop:** NIM standard input via a Lemo connector. Impedance 50 Ohms. Terminates acquisition mode on leading edge; begins data conversion on trailing

edge. Width: must be greater than 1 period of the acquisition clock or >50 nsec; 100  $\mu$ sec max.

**Fast Clear:** NIM standard input via a Lemo connector. Impedance 50 Ohms. Terminates conversion in progress. Enables the unit for data acquisition; 50 nsec minimum width.

**CAMAC Trigger Output:** Front panel NIM trigger output. Generates a NIM level of approximately 200 nsec duration upon software command.

### GENERAL

**Environment:** Operating Temperature Range: 0 to 60 $^{\circ}$ C. Above specifications guaranteed when used in LeCroy 8025 Power Housing or other CAMAC crate providing cooling airflow sufficient enough to insure an exhaust temperature of 45 $^{\circ}$ C max.  
**Front-panel Connectors:** Lemo.  
**Power:** In general, power requirements decrease as clock rate is reduced. Examples are given below.

Voltage	Current (40 MHz Uniphase)	Current (10 MHz Uniphase)
+6 V	750 mA	740 mA
-6 V	1225 mA	950 mA
+12 V	600 mA	215 mA
+24 V	190 mA	190 mA
-24 V	70 mA	70 mA

**Packaging:** In conformance with CAMAC standard for nuclear modules (IEEE 583). RF shielded CAMAC #1 module. Height: 221 mm; width: 17 mm; depth: 292 mm.

### Optional Crystal Oscillators

Crystal Frequency (MHz)	Uniphase (MHz)	Biphase (MHz)	Part Number
20	10	20	309 040 020
32	16	32	309 040 032
40	20	40	309 040 040
50	25	50	309 040 050
62.50	31.25	62.50	309 040 062
70	35	70	309 040 070
80*	40*	80*	309 040 080

\*Factory Supplied



## Cables, Interfaces & Accessories for Digitizer Systems

DESCRIPTION	MODEL	DESCRIPTION	MODEL
<b>CABLES</b>		<b>PULSERS</b>	
RG-174 BNC-BNC, 4 Ft.	BC/BC-4	Instapulser, 10 KHz, 2 nsec	
Kit, 8 inputs 1 Lemo Male, BNC	CK8212	FWHM pulse output	IP-2
Female Adapter for 8212A			
GPIB (IEEE-488), 2 meters	DC/GPIB	<b>7900 SERIES COMPONENTS</b>	
RS-232C for 6010 Controller	DC6010	Memory Mainframe, 10 MS	7900-001
TR8818/28 Memory Expansion, 34 Cond.	DC8134N	Memory Mainframe, 20 MS	7900-002
TR8818/28 Memory Expansion, 50 Cond.	DC8150N	Memory Mainframe, 40 MS	7900-104
8212A Memory Expansion		Memory Mainframe, 80 MS	7900-108
(N=# of memory modules)	DC 8800/N	Memory Mainframe, 120 MS	7900-112
6 Ft. RG-174, Lemo to BNC	LE/BC-6	Memory Mainframe, 160 MS	7900-416
3 Ft. RG-174, Lemo to Lemo	LE/LE-3	Memory Mainframe, 320 MS	7900-432
		Memory Mainframe, 480 MS	7900-448
<b>COMPUTERS</b>		Memory Mainframe, 640 MS	7900-464
Compaq III Portable	6900COMP3	Memory Expansion Kit, 10 MS	7900-10
Compaq 20E w/ VGA monitor	6900/20VGA	Memory Expansion Kit, 40 MS	7900-40
		Memory Expansion Kit, 160 MS	7900-160
<b>CONNECTORS</b>		Shipping Container	7900-C100
Male Differential Lemo	CKDLEM	Rack Enclosure	7900-E100
Male Coaxial Lemo	CKLEM	Rack Enclosure & Front Door	7900-E150
		Interface Package - UNIBUS	7900-IF211
<b>FRONT PANELS</b>		Interface Package - QBUS	7900-IF212
Blank CAMAC #1	BFP-1	Interface Package - VME/UNIX	7900-IF213
Blank CAMAC #2	BFP-2	Interface Package - IBM-AT BUS	7900-IF214
		Interface Package - Digitizer-to-Memory	7900-IF251
<b>INTERFACE CARDS</b>		Interface Package - Dual Channel	7900-IF280
National Instruments		Software Package - IBM-AT	7900-SI100
GPIB/PC-2	6900IC	Software Package - VME/UNIX	7900-SU100
		Software Package - VAX/VMS	7900-SV100
<b>GRAPHICS CARDS</b>		Training Course - On-site (2-day) USA	7900-T100
EGA. (Use with Monitor 2)	6900EGA	D/A Unit, (9109 AFG - Modified)	7900-9109LM
<b>MONITORS</b>			
EGA Color	Monitor2		



# 6103 Dual Amplifier/Trigger Generator 8102-6 Channel Attenuator

### General Information

LeCroy signal conditioning modules 6103 and 8102 provide amplification and attenuation of analog signals for matching the user's signal to the input range of one of LeCroy's wide selection of modular waveform digitizers. Conditioning modules are efficiently designed as multichannel packages providing space and cost economies for multiple channel digitizing systems.

Model 6103 is a general purpose amplifier. However, it has been optimized for use with LeCroy high-speed digitizing modules TR8828D, and TR8818A. Total programmability is incorporated into the Model 6103. It also incorporates a trigger generation section for triggering digitizer modules.

Multichannel attenuation of signals over a broad range of frequencies is offered with the Model 8102. The 8100 provides conditioning to drive LeCroy 8212A multichannel digitizers.

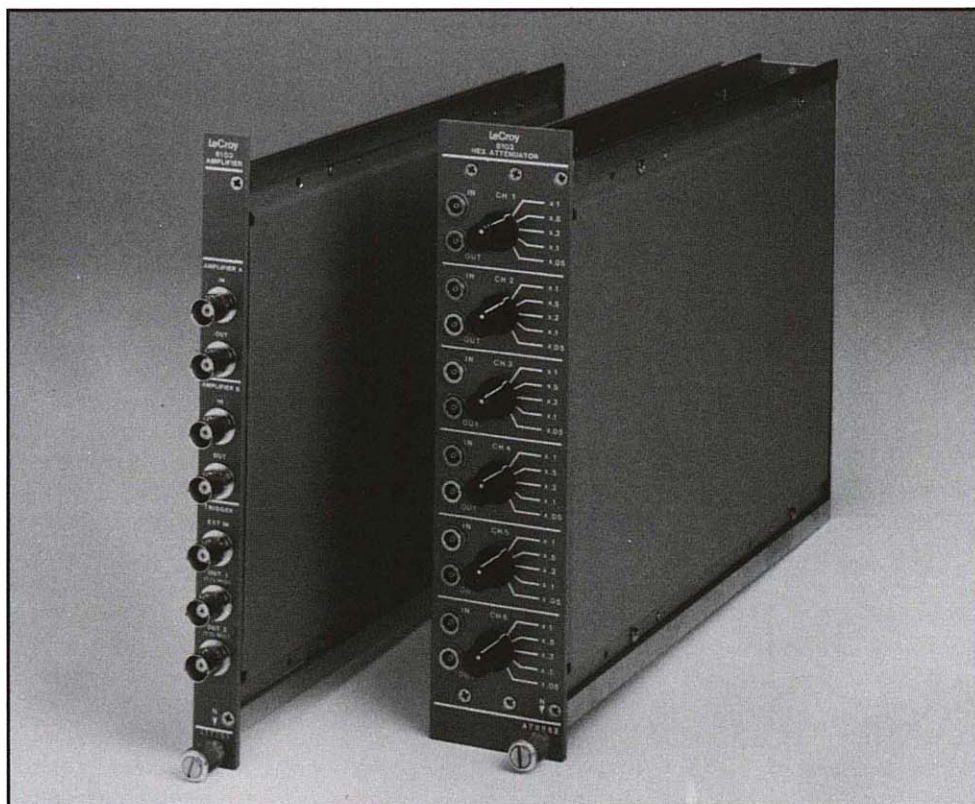



## Main Features

- **Selectable Input Options** - Choice of high or low impedance inputs and capacitive couplings in the Model 6103 provide conditioning for all types of signal sources.
- **Broad Bandwidth** - Flat frequency response at high frequencies amplifies or attenuates input signals without distortion for use with wideband instruments, such as the Models TR8828D and TR8818A digitizers.
- **High-density Packaging** - Conditioning of 2 or 6 channels per module give space and cost benefits to multichannel digitizing systems.
- **Flexible Trigger Generation** - Digitally programmable (6103) trigger generator creates a TTL sync pulse from an internal or external level and slope.
- **WAVEFORM-CATALYST Compatible** - Signal conditioners (manual or programmable) incorporated with modular digitizers are all compatible with WAVEFORM-CATALYST Data Acquisition Software for the IBM-PC™.

- **High Voltage Inputs** - Voltages to 50 V can be attenuated to levels appropriate to LeCroy modular digitizers with the Model 6103 amplifier.
- **Cascading Amplification** - High bandwidth and multichannel packaging allow cascading of a signal through two amplifiers with minimal degrading of risetime.

## Functional Description

LeCroy signal conditioning modules are designed for general applications and for matching signals from the test device to the fixed input range of LeCroy modular digitizers. For system versatility the Model 6103 dual channel amplifier offers full programmability of its multiple gain and input options and it provides power-up protection (settings default to high impedance and high voltage input range). The LeCroy 6103 allows both bipolar and unipolar inputs to be matched (via programmable input offset) to the input of the digitizer or other instrument over plus and minus the input sensitivity. Excellent offset stability is maintained on the 6103 via self-calibration performed each time offset, gain or filtering is programmed. Upon power up and after temperature stabilization, offset calibration should be performed to assure best operation.

A low pass filter is selectable under program control in the Model 6103. Thus, undesired frequencies (e.g., unwanted harmonics above the Nyquist limit) can be attenuated. The Model 6103 is shipped with a 20 MHz plug-in filter but the design is user-configurable.

The trigger generator section of the Model 6103 is designed to cover a wide range of input signal conditions and to give flexible control over the conditions of generating a trigger pulse. Selectable trigger source, coupling, level and slope are programmable on the Model 6103.

Should low impedance signals require attenuation only, the Model 8102 with six input channels, provides a cost-efficient solution. Through manual operation, frequencies from DC to 150 MHz can be scaled and the attenuation value read out via computer.



# Modular Digitizer Systems

## 6103 & 8102 Specifications

### 6103 Amplifier/ Trigger Generator

#### INPUT CHARACTERISTICS

**Channels:** 2 single-ended channels; 1 M $\Omega$ /50 pF and 50  $\Omega$  selectable input impedance; AC or DC coupling for 1 M $\Omega$  impedance.

**Sensitivity:** 50 mV p-p to 50 V p-p in 10 ranges for 1 M $\Omega$  inputs, 50 mV p-p to 5 V p-p in six ranges for 50  $\Omega$  inputs, to provide 0.5 V p-p at output (TABLE 1); gain accuracy 3% of full scale; total harmonic distortion (to 50 MHz) is <-40 dB.

**Offset:** Programmable over  $\pm$  full input range in 0.4% increments. Built-in auto-calibration provides error correction; should be performed after system warm-up and stabilization.

**Frequency Response:** DC to 150 MHz (-3 dB) for 50  $\Omega$  inputs; DC to 100 MHz (-3 dB) for 1 M $\Omega$  input; with bandwidth limit ON, 20 MHz (-3 dB).

**Risetime:** 50  $\Omega$  input < 2.5 nsec, 1 M $\Omega$  input < 3.5 nsec.

**Overshoot:**  $\leq$  5% for input pulse risetime  $\geq$  3 nsec.

**Recovery Time:** Recovers to 1% from x2 overdrive in  $\leq$  10 nsec

**Input Protection:** Maximum safe input voltage at 1 M $\Omega$  is 250 V (DC + peak AC), at 50  $\Omega$  is 5 VDC (500 mW) or  $\pm$ 10 V peak AC or 50 V peak for 10  $\mu$ sec transient.

#### OUTPUT CHARACTERISTICS

**Nominal Full Scale Output:**  $\pm$  250 mV nominal ( $\pm$  300 mV linear range)

**Output Impedance:** Matched to 50  $\Omega$  loads.

**Noise:**  $\leq$  2 mV RMS at output.

**Channel-to-Channel Isolation:** A to B, < 40 dB at 100 MHz with both at same sensitivity setting (B to A is slightly higher).

#### TRIGGER GENERATOR

**Source:** Amplifier channel A, B, external, external/10; trigger bandwidth DC to 100 MHz; slope selectable, + or - ; external trigger input impedance 1 M $\Omega$ ; coupling selectable as DC, AC, LF reject, HF reject.

**Level:** External, -2 V to +2 V; external/10, +20 V to -20 V; channel A or B, + to - 2x full input range setting. Settable in all cases in 0.4% increments; DC level accuracy +10% of full scale.

**Trigger Output:** Two TTL 50  $\Omega$  outputs allow triggering two LeCroy waveform recorders; maximum propagation delay 35 nsec; output width 50 nsec.

#### GENERAL

**Connectors:** All front-panel connectors are female BNC.

**Control:** All functions programmable and readable via Dataway.

**Module ID:** Upon query from controller, module returns "6103" as identification.

Gain/attenuation vs. max. input to generate digitizer full scale level (500 mV):

$GAIN = \frac{V_o}{V_i}$	6103	Acceptable Ranges 8102
100	-	-
50	-	-
20	-	-
10	50 mV	-
5	100 mV	-
2	250 mV	-
1	500 mV	500 mV
.5	1.0 V	1.0 V
.2	2.5 V	2.5 V
.1	5.0 V	5 V
.05	10 V*	10 V
.02	25 V*	-
.01	50 V*	-

\*1 M $\Omega$  only

TABLE 1  
Gain/Attenuation

### 8102 6 Channel Step Attenuator

#### INPUT AND OUTPUT CHARACTERISTICS

**Channels:** 6 independent channels; manual control on front panel; input and output impedance 50  $\Omega$ .

**Frequency Response:** DC to 150 MHz; rise and falltime 2 nsec.

**Input Ranges:** Five attenuation settings 1, 2, 5, 10, 20 on each channel; accuracy 4%.

**Input Protection:** Maximum safe input 10 V on 20x attenuation range or 50 V for  $\leq$  1 msec or 250 V for  $\leq$  10  $\mu$ sec transient.

#### GENERAL

**Connectors:** Inputs and output connectors are isolated Lemo female. Grounds isolated channel to channel and channel to chassis (earthground).

**Control:** All range settings manually controlled; range of each channel can be read out by computer.

### Specifications Common to Both 6103 & 8102

#### POWER REQUIREMENTS

Modules require power as follows (use LeCroy 8013A, 1434A or 8025 Mainframes).

Model No.	+6 V	-6 V	+24 V	-24 V
6103	1.8 A	800 mA	550 mA	350 mA
8102	140 mA	-	-	-

#### GENERAL

**Environment:** Proper operation of above modules requires +15°C to +25°C intake air with sufficient airflow to maintain temperature rise of exhaust air to <15°C (+30°C intake air allowed if sufficient airflow to maintain temperature rise of exhaust air to <10°C). Operating humidity range up to 90% relative humidity non-condensing at +25°C. Operating altitude < 10,000 ft. above sea level (< 3,045 m) Non-operating temperature range is -10°C to +50°C.

#### PACKAGING

RF-shielded modules in conformance with the CAMAC (IEEE-583) Standard

Model	Size	Height	Width	Depth
6103	1	221 mm	17 mm	292 mm
8102	3	221 mm	51 mm	292 mm

#### ORDERING INFORMATION

MODEL NO.	DESCRIPTION
Model 6103	150 MHz Programmable Dual Amplifier/Trigger Generator
Model 8102 DLE-6	150 MHz Hex Step Attenuator - 6-Ft. Twisted-pair Cable with Differential Lemo Connector
LE/BC-6	6-Ft. RG174 Cable Lemo-BNC
LE/LE-3	3-Ft. RG174 Cable Lemo-Lemo



## 5612 & 5613 Fiber Optic Analog Transmitter and Receiver

### Main Features

- **Bandwidth from DC to 1 MHz** - Accommodates a variety of frequencies without blocking baseline data. Especially useful for transmission of high voltage phenomena.
- **Wide Input Range from  $\pm .2$  V to  $\pm 100$  V** - Full scale input voltage range extends from .2 V to 100 V in 1, 2, 5 sequence.
- **Wide 54 dB Dynamic Range** - A signal-to-noise ratio of 54 dB typical and 48 dB guaranteed allows transmission of analog signals with 9-bit resolution. This resolution, in conjunction with the linearity and DC stability of the overall system makes the Model 5612 and Model 5613 ideal solutions to applications requiring highly accurate signal transmission on fiber optic cabling.
- **Dual Channel Receiver** - In order to provide maximum cost effectiveness, the Model 5613 Receiver has been designed to be dual channel, reducing the cost per channel of the overall link system.
- **Excellent DC Stability** - The Model 5612 and Model 5613 have been designed to provide very high DC stability in order to eliminate the need for tedious and inaccurate calibration adjustments to compensate for changes in ambient conditions.
- **High EMI Immunity** - The 5612 Transmitter is designed to operate in adverse EMI environments.

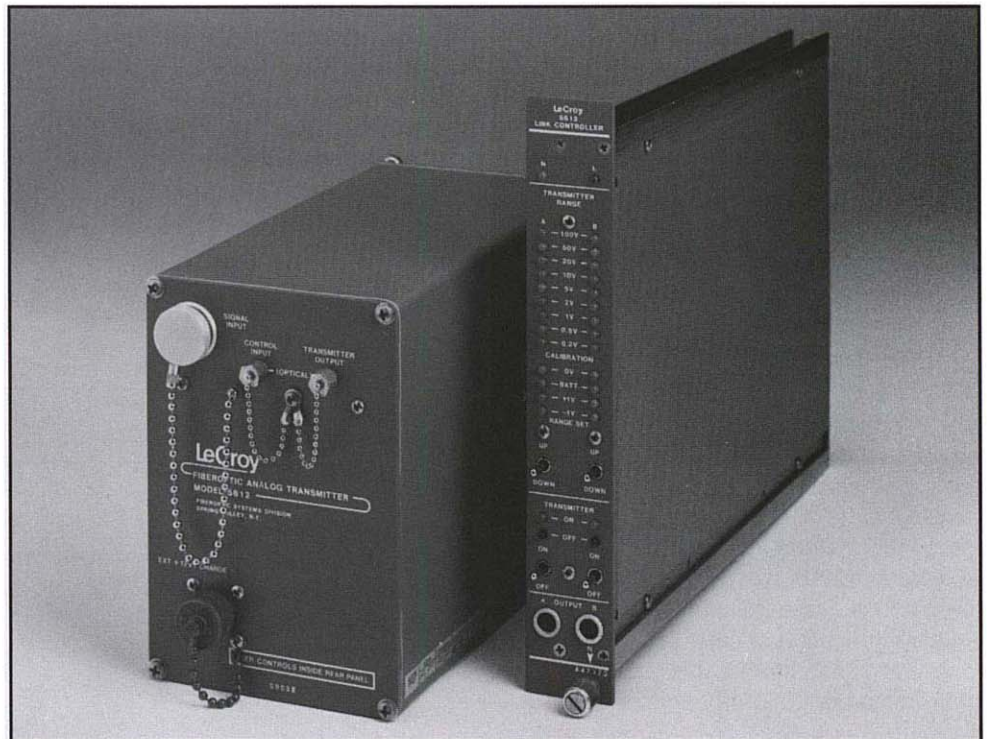

- **Battery Powered Transmitter** - Since the Model 5612 Transmitter is battery powered it may be connected directly to the device on which a measurement is being made. This allows it to float at the potential of the device under test, providing it with the ability to measure even very small signals (200 mV full scale) riding on very high common mode potentials.
- **Built In Charger** - A built in battery charger and AC adapter cord are provided with each Model 5612 Transmitter. This, in conjunction with the remote battery test feature and the ability to remotely turn the transmitter on and off, allows for operation in applications where the transmitter must be placed in locations which are not easily accessible for long periods of time.
- **Local/Remote Control** - All functions can either be set by front-panel switches on the Receiver module or controlled via an IEEE 583 (CAMAC) interface by computer such as an IBM PC, DEC Microvax, or others.



# Modular Digitizer Systems

## Functional Description

LeCroy optical analog links are suitable for a variety of applications where it is difficult or hazardous to change transmission conditions once a test has begun. Electric power line monitoring, high current testing, EMP testing, weapons simulation experiments, EMC testing, fusion research, high energy physics, and high explosive research are just a few examples of this type of application. The Model 5612 Transmitter and Model 5613 Receiver feature a dual fiber interface which bi-directionally links the transmitter and the receiver. Signal data is transferred from the transmitter to the receiver on one of the optical fibers and control data is transferred from the receiver to the transmitter on the other fiber. This two-fiber system allows for remote verification of calibration, remote control of transmitter input signal range, and remote control of transmitter on/off status.

The Model 5612 enclosure has been designed to operate in high EMI environments. Signal integrity is maintained even in the presence of electromagnetic fields and ground potential variations. Figure 1 illustrates a typical application in which the Model 5612/5613 system might be utilized.

Transmission of data on the signal fiber utilizes an FM modulation technique to allow for frequency response from 1 MHz all the way down to DC. A typical signal-to-noise ratio of 54 dB, guaranteed 48 dB, makes this link suitable for applications which require 8- or 9-bit digital resolution. Automatic Gain Control provides ease of operation by automatically compensating for fiber attenuation and other factors influencing the attenuation of the transmission media.

The Model 5612/5613 link system can typically be used with fibers up to 1 km in length. The stated specifications are applicable for any fiber plant which provides a minimum of 4  $\mu$ W of optical power to the receiver and which has bandwidth in excess of 15 MHz.

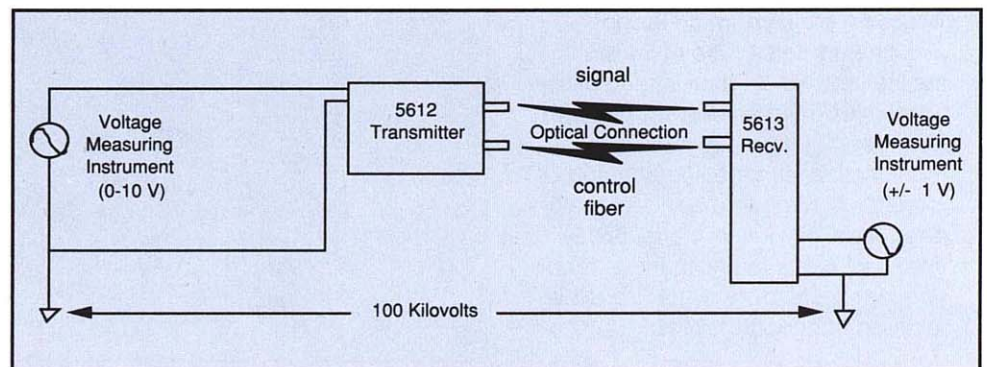

Figure 1



## 5612 & 5613 Specifications

### Transmitter — Model 5612

#### ELECTRICAL SPECIFICATIONS

**Input Characteristics:** Differential Input. Impedance 10 M  $\Omega$   $\pm$  5% shunted by less than 30 pF.

**Full Scale Input:**  $\pm 100$ ,  $\pm 50$ ,  $\pm 20$ ,  $\pm 10$ ,  $\pm 5$ ,  $\pm 2$ ,  $\pm 1$ ,  $\pm 0.5$ ,  $\pm 0.2$  V. Full scale range is programmable by front-panel switches or by CAMAC commands.

**Input Protection:** Spark Gap, Zener and varistor protected input.

**Signal Input Connector:** Front-panel Lemo Female Size 3, triaxial. Mates with Lemo F3.650.NYLS/102 or LeCroy 402 001 650. Fits 0.36-0.4" OD cable such as Belden 9267. LeCroy cable assembly is available as Part No. 480-200-301.

**Fiber optic Connectors:** Two, Amphenol 906 — one for signal transmission and one for remote control. To insure rated specifications Delrin short alignment sleeves should be used on all fiber optic cable connectors. See LeCroy Application Note AN-29 for details.

**Power Switch:** 3-position rear-panel switch selects transmitter internal power, power off, or external power input.

**Local/Remote Control:** Rear-panel slide switch. When set to Local, the transmitter operational status may be manually set at the transmitter. When set to Remote, may be set via the front panel of the receiver or by program commands from the receiver.

**Range Switch:** 16-position rotary switch. Used to set the input range or apply a calibration voltage. Active when the Local/Remote switch is in the Local position.

**Power Consumption:** 250 mA Transmitter ON, 200  $\mu$ A Transmitter OFF.

#### OPTICAL SPECIFICATIONS

**Launch Power (after 30 m of fiber) for both signal and control fibers:**

Fiber Dia. $\mu$ m	Numerical Aperture	Light Power $\mu$ Watt	dBm
100	0.27-0.33	10 - 40	-20 to -14
200	0.27-0.43	40 - 160	-14 to -8

#### MECHANICAL SPECIFICATIONS

**Operating Temperature:** 5°C to +50°C.

**Weight:** 9 lbs.

**Height:** 6 inches.

**Width:** 4 inches.

**Depth:** 8.25 inches.

### Receiver — Model 5613

#### ELECTRICAL SPECIFICATIONS

**Signal Output:** A full scale signal at the input of the transmitter produces  $\pm 2$  V into an open circuit or  $\pm 1$  V into 50 Ohms at the receiver output. A maximum output of  $\pm 5$  V (20 mA) into high impedance ( $\geq 250$  Ohms) is available as an option (MOD201). In addition, an output of  $\pm 10$  V (10 mA) into loads of 1 K Ohms or higher is another option available (MOD300). Front-panel output via twin axial connector with Pin 1 being signal, and Pin 2 being ground. Front-panel connector mates with Lemo FO.302.S/4.2 or LeCroy 402 051 000. Suitable for 0.15-0.165" OD cable such as Belden 88761. LeCroy cable assembly (one connector only) is available as Part number 480 100 201.

**Output Impedance:** 50  $\Omega$ .

**Power Consumption:** 750 mA at +6 V, 110 mA at +24 V, 110 mA at -24 V.

#### OPTICAL SPECIFICATIONS

**Fiber Optic Connectors:** Four Amphenol Model 906 Style connectors mounted at rear of module (2 each for signal transmission, channel A and B, and 2 each for remote control, channel A and B respectively). To insure rated specifications Delrin short alignment sleeves should be used on all fiber optic cable connectors.

**Optical Input Sensitivity:** Typically 4  $\mu$ W for rated specifications, for both signal and control fibers. (10  $\mu$ W guaranteed).

#### MECHANICAL SPECIFICATIONS

**Front-panel Controls and Indicators:** Two LED displays indicate the range setting of the two independent channels A and B. Toggle switches are used to select ranges. Two LEDs indicate transmitter power-on or power-off. An on/off toggle switch is provided for each channel. Diagnostic LEDs indicate when the module is addressed and when its LAM output is asserted.

**Packaging:** In conformance with the international CAMAC standard (IEEE report #583). RF-shielded CAMAC #2 module.

#### SYSTEM CHARACTERISTICS

**DC Stability:**  $< \pm 100$  ppm/°C, Gain  $< \pm 75$   $\mu$ V/°C per week after 30 minute warmup.

**Bandwidth:** DC to 1 MHz typical, 700 kHz guaranteed

**Flatness:**  $< \pm 0.5$  dB (DC to 400 kHz).

**Transient Response:** Rise and Fall times  $< 500$  nsec. Overshoot  $< 5\%$ .

**DC Linearity:**  $< \pm 0.1\%$  deviation from straight line over the full output range.

**AC Linearity:**  $< \pm 3\%$  deviation from straight line over the full output range.

**Signal-to-Noise Ratio:** 54 dB typical, 48 dB guaranteed.

**Full Scale Accuracy:**  $\pm 0.1\%$  ( $\pm 1$  V Input) after warmup.

**Calibration:** Three internally generated reference voltages may be switched across the input of the transmitter. These voltages are +1.00 V, 0.00 V and -1.00 V. If the system gain is set correctly, then these voltages generate +1.00 V, 0.00 V and -1.00 V respectively at the output of the receiver when terminated with 50 Ohms or typically +2.00 V, 0.00 V, and -2.00 V when unterminated. For MOD201 these voltages are +5 V, 0 V, and -5 V into high impedance. For MOD300 these voltages are +10 V, 0 V and -10 V into high impedance.

**Battery Voltage Check:** The transmitter can be instructed manually or via the controlling computer to connect its battery terminals to the signal input. An output of  $\geq 1.5$  V into high impedance or  $\geq 0.8$  V into 50  $\Omega$  indicates the battery is charged.

**Manual/Computer Control:** The full scale input range, calibration signal, battery test and the transmitter on/off status can be set by front-panel switches on the receiver module, or can be programmed via an IEEE 583 (CAMAC) interface.

Decimal Value On Write Lines	Transmitter Setting Mode
0	100 V
1	50 V
2	20 V
3	N/A
4	10 V
5	5 V
6	2 V
7	N/A
8	1 V
9	0.5 V
10	0.2 V
11	N/A
12	GroundReference
13	Battery Voltage
14	+ Calibration
15	- Calibration

Table 1



# 2323A Dual and 4222 Quad Gate and Delay Generators

Gate and Delay Generators are designed to provide precisely timed logic windows and level transitions. Applications employing Gate and Delay Generators may require that a logic transition occur immediately and have a given duration. Others require that a delay elapse prior to the logic transition, or that a precise gate be generated after some fixed delay. All these functions of Gate Generator, Delay Generator, and Delayed Gate Generator are performed by any LeCroy Gate and Delay Generator module.

## Main Features

**Gate, Delay, and Delayed Gate Functions** - Multiple functions provide flexible adaption to varied system requirements.

**Manual and/or CAMAC Programmable Options** - Continuous manual control and high resolution programmable digital delay adjustment are selected by choice of modules.

**Minimum Deadtime** - Any of these Gate and Delay Generators may be re-triggered immediately after the delay has elapsed.

**Delayed Outputs** - At the end of any gate, a delayed output issues a pulse.

**Independent Gate and Delay Functions** - Each LeCroy Gate and Delay Generator provides precision gate lengths which can be used as a precision delay as well. The 2323A has two such gate generators. One can be used

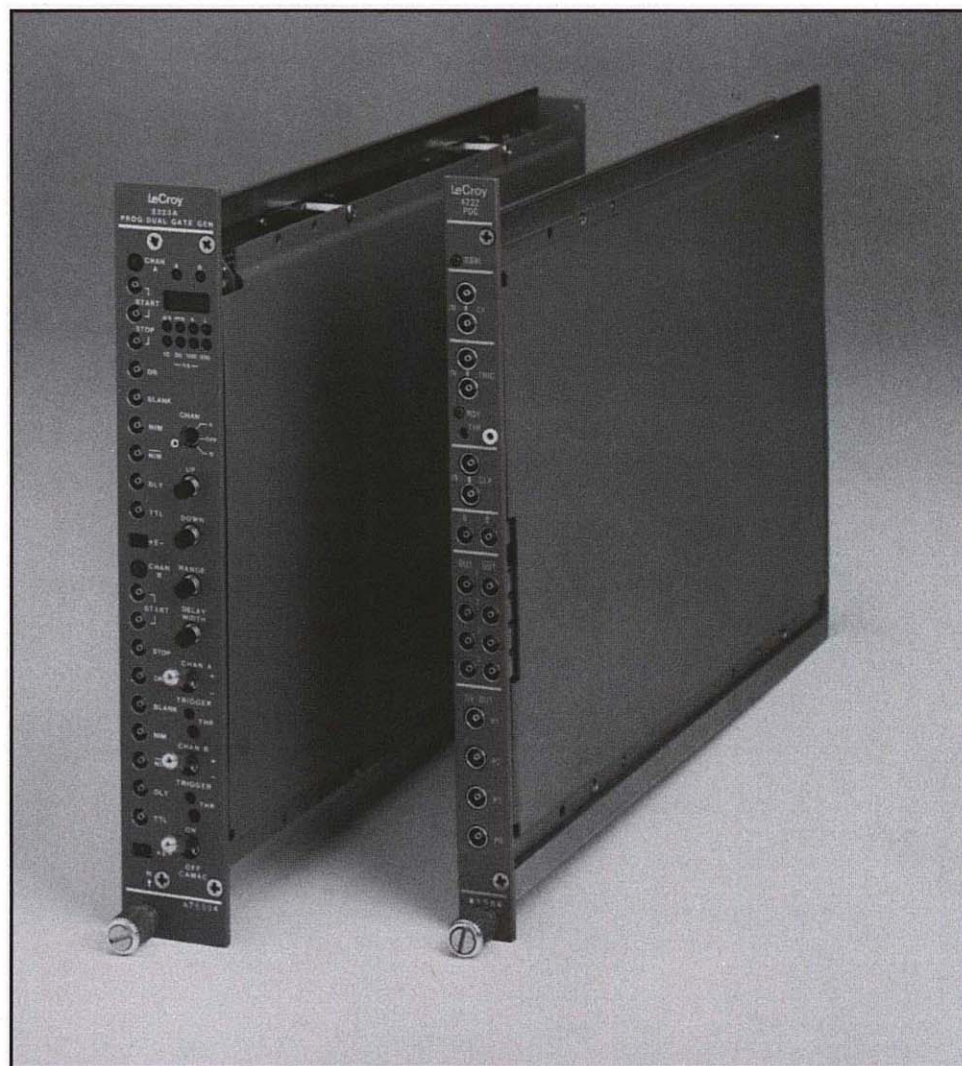

as a delay which starts the second generator that provides the gate signal.

**NIM, TTL, and ECL Level Compatibility** - Convenient output levels allow adaptation to a variety of system configurations.

**Wide Dynamic Ranges With High Resolution** - Ranges from under 100 nsec to 10 sec are provided by the Model 2323A. Model 4222 maintains 1 nsec resolution up to its range of 16.7 msec.



## Functional Description

LeCroy Gate and Delay Generators allow both manual and/or CAMAC programmability for gate durations ranging from a few nanoseconds to several seconds. CAMAC IEEE-583 (see LeCroy Application "The CAMAC Standard") is employed for the Models 2323A and 4222.

Each of these modules has its own unique advantages that enhance its service in certain applications. For example, Model 2323A has an ECL output for compatibility with a wider variety of input requirements. Model 4222 has four time generators in a single-width module, making it a superior choice in high-density systems where space is at a premium.

Arbitrary gate widths are provided for in the Model 2323A via a latch-mode operation where the gate duration is determined by externally applied START and STOP signals. Further versatility is incorporated into this module by including a delayed output pulse which occurs at the end of each gate output pulse and has a preset width.

### MODEL 2323A DUAL GATE GENERATOR TIMING DIAGRAMS

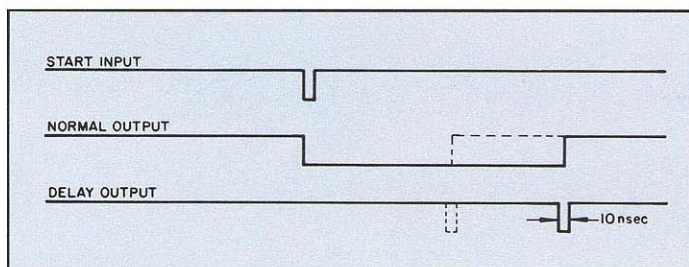

*Presettable Width Mode*

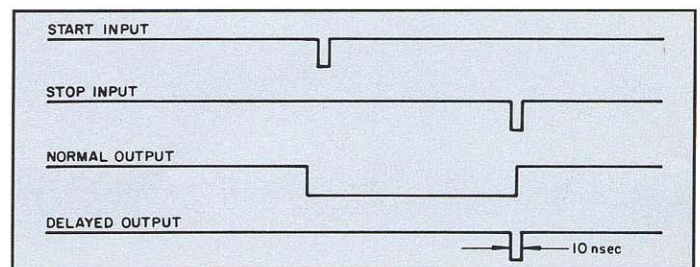

*Latch Mode*

Precision delayed gates can be produced with any LeCroy Gate and Delay Generator module. Gate signals can be used to set coincidence time windows, provide veto signals, or generate fast clear signals after some preset delay. Latch Mode operation, available in the Model 2323A, permits gating-off front-end electronics after receipt of a valid trigger signal and maintaining this state until data acquisition is complete.

Since the 2323A Gate and Delay Generator module has two independent generators, one generator can be used as a precision delay. A delayed output pulse, occurring at the end of the gate pulse, is applied to the START of a second generator. The second generator then produces a precision pulse that is delayed by the first generator.

Delayed gate operation of the Model 4222 is provided by side-panel accessible switches which couple two channels together, providing either one or two gate generators.

### MODEL 2323A

LeCroy's CAMAC Model 2323A is a fully programmable Gate and Delay Generator packaged with two channels in a double-width CAMAC module. Its Gate duration is programmable over the range 100 nsec to 10 seconds, covering a dynamic range of eight orders of magnitude. Moreover, outputs as short as 50 nsec can be selected at the expense of accuracy and stability. All settings may be programmed under CAMAC control or via front-panel controls. As the settings of the instrument are battery backed-up, the unit does not have to be reprogrammed after turning the crate OFF/ON after a power failure. The Model 2323A offers excellent stability and jitter properties with 0.2% of Full Scale accuracy in the gate setting.

The Model 2323A offers both START and STOP inputs. This allows the output pulse width to be determined by the START-STOP time difference in the latched mode or by the internal timer in the preset mode. A Blanking NIM input causes a notch to be taken out of the gate, equal in duration to the Blanking input. This is especially useful to gate off data acquisition during spurious periods.



---

# Modular Digitizer Systems

---

Conversely, a NIM OR input causes all outputs to be set to TRUE for the duration of the OR inputs.

The unit offers normal NIM and complementary NIM outputs equal in duration to the gate width selected. In addition, a DELAY output is produced at the edge of the Gate pulse. The Model 2323A also provides a differential ECL output and a TTL output capable of driving a bin gate on a NIM bin. Both the ECL and TTL outputs may be driven from either the Gate or Delay circuit. These options are selected by board-mounted shorting plugs.

The Gate duration and the width of the Delayed output are both programmable under CAMAC control. Each of the two channels are programmed independently. All values which are loaded into the Model 2323A may also be read back via CAMAC. Programming the delay involves a 10-bit "mantissa" and a 3-bit "characteristic".

The START input is normally configured to accept NIM signals. A bridged high impedance input is employed to allow

the trigger of more than one channel of 2323A. The front end of the START input consists of a comparator circuit, factory adjusted to trigger at  $-400 \pm 50$  mV. A front-panel accessed multiple turn potentiometer allows the user to adjust the threshold over the range -3 V to +3 V. This allows the unit to be triggered by NIM, ECL, TTL or other standard logic signals. A front-panel accessed switch selects either the positive-going or negative-going edge as the trigger. The STOP input accepts NIM standard pulses.

## MODEL 4222

The LeCroy Model 4222, Quad, Wide Range, Gate and Delay Generator, produces long, precise time delays and time intervals synchronously with a random trigger input. All four channels of the Model 4222 are started by a common trigger input. Each channel provides a programmable time delay of up to 16.7 msec in 1 nsec increments. All programming is under CAMAC control.

The Model 4222 may be set to Retrigger Mode (side-switch selectable) permitting

the unit to retrigger without being reloaded. In Retrigger Mode, a second side-switch permits two options:

- 1) Retrigger before end of delay; and
- 2) Retrigger after end of delay (see timing diagrams on specifications page.)

The unit may be retriggered any time 100 nsec after the last trigger, or any time after the longest delay has elapsed.

Synchronization of many Model 4222 Gate and Delay Generators is possible. An external clock may be used to feed several Model 4222 modules with an identical time-base. Stability and accuracy are then determined by the external clock.

Three outputs are provided for each channel. One output provides NIM-level signals which go "True" after the programmed time delay and is reset by the Clear. Another output gives complementary NIM logic output. Each channel has a corresponding delayed pulse output that provides a 5 V fast risetime signal into 50 Ohms occurring after the programmed time delay.



## 2323A & 4222 Specifications

### 2323A

#### GENERAL

**Packaging:** Double-width CAMAC  
**START Input:** -3 V to +3 V  
**STOP Input:** NIM (0 = 0 V, 1 = -0.8 V into 50 Ω)

**OR Input:** To mix external signal with output gate.

#### GATE WIDTH

**Range:** 100 nsec to 10 seconds or Latch Mode  
**Jitter:** < 0.3% of setting  
**Accuracy:** ± 0.2% of full scale  
**Resolution:** 0.1% of full scale Input to Output  
**Delay:** 24 nsec

#### STANDARD OUTPUTS

**NIM:** One per channel (0 = 0 V, 1 = -0.8 V into 50 Ω, or -16 mA)  
**NIM Complement:** One per channel (0 = -0.8 V into 50 Ω or -16 mA; 1 = 0 V)

#### DELAYED OUT

**Width:** 10, 30, 100 or 300 nsec  
**Occurs:** Trailing edge of gate pulse  
**Risetime:** 2 nsec max.  
**Signal:** NIM (-16 mA)

#### ADDITIONAL OUTPUTS

**TTL:** FET open drain output (+35 V Max, 250 mV, 0.5 W Max)  
**ECL:** Differential ECL (-0.8 V and -1.6 V)  
**TTL/ECL**  
**Select:** Via internal jumpers to correspond to either the NIM or DELAYED outputs or their complements.

#### POWER REQUIREMENTS

**Power Consumption:** 21.6 W  
 + 24 V/-24 V + 50 mA/-75 mA  
 + 6 V/-6 V + 1.8 A/-1.3 A

### 4222

#### GENERAL

**Packaging:** Single-width CAMAC  
**START Input:** -1.5 V to +1.5 V  
**STOP Input:** NIM (Clear input)

#### GATE WIDTH

**Range:** 1 nsec to 16.777215 msec  
**Jitter:** 150 psec RMS Max.  
**Accuracy:** ± 200 psec ± time base error  
**Resolution:** 1 nsec  
**Input to Output Delay:** 170 nsec typical

#### STANDARD OUTPUTS

**NIM:** One per channel. Goes true (-16 mA, or -0.8 V into 50 Ω after programmed time delay. Reset by "Clear".  
**NIM Complement:** One per channel. Normally -16 mA, goes to 0 mA after programmed time delay. Reset by "Clear".

#### DELAYED OUT

**Width:** 100 nsec ± 10%  
**Occurs:** At end of programmed delay  
**Risetime:** 1 nsec  
**Signal Level:** +5 V into 50 Ω

#### POWER REQUIREMENTS

**Power Consumption:** 26.9 W  
 + 24 V/-24 V + 40 mA/-130 mA  
 + 6 V/-6 V + 1.3 A/-2.5 A

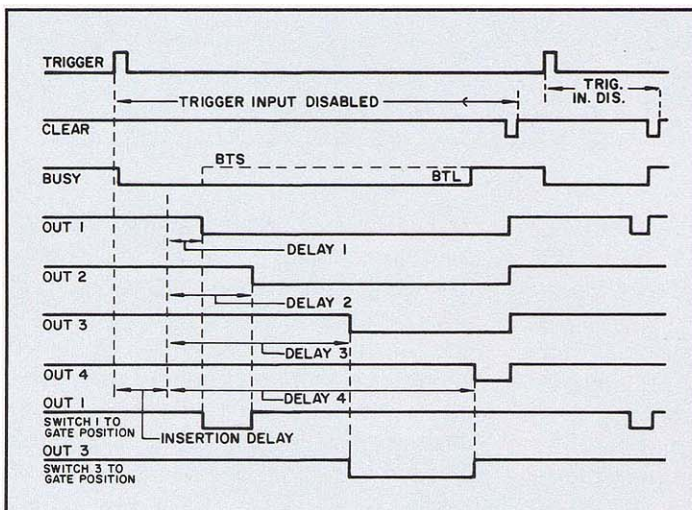

Non-Retrigger Mode

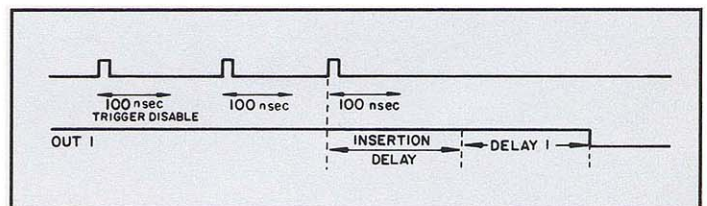

Retrigger before End of Delay - Model 4222

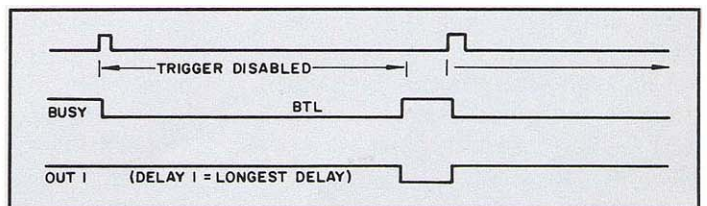

Retrigger after End of Delay - Model 4222



## 6128 Fan-Out and Level Adaptor

### Main Features

- Useful for synchronizing 8818A clocks or 8828D triggers for multiple channel applications
- 100 MHz Bandwidth
- Choice of dual channel 4-fold or single 8-fold Fan-Out
- Input level selectable over  $\pm 2$  V
- Input impedance selectable as Hi Z, 50 Ohms or ECLine 100 Ohm differential
- Single-ended ECL outputs with open emitters or internal pulldowns for 50  $\Omega$  or Hi Z loads

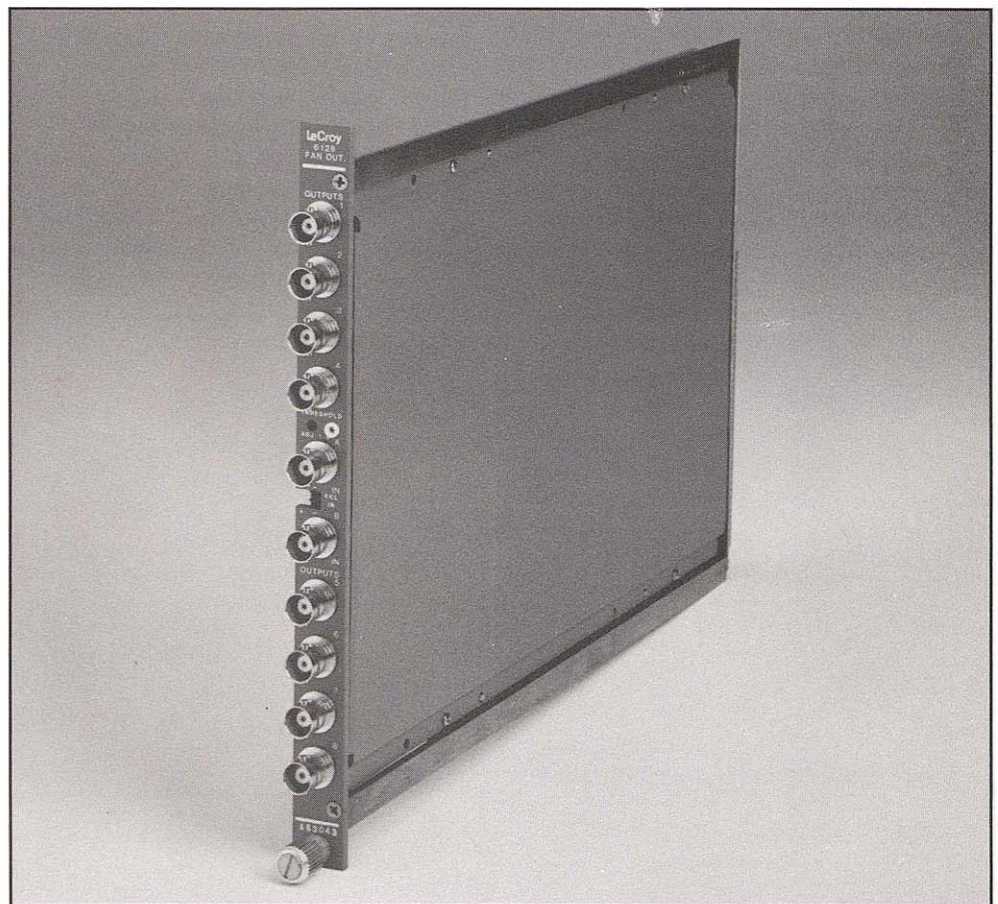

The Model 6128 is a high-speed general purpose ECL logic Fan-Out that is especially useful in distributing a common stop trigger and/or external clock train to several high-speed transient recorders. It can be configured as either a single-input with eight outputs or as two inputs, each with four outputs.

All eight outputs are single-ended ECL levels capable of driving 50 ohm inputs terminated either to ground or -2 V. Output widths are equal to the time over threshold of the respective input. When used in the single-channel eight output mode, the two inputs can be used to perform a logical OR (with positive threshold levels) or AND (with negative logic thresholds).

The inputs may be programmed via side-panel jumpers for options of TTL, ECL (both single ended and ECLine compatible), or adjustable levels ( $\pm 2$  V) with choices of terminations (including high impedance). A front-panel potentiometer is used to determine the adjustable threshold level of either input and can be monitored via front-panel test points.



## 6128 Specifications

### INPUT CHARACTERISTICS

**Configuration:** Each of two channels has choice of one BNC and one differential ECLLine compatible input connector. The connector choice is determined by side-panel accessible patch links. Unit can be operated as two independent 4-output channels or as a single-channel 8-output unit. The latter mode allows the two inputs to be used to logically OR positive going signals or logical AND negative going signals; if only one input is used, the unused input should have its side-panel termination set with  $51\ \Omega$  to  $-2\ \text{V}$ .

**Threshold:** Side-panel patch link (common to all inputs) allows choice of levels to accept TTL (+ 1.2 V threshold), ECL (- 1.2 V threshold) or adjustable (+ 2 to - 2 V threshold). Signal must exceed level setting by 100 mV. Front-panel test point provides voltage reference to monitor threshold level.

**Impedance:** Side-panel patch links (one per input) allow choice of  $51\ \Omega$  to  $-2\ \text{V}$  (for use with open emitter ECL), high impedance (greater than  $1\ \text{M}\Omega$ ), and  $100\ \Omega$  differential (for use with ECLLine compatible connector). All impedances are  $\pm 5\%$  for inputs not exceeding  $\pm 2.5\ \text{V}$ .

**Protection:**  $\pm 5\ \text{V}$  DC continuous, 50 V peak (applied for less than 1 msec with duty factor not exceeding 10%).

### OUTPUT CHARACTERISTICS

**Configuration:** Eight BNC output connectors.

**Level/Width:** All outputs provide single-ended ECL logic levels ( $-1.6\ \text{V}$  low level,  $-0.8$  high level). Output width is equal to time over threshold (i.e., low level is present when input level is below input threshold and high level is present when input level is over threshold).

**Drive:** Internal pulldown resistors provide enough current to drive  $50\ \Omega$  loads to ground. Side-panel patch link (common to all outputs) allows open emitter operation when external  $50\ \Omega$  load is tied to  $-2.0\ \text{V}$ .

**Bandwidth:** 100 MHz

**Rise/Falltime:** Approximately 3.5 nsec.

**Propagation Delay:** Approximately 7 nsec.

### GENERAL

**Controls:** All operating parameters are manually set via side-panel accessible patch links (except threshold level whose screwdriver adjusted potentiometer and test point are mounted on front panel).

**Packaging:** In conformance with the CAMAC standard for instrumentation modules (IEEE Standard 583, European Esone Report EUR4100). RF-shielded CAMAC #1 module.

**Operating Temperature:** Ambient operating range to maintain specifications  $+10^\circ\text{C}$  to  $+30^\circ\text{C}$ .

**Storage Temperature:**  $-10^\circ\text{C}$  to  $+50^\circ\text{C}$

**Power Requirements:**

100 mA at +6 V
550 mA at -6 V
10 mA at +24 V
10 mA at -24 V

Specifications subject to change



## 6010 Controller

### Main Features

- Averaging for waveforms recorded with LeCroy 6880B, 8828D, 8818A, and 6810 digitizers
- Averaging to > 800 waveforms/second; to 8,192 points/waveform
- GPIB or RS-232C control and data transfers at up to 600 kbyte/sec.
- Manual control for LeCroy 6880B waveform digitizers
- CAMAC dataway status display
- Optional 6910 Custom Analysis Software Package

### General

The Model 6010 Manual and Automatic General-purpose Interface to CAMAC (M.A.G.I.C.) controller provides remote control of LeCroy waveform digitizers and other CAMAC instrument modules. A host computer can set up the instruments and read back data via simple English-like commands. The host can communicate to the 6010 across either the IEEE-488 bus or RS-232C lines.

The 6010 also provides high-speed real-time signal averaging of digitized waveforms. Up to 8,192 samples of digitized waveform data can be retrieved from LeCroy 8828D, 8818A, or 6810 waveform digitizers and averaged. The 6010

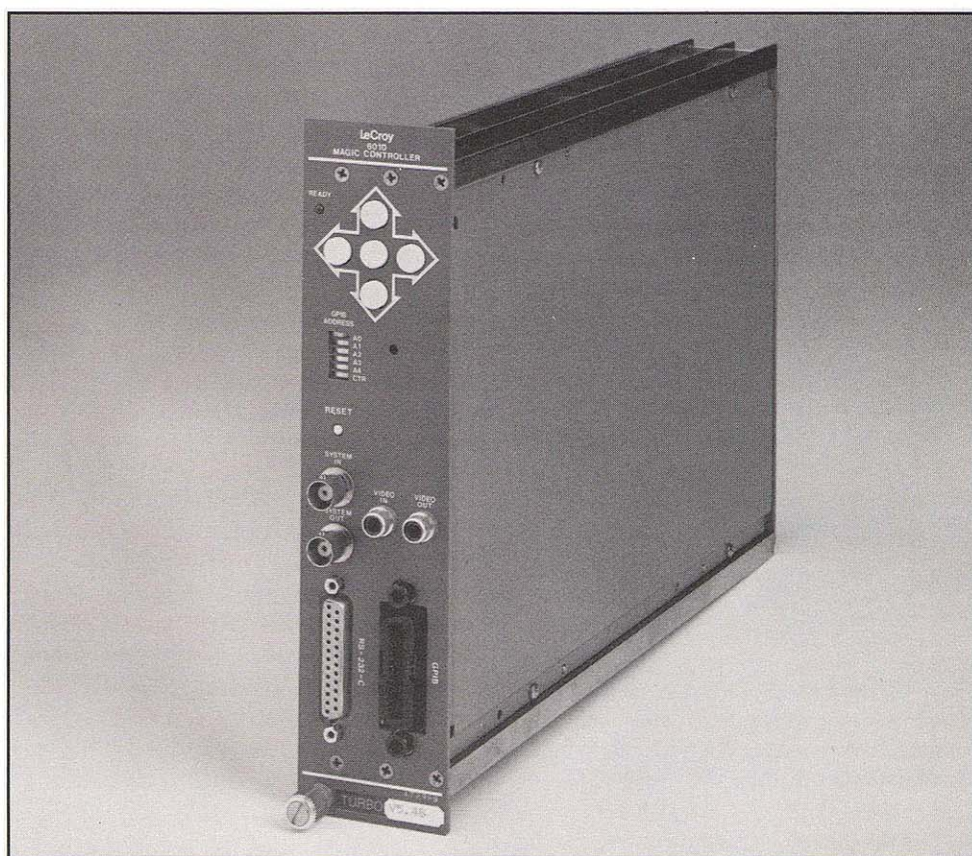

can simultaneously average waveforms from any combination of these digitizers. The optional 6910-EXE software package adds averaging for a single 6880B digitizer on up to 1,348 sample waveforms.

### INSTRUMENT CONTROL

The Model 6010 Manual and Automatic General-purpose Interface to CAMAC controller provides remote control of LeCroy waveform digitizers and other

CAMAC instrument modules. The 6010 accepts setup commands from a host computer, a terminal, or from front-panel manual inputs. The host computer or terminal can communicate via either the IEEE-488 Standard Interface Bus or RS-232C serial lines.

The 6010 interprets English-like setup commands, translates them, and controls the addressed CAMAC module using the CAMAC standard format. This standard format (N,F,A,data) consists of



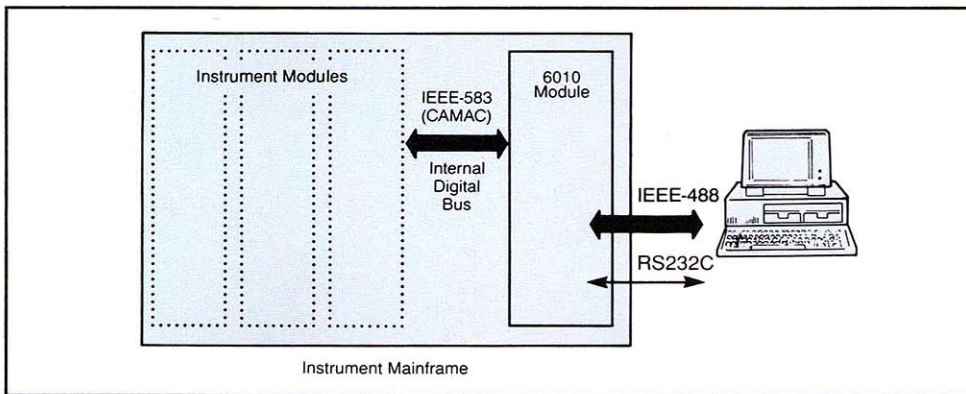

Waveform digitizing system with 6010 interface/averager.

the module slot address (N) within the mainframe, function command (F), sub-command (A), and the data.

The card-edge printed circuit board fingers at the back of the 6010 module connect into the CAMAC dataway (backplane) in a CAMAC crate (mainframe). The 6010 module resides in the three slots, or "stations", furthest right in a CAMAC mainframe. The furthest right slot in any CAMAC mainframe is dedicated for the CAMAC controller. Instrument modules can fill the rest of the mainframe.

## GPIB COMMUNICATION

The 6010 Interface acts as either a Talker or Listener on the IEEE-488 Standard Interface Bus (GPIB). Thus, any GPIB controller can configure, read data from, or write data to any CAMAC instrument module. A standard GPIB connector on the front panel permits easy interconnection to any GPIB system.

As an IEEE-488 Listener, the 6010 accepts IEEE-488 Bus commands and translates them into CAMAC dataway commands. As an IEEE-488 Talker, the 6010 takes single readings or blocks of data from a CAMAC instrument module, transfers them across the CAMAC dataway, and then out across the GPIB. Any GPIB instruments assigned as Listeners by the GPIB controller (e.g. printers, tape drives, or the controller itself) can accept this data from the GPIB. A personal computer, mini-computer, mainframe computer, or dedicated instrument controller can function as the GPIB controller.

The 6010 operates either in DMA or non-DMA mode. In DMA mode, the 6010 can transfer data at selectable maximum rates of 300, 400, or 600 kbytes per second. This feature enables the 6010 to match the maximum transfer rates of both fast and ultra-fast GPIB host computers. Actual data throughput rates are host computer dependent.

Each DMA transfer requires that the entire selected block size (max. 8192 bytes) be transferred without any stops longer than 2 msec. The non-DMA mode, offering up to 125 kbytes per second transfers, allows delays from the host between bytes. Therefore, it provides an ideal environment for GPIB program development.

The 6010 can request service (GPIB SRQ line) on a variety of conditions including waveform averaging complete, 6880B digitizer calibration complete, and end of data transfer (waveform digitizer memory empty).

## BIDIRECTIONAL RS-232-C COMMUNICATION

The 6010 can accept instrument control commands and transfer data via RS-232C serial communication. Primary RS-232C functions are "soft" selectable via either GPIB or the five front-panel buttons in conjunction with a video monitor. These functions consist of baud rate, number of data bits, number of stop bits, parity, and hand-shake (RTS/CTS) disable.

## PROGRAMMING

The 6010 setup and data transfer commands are English-like ASCII character strings. For example, to address the instrument installed in slot number 8 (CAMAC N line), send the following command across the GPIB or RS-232C:

N 8

As another example, to change the 6880B trigger slope to positive, send the following command:

SLOPE +



# Modular Digitizer Systems

Multiple commands can be strung together, separated by a semicolon. For example, to set up the entire CAMAC bus in one command, send the following command string:

```
N 8;F 16;A 0;W 5;E
```

This example command string writes a value 5 to the instrument module installed in slot 8 using the instrument's function F16 A0.

## MANUAL CONTROL

An operator can manually control operation of up to six 6880B digitizers via the five front-panel buttons. Up to four waveforms can be displayed. The front panel buttons are also used to set 6010 operating parameters, such as RS-232C configuration.

## VIDEO OUTPUT

The 6010 composite video output can display 6880B digitized waveforms, RS-232C operating parameters, and CAMAC dataway status. It drives a standard RS-170 monochrome monitor.

The video monitor displays menus, which let the user manually control up to six 6880Bs, and up to four 6880B channels. The display graticule indicates calibrated vertical gain and offset, time/div, and horizontal position. All channels and control settings are independent.

A video input connector lets the user selectively display waveforms from 6880B waveform digitizers installed in

other mainframes. The video output from a 6010 installed in another CAMAC mainframe can drive the video input of the first 6010. Several mainframes of 6880B digitizers can be cascaded in this fashion. Menus allow selection of any four of the 6880Bs from any of the mainframes for display on the monitor.

The video source for the output monitor can be selected from either the 6010 itself or from the video input connector. A software command switches the video output.

## WAVEFORM AVERAGING

Averaging digitized waveform data can result in improved signal-to-noise ratio and increased amplitude resolution. The 6010 averages data from LeCroy 6880B, 8828D, 8818A, and 6810 waveform digitizers. The 6010 averages 8818A or 8828D waveforms at 250 waveforms/sec and 6810 digitized waveforms at > 90 waveforms/sec for 1024 point long records. The 6010 uses ROM-based firmware for averaging data from 8828D, 8818A, and 6810 digitizers.

For high speed 6880B waveform averaging, a 6910-EXE executable program must be downloaded to the 6010. This optional 6910-EXE software package includes download and command utilities for a PC. With some user programming, these 6880B averaging routines can be downloaded from other computers.

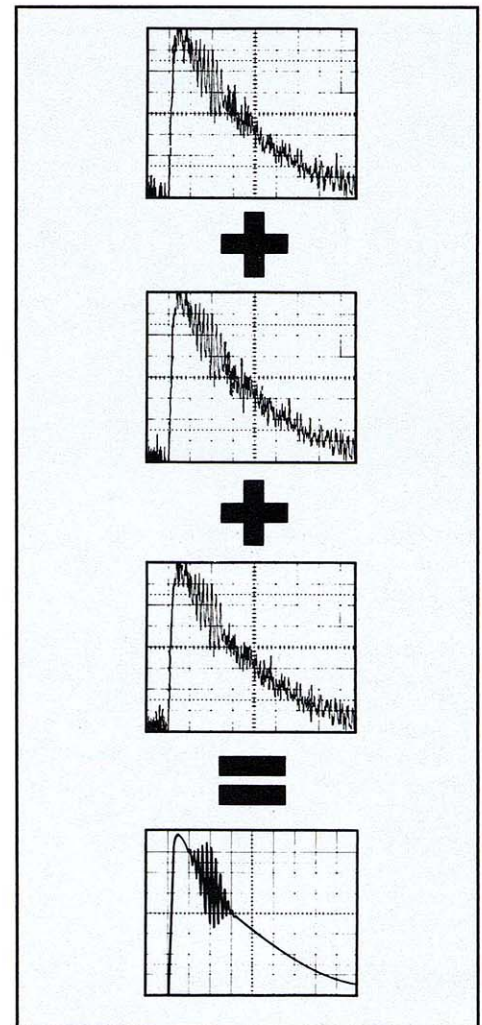

*Averaging waveforms containing asynchronous noise.*



The 6010 uses either summation or exponential averaging techniques. Summation averaging arithmetically adds all the waveform sweeps together, point by point. It then divides each summed point by the total number of sweeps. If the system and waveform noise is random, then the procedure improves the signal-to-noise ratio by the square root of the number of sweeps. Ignoring waveform noise, summation averaging requires a non-changing waveform.

Exponential averaging is useful for removing random waveform noise and viewing the noise-free averaged signal when conditions continuously change. By heavily weighting the most recent sweeps, exponential averaging adapts to changing signals. Exponential averaging gives a much more accurate noise-free waveform picture of changing waveforms than does summation averaging. However, for stable waveshapes, summation averaging removes more noise than exponential averaging.

The 6010 lets the user read out intermediate averaging results. The averaging process can be aborted at any time.

## BATTERY-BACKED SETUPS

The 6010 maintains user setups for both RS-232C ports (A and B), the real time clock, GPIB/RS-232C communications protocol settings, CAMAC settings (N,F,A), and 6880B waveform digitizer setup, display, and acquisition parameters when power is turned off and through line power failures.

## SYSTEM INPUT/OUTPUT

A GPIB Group Execute Trigger (GET) command causes a positive TTL transition on the System Out connector. This output can also be used for custom applications via user-written 6910-DEV downloadable programs. The System In connector is not used by 6010 firmware; it provides a user-definable input for 6910-DEV applications.

## CAMAC DATAWAY DISPLAY

The GPIB/RS-232C "DISPAY ON" command enables the video output to include a CAMAC Dataway display. This display indicates the decimal values (Write and Read data in Hexadecimal for convenience) of the following lines:

- N, F, A, Write data - current settings
- Read data, X, Q - provided after a CAMAC cycle
- LAM status

## REAL-TIME CLOCK

The 6010 real-time clock can be set or read out via the GPIB or RS-232C ports.

## CUSTOM DOWNLOADABLE FUNCTIONS

With the LeCroy 6910-DEV Development Package, users can write custom routines for the 6010. These custom routines can increase application throughput by means of local data analysis and local closed-loop control. The 6910-DEV, which operates on a PC, provides C language or 68020 assembly language development tools including program debuggers, compilers, linkers, loaders, and a 6010 download routine.

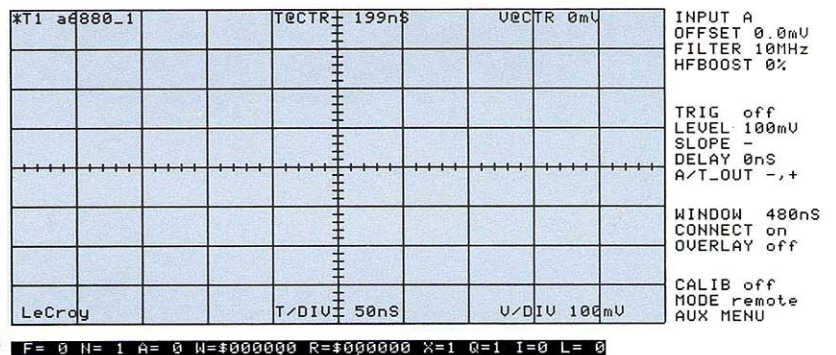



# Modular Digitizer Systems

## 6010 Specifications

### Hardware Specifications

#### PROCESSOR AND MEMORY

**Type:** Motorola MC68020/68881.

**Clock Frequency:** 10 MHz/16 MHz.

**Internal Architecture:** 32-bit data/address registers; 80-bit extended precision floating-point registers.

**Data Bus:** 16-bit asynchronous.

**Real-Time Clock:** Battery backed up; programmable in msec, sec, minutes, hours, day, month, year.

**ROM:** 256 kbytes (operating system).

**RAM:** 512 kbytes plus 2 kbytes battery backed for control settings.

#### GPIO I/O (IEEE-488; IEC-625)

**Type:** Commands conform to IEEE-728 Standard Codes and Formats.

**Transfer Rates:** Software selectable 600, 400, or 300 kbytes/sec max. for each 8 kbyte block in DMA burst transfer mode; Approx 125 kbytes/sec max. in software controlled, non-DMA, block output mode.

#### SERIAL I/O

**Type:** RS-232C, bidirectional on both ports A and B.

**Selectable Parameters:** Baud rate (75 to 19,200 baud), data bits (5, 6, 7, or 8), parity (no, odd, or even), stop bits (1, 1.5, or 2), RTS/CTS handshake enable (on or off).

#### VIDEO OUTPUT

**Supported Instruments:** LeCroy 6880B Waveform Digitizers.

**Type:** Composite video, RS170; jumper selectable for NTSC or PAL formats.

**Resolution:** 512 pixels horizontal; 232 lines vertical.

**Intensity:** 6 levels of gray, including black.

**Graphic Buffer:** 2 pages, 8 discrete planes (16 kbytes each) with up to four planes displayed at a time.

#### VIDEO INPUT

**Type:** Accepts composite video (RS170).

#### SYSTEM OUTPUT

**Type:** TTL level.

**Function:** External sync trigger pulse generated by a GPIB Group Execute Trigger (GET) command.

#### SYSTEM INPUT

Not used by 6010 firmware.

#### GRANT IN, GRANT OUT (Model 6010A only)

**Type:** TTL level.

**Function:** Bus grant signal for Auxiliary Controller Operation.

#### INTERNAL BATTERY

**Type:** Replaceable lithium battery.

**Lifetime:** > 2 years.

**Function:** Power source for real-time clock and battery backed up control settings.

#### POWER REQUIREMENTS

	+6V	-6V	+24V	-24V
6010/6010A	4.5 A	100 mA	200 mA	100 mA

#### ENVIRONMENT

**Operating Temperature:** +5 to +40° C.

**Non-operating Storage Temperature:** -10 to +50° C.

**Operating Humidity:** Up to 90% relative humidity non-condensing at +25° C.

**Operating Altitude:** < 15,000 feet above sea level.

#### PACKAGING

RF-shielded module in conformance with the CAMAC (IEEE-583) Standard.

	Size	Height	Width	Depth
6010/6010A	#3	221 mm	51 mm	292 mm



## Software Specifications

### WAVEFORM AVERAGING

**Type:** Exponential or linear summation.

**Process:** 32-bit integer.

**Maximum Sweeps Averaged:** 1 million - 6880B, 16 million - 8818A or 8828D, 1 million - 6810.

**Number of Points/Sweep:** User selectable from 8 to 8192 for 8818A/8828D digitizers, divided between all channels being signal averaged; user selectable 1024, 2048, 4096, or 8192 for 6810 digitizers, divided between 1, 2, 4, or 8 channels.

**Module Mix:** 6880B - 1 channel alone; any combination of 8828D, 8818A, and 6810 digitizers can be mixed, within the selected number of points/sweep limitation (each 6810 must have at least 1024 points).

**6880B Speed:** > 100 sweeps/sec for 1 usec record; > 150 sweeps/sec for 200 and 500 nsec records; > 300 sweeps/sec for 100 nsec records.

**8818A/8828D Speed:** The following rates are per channel for linear summation averaging. Divide the rate by the number of channels being averaged.

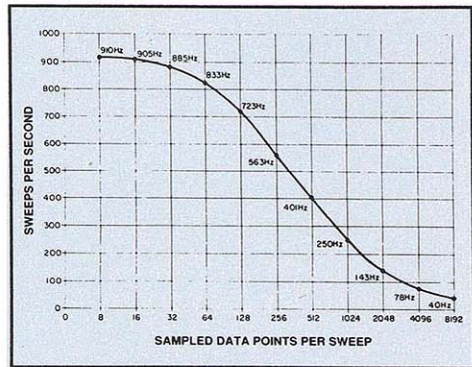

8828/8818 averaging speed with 6010.

**6810 Speed:** The following rates are per channel for linear summation averaging. Divide the rate by the number of channels being averaged.

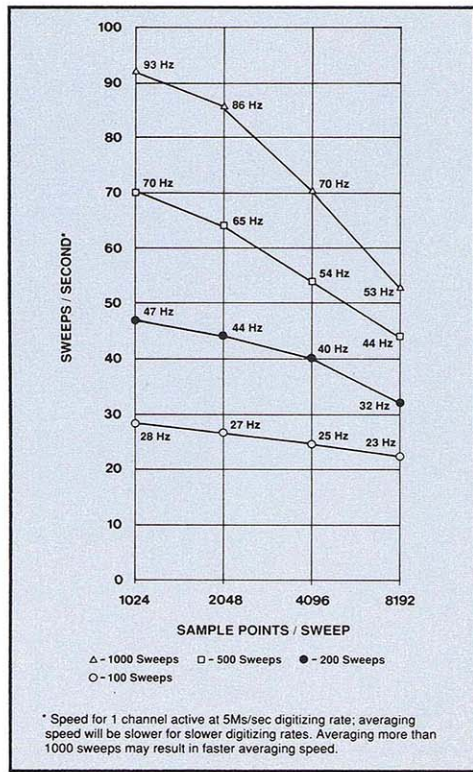

6810 averaging speed with 6010.

### GPIB INTERFACE

**Standard:** Conforms to IEEE Standard 488-1978.

#### GPIB Device Codes Capability:

- SH1 Complete source handshake capability
- AH1 Complete acceptor handshake capability
- T6 Basic talker with serial poll capability and unaddress if MLA (My Listen Address).
- L4 Basic listener with unaddress if MTA (My Talk Address)
- SR1 Full service request capability
- DT1 Capable of responding device trigger
- DC1 Responds to device clear (unaddressed or selective)
- RL1 Full remote local capability (with local lockout)
- C0 No controller capability

**GPIB Address Switch:** Located on the 6010 front panel. The 6010 reads the switch during the power up and after a reset.

### ORDERING INFORMATION

Model Number	Description
6010	General purpose GPIB-to-CAMAC interface, crate controller, and signal averager (includes DC6010 and DC/GPIB cables)
6010A	General purpose GPIB-to-CAMAC interface, auxiliary crate controller, and signal averager (includes DC6010 and DC/GPIB cables)
DC6010	RS-232C cable set (DTE-DCE, DTE with DCE adapter)
DC/GPIB	2 meter GPIB cable
6910-EXE	Downloadable executable programs on a high density 5 1/4" diskette (required for 6880B averaging)
6910-DEV	Developmental package for user-written 6910-EXE programs



## 8901A GPIB to CAMAC Interface

### Main Features

- Controls up to 23 Instrument Modules
- Full GPIB Support
- Up to 450 kbytes/second Data Readout Rate

### General Description

The 8901A translates GPIB commands to CAMAC instrument module setup and readout commands. These CAMAC instruments may be waveform digitizers, preamplifiers, gate/delay generators, time digitizers, event counters, analog fiber optic links, high voltage supplies, or numerous other type modules.

The 8901A GPIB to CAMAC Interface module acts as either a Talker or Listener on the GPIB. Thus, any GPIB controller can program settings, read from, or write to any standard CAMAC module.

As a GPIB Listener, the 8901A accepts GPIB commands and translates them into CAMAC Dataway Bus commands. The 8901A then acts as a controller for the instrument modules installed in the CAMAC mainframe.

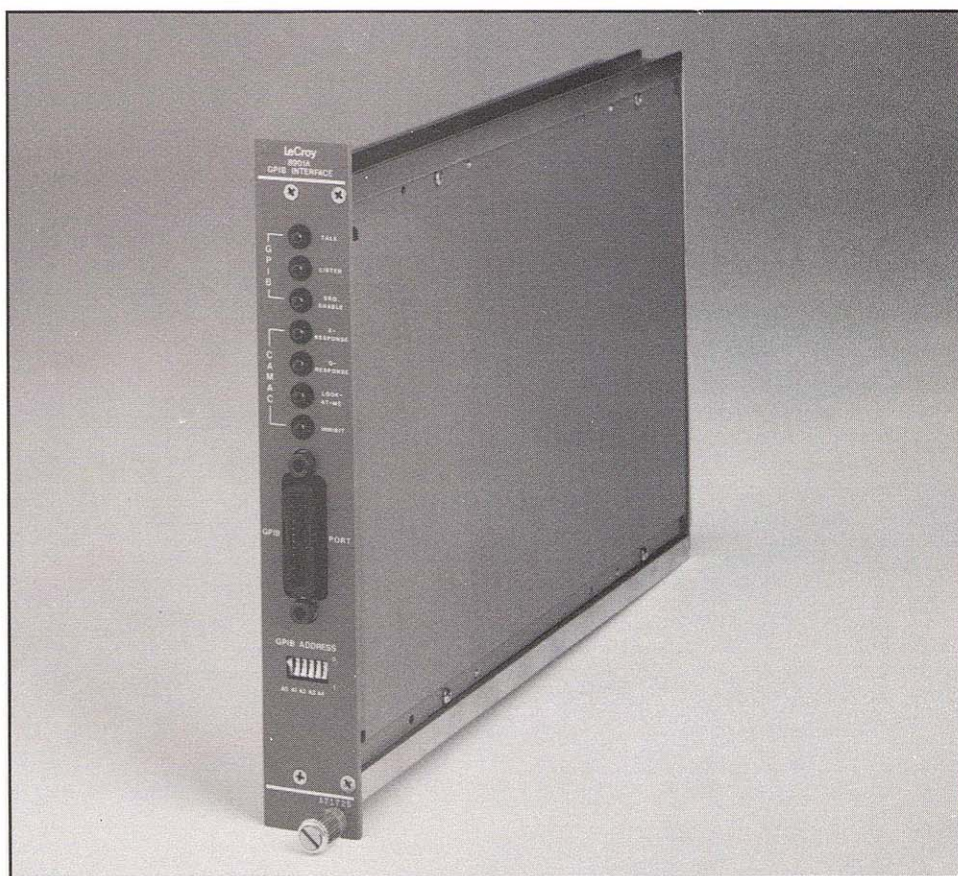

As a GPIB Talker, the 8901A takes single readings or blocks of data from a CAMAC instrument module, transfers them across the CAMAC dataway, and then out across the GPIB. Any GPIB instruments assigned as Listeners by the GPIB controller (e.g. printers, tape drives, or the controller itself) can accept this data from the GPIB.

The 8901A resides in the two rightmost slots furthest right in a CAMAC mainframe. It supports CAMAC Standard command format (F,A,N, data) consisting of Function command (F), Sub-command (A), and module slot address within the chassis (N). The commands use decimal bytes.

CAMAC = Computer Automated Measurement And Control (IEEE Standard 583-1975)  
GPIB = General Purpose Interface Bus (IEEE Standard 488-1982)



## 8901A Specifications

### GPIB INTERFACE (IEEE-488-1978, IEC-625)

**GPIB Device Codes Capability :** SH1, AH1, T6, L4, C0, SR1, RL0, PP0, DC0, DT0, E2

**GPIB Address:** A front-panel DIP switch sets the primary IEEE-488 address of all modular instruments installed in the mainframe.

CAMAC does not support GPIB secondary addressing; an individual module is addressed via its CAMAC slot number (N).

### GPIB Writes (single write mode only):

Four different types of GPIB writes can be executed:

- 1) DATA - module dependent setup commands or output data.
- 2) INITIALIZE (Z) - resets installed modules to their default states. The Initialize command has absolute priority over all other signals or controls.
- 3) CLEAR (C) - clears existing installed module registers.
- 4) INHIBIT (I) - inhibits any CAMAC bus activity (e.g. data transfers or instrument setup changes).

The Data Write applies only to the addressed (by mainframe slot) instrument module.

Clear, Initialize, and Inhibit apply to all modules installed in the CAMAC mainframe.

**GPIB Block Read:** Entire block of data is outputted from a single data request. Data transfer terminates when the CAMAC module memory is emptied (Q=0) or when GPIB host stops requesting data. Optional slow block read mode (for slow modules) adds 40  $\mu$ sec delay between data words.

**GPIB Single Read:** Single read mode is typically used for reading out instrument status, or data from single-reading type devices, such as CAMAC time to digital convertors, event counters, or peak voltage detectors.

Three different single read modes exist:

2 bytes/read - 8 bit data (1 byte) plus CAMAC X/Q byte

3 bytes/read - 16 bit data (2 bytes) plus CAMAC X/Q byte

4 bytes/read - 24 bit data (3 bytes) plus CAMAC X/Q byte

If all the bytes are not read out, they will be discarded during the next CAMAC cycle (when the 8901A is changed from a GPIB Listener to a Talker).

Note: X: Valid and accepted command bit  
Q: Module-dependent response bit (e.g. Q=0 means end of memory for waveform digitizers)

**GPIB Transfer Rates:** 450 kbytes/sec. max. in block read mode. 20 kbytes/sec. max in single read or write modes. Note: Host computer speed and GPIB overhead may reduce throughput.

### GPIB Service Requests (SRQ)

The 8901A asserts the GPIB SRQ line when:

- 1) Module requests attention via CAMAC Look-At-Me (LAM) line
- 2) Module command not accepted or not valid (X)
- 3) Status changes of a selected feature of an addressed module (Q)
- 4) A programmable combination of the above occur.

**GPIB Serial Poll Read:** After a GPIB SRQ, the GPIB controller can poll the 8901A for up to 5 status bytes. These bytes indicate:

- \* If this GPIB address originated the service request,
- \* Which CAMAC module asserted LAM.
- \* The current status of X, and
- \* The current status of Q.

After the GPIB controller reads a status byte, the 8901A terminates the GPIB Service Request.

### GPIB Byte Readout Sequence:

Programmable via hardware jumper for either high byte first or low byte first in 16-bit or 24-bit data readout modes to match the format required by the host computer e.g. IBM (Intel) PC / PS2 host require low byte first; HP controllers (Motorola) require high byte first.

### FRONT-PANEL STATUS INDICATORS LEDs

TALK - 8901A in Talker mode

LISTEN - 8901A in Listener mode

SRQ ENABLE - 8901A enabled to carry out service requests

X RESPONSE - The last command was valid and accepted by the CAMAC mainframe module which the command addressed

Q RESPONSE - A valid data transfer or test occurred within the CAMAC mainframe

LAM (LOOK AT ME) - One of the installed CAMAC modules set a "LAM" (Service Request)

INHIBIT - The CAMAC dataway has been inhibited from activity

### ENVIRONMENTAL

**Operating temperature:** 5 to 40° C

(mainframe cooling must maintain exhaust temperature below 55° C)

**Storage temperature:** -10 to 50° C

**Operating humidity:** 10% to 90% r.h. non-condensing

**Operating altitude:** 0 to 10,000 feet above sea level

**POWER CONSUMPTION:** 1.2 Amps on +6 V supply (7.2 W)

**MECHANICAL:** R.F. shielding in conformance with CAMAC Standard. Must consume the 2 rightmost (controller) slots in CAMAC mainframe.

Height = 221 mm, width = 34 mm, depth = 292 mm

### ORDERING INFORMATION

8901A - Includes 8901A interface module, programming manual, and 2 meter GPIB cable.

DC/GPIB-2 - 2 meter GPIB cable.

6909-1 - IBM PC BASIC software drivers for communicating via National Instruments PC GPIB cards.



# Modular Digitizer Systems

## 6900 Waveform-Catalyst™ PC Software

### CONTROLS UP TO 100 LECROY WAVEFORM DIGITIZERS

WAVEFORM-CATALYST software controls the full spectrum of LeCroy Waveform Digitizer modules. The hardware and software together provide a turnkey, multiple channel, waveform data acquisition system for signals from DC to 500 MHz. WAVEFORM-CATALYST supports simultaneous acquisition on up to 100 waveform digitizer channels.

WAVEFORM-CATALYST sets the digitizing rate, input offset, active memory length, and percentage of pre-trigger recording for all waveform digitizer models. For the 6810 Waveform Digitizer, it also controls input coupling/range, active channels, trigger settings, memory segmentation/timestamps, and multiple timebase operation.

WAVEFORM-CATALYST sends instrument setup instructions and receives status information and waveform data via an IEEE-488 Standard Interface bus (GPIB) between the PC and the instrument chassis.

### FLEXIBLE, MODULAR DESIGN

The user controls up to 10 different instrument models. WAVEFORM-CATALYST can be reconfigured with different sets of instrument drivers to control other instrument types. The instrument types include LeCroy waveform digitizers, amplifiers, and gate generators.

LeCroy initially configures WAVEFORM-CATALYST with customer requested drivers. A library disk contains a loading routine and a complete selection of drivers for future modifications.



### SIMPLE OPERATION

Single keystrokes on the PC keyboard control instrument setup, signal averaging, histogramming, PASS/FAIL testing and display manipulation. Each key is directly mapped to a function - no multiple level menus! A help screen explains the function of each key. Instrument settings can be viewed and modified via a full page, spreadsheet-like, setup menu.

To quickly set up commonly used configurations, WAVEFORM-CATALYST lets the user recall an unlimited number of "front panel" settings. Each setting has its own user-defined name.

### LONG WAVEFORM RECORDS

WAVEFORM-CATALYST can transfer and display long waveform records. It can transfer up to 16 Msample records from 8818A and 8828D waveform digitizers and up to 8 Msample records from 6810 waveform digitizers directly to the PC's hard disk, without any intervention by the operator.

### SIMULTANEOUS 4 TRACE DISPLAY

WAVEFORM-CATALYST displays 1, 2, 3, or 4 waveform traces, time and volts per division for each trace, cursor readouts, time, date, and an optional user-entered comment. Traces can



represent "live" waveform data or previously stored data. Individual waveforms can be expanded and positioned to expose details or to overlay on other traces for comparison. Dual cursors read out the time from trigger to that point, time difference between cursors, absolute amplitude, and amplitude difference between cursors.

The full color display provides a separate color for each waveform to help the user identify traces. With user-keyed labeling, WAVEFORM-CATALYST lets the operator clearly identify traces, add comments to waveforms, and store/recall named waveforms. Trace labels and comments get stored with the waveform data.

LeCroy waveform digitizers can record more information than even high resolution monitors can display. Therefore WAVEFORM-CATALYST lets the user choose between two data reducing, display algorithms. The "quick draw" algorithm simply displays every Nth point in the waveform record (decimation). It updates the display quickly. The other method has a slower display update rate, but ensures the display of glitches and other transients via a proprietary "compacting" algorithm.

Paging through long data records, 8 ksamples at a time, lets the operator view details on every waveform section. A "join" feature decimates or compacts even ultra-long records for an overview of the entire waveform.

## HELPFUL TRIGGERING MODES

Different triggering modes help to simplify instrument setup and to effectively acquire waveforms of interest. AUTO trigger automatically generates a trigger every 3 seconds. SINGLE trigger arms the digitizer once and waits for an external trigger to capture a single transient event. NORMAL trigger acts like SINGLE, except it re-arms the digitizer after each trigger. MANUAL lets the user force a trigger to occur, even if the system is already in one of the other modes. FREEZE trigger inhibits incoming triggers to allow evaluation of data on the PC screen.

## SIGNAL AVERAGING, HISTOGRAMMING, AND LIMITS TESTING

WAVEFORM-CATALYST executes signal averaging in the PC if an 8901A CAMAC-to-GPIB interface is installed. If the 6010 interface is installed,

WAVEFORM-CATALYST automatically uses the 6010 to do the averaging at much higher speeds. From the user's viewpoint, operation is identical.

Histogramming plots how often the waveform is sampled at each voltage level. Waveform limits testing, also called PASS/FAIL testing compares the waveform against high and low waveform envelope limits. Two different waveforms can be PASS/FAIL tested simultaneously.

## SIGNAL PROCESSING FACILITY

WAVEFORM-CATALYST software can save waveforms to disk in two ways: recallable format or ASYST format. ASYST Scientific Software (see LeCroy model 6920-488) provides waveform arithmetic, analysis including FFTs, curve fitting, statistics, matrix math, and array editing. It operates in either an immediate mode (like a calculator) or a programmed mode. If saved in ASYST format, ASYST can directly read the waveform data as an input array, ready for any analysis.



## 6900 Specifications

### INSTRUMENTS SUPPORTED

**LeCroy Instrument Drivers:** 6880/A/B, 8828C/D, 8818/A, 6389, 8837F, 6810, 8212A, 8212A/8, 8210, 2262, 6103, 8100, 2323, 4222, 2249, 2259, 2228, 4208, 8501

**Max Number Drivers Loaded:** 10 total of any combination or duplication (for multiple channel applications)

**Max Number of Instrument Chassis:** 14 (GPIB limit)

### WAVEFORM DISPLAY

**Monitors Supported:** CGA (200 vert. X 640 hor.), EGA (350 vert. X 640 hor.), Compaq III (400 vert. X 640 hor.), VGA (480 vert. X 640 hor.)

**Number of Traces:** 1 to 4, each either live or stored data

**Waveform Display Algorithm:** Either quick draw or "compacting" glitch detection; Either sample points alone or connected with straight lines

**Waveform Update Rate:** More than once per second on an IBM AT

**Zoom Expansion:** Horizontal or vertical in 1-2-5 sequence; unlimited number of expansions.

**Cursors:** Primary cursor - absolute voltage, time from trigger point; Secondary cursor - delta voltage, delta time from primary cursor

**User Comment:** 160 characters

**Colors:** Choice from 16 colors for background, grid, traces, labels.

**Hardcopies:** Laserjet or Epson graphics printers

### INSTRUMENT CONTROL

**Settable Parameters:** Instrument dependent

**Setup Method:** Single keystroke selections of instrument parameters on spreadsheet-like menu

**Trigger Modes:** Auto, Single, Normal, Manual, Freeze

### PROGRAMMING

#### (AUTOSEQUENCE MODE)

**Learn Mode:** Learns a sequence of keystrokes as an executable program

**Edit Mode:** Allows operator to view, delete commands, and add commands and constructs to a program

**Run Mode:** Executes program

**Programming Constructs:** Loop, branch to a label, wait, assign up to 25 variables, and print variables

**Error Checking:** During recall of stored program; before running a new or edited program

**Maximum Program Size:** 400 lines

### SIGNAL AVERAGING

**Number of Active Channels:** 1, 2, or 4

**Number of Waveform Samples:** 64 to 8192, divided amongst channels being averaged

**Number of Waveforms Averaged:** User selectable from 1 to 8,388,608 for 8-bit data (default 100 waveforms)

**Averaging Type:** Summation (6010 or 8901A) or exponential (6010 only)

**Averaging Rate With 8901A:** 3 - 5 waveforms per second

**Averaging Rate With 6010:** See 6010 data sheet

**Display Update Rate:** User selectable from after each acquisition to once every 5 minutes (default 5 seconds)

### HISTOGRAMMING

**Number of Active Channels:** 1, 2, or 4

**Number of Waveform Samples:** 64 to 8192, divided amongst channels being histogrammed

**Number of Waveforms Histogrammed:** User selectable from 1 to 2,147,483,648 for 8-bit data (default 100 waveforms)

### LIMITS TESTING

**Number of Active Channels:** 1 or 2

**Action on Out-Of-Limit Condition:** Any combination of 1) store the waveform to disk, 2) print the screen, 3) print only the number of errors, time and date, and/or 4) freeze the trigger.

**Limit Envelope Sources:** Trace 1 or 3 with user-selected tolerance, or stored limits

### DATA STORAGE

**Archive Rates:** 10 kbytes/second to hard disk; 1 kbyte/second to floppy disk

**Data Types:** Waveforms, instrument setups, and Autosequence programs

**Waveform Storage Format:** User selectable as ASYST readable or WAVEFORM-CATALYST readable (unformatted data plus a descriptive header and user comments)

### REQUIRED PC CONFIGURATION

- IBM PC/AT, IBM PS/2 (except Model 25 or 30), Compaq 286/386, or strict compatibles at user's responsibility
- 640 kbytes RAM
- Math coprocessor
- 1 hard disk
- 1 floppy drive
- National Instruments GPIB-PC2 interface card
- PC DOS version 3.0 or above

### ORDERING INFORMATION

- |         |   |
|---------|---|
| 6900-5  | WAVEFORM-CATALYST PC software (5.25 inch disk format). Includes executable code, National Instruments software handler, and Halo 88 Graphics Package. |
| 6900-3  | Same as 6900-5 except on 3.5 inch disk format.  |
| 6900-5S | Same as 6900-5 except includes source code and Function Library.  |
| 6900-3S | Same as 6900-5S except on 3.5 inch disk format.   |
| 6909-3  | Microsoft Fortran version 4.1. Required for modifications to 6900-5S or 6900-3S.  |



## 6910-DEV Development Package for the 6010 Controller

### Main Features

- "C" language programming for LeCroy 6010 CAMAC controller
- High speed local data analysis and control for CAMAC instrument modules
- Access to 6010 ROM resident routines for CAMAC, GPIB, & RS-232C I/O
- Local 6010 video graphics display output

### SOFTWARE DEVELOPMENT SYSTEM FOR THE LeCROY 6010 CAMAC CONTROLLER

The LeCroy 6910-DEV Software Development System provides the necessary tools to develop custom application programs. These programs can be executed locally in the LeCroy 6010 CAMAC Controller. They enable the user to process data from CAMAC measurement instruments and make decisions locally, in the CAMAC chassis. The local processing minimizes data transfers to a host computer and thus substantially improves throughput for real time or automated test applications.



A two day training course is included with each Model 6910-DEV development system. Training courses are held at least once each quarter. Those attending the course should possess a good

working knowledge of the C programming language and a basic understanding of how to control CAMAC (IEEE-583) instrumentation.



---

# Modular Digitizer Systems

---

## TARGET ENVIRONMENT

The LeCroy Model 6010 CAMAC Controller provides simple remote control and data transfer for standard CAMAC modules, including LeCroy's Waveform Digitizers.

The Motorola MC68020, a 32-bit microprocessor running at 10 MHz is the heart of the 6010 controller. This powerful microprocessor is augmented by the MC68881, a true floating-point coprocessor running at 16 MHz.

The 6010 Controller also has a composite video output which can display local and remote graphics or text with a screen resolution of 512 x 232. A real time clock with a 1 millisecond resolution timer is provided for applications which have timing requirements.

The user has more than 400 kbytes of RAM space in the 6010 controller for application programs and data storage. In addition, 256 kbytes of functions are stored in the 6010's firmware for use with the application programs developed using the 6010-DEV.

### 6010 Supported Functions include:

- CAMAC I/O Functions
- Stream Oriented I/O Functions
- Graphics Functions

The built-in firmware routines combined with the Motorola processors make the 6010 a powerful and fast controller. The following table provides a sample of the 6010 performance:

## Typical 6010 Execution Speeds

- ~ 1.3 microseconds per 16-bit CAMAC read/write cycle
- ~ 1.7 microseconds per 8-bit GPIB write cycle
- ~ 2 microseconds per double precision floating-point compare
- ~ 5 microseconds per byte to extend 80-bit floating-point conversion
- ~ 30 microseconds per calculation of logarithm (base 10)
- ~ 30 Hz graphics display updates for 2 x 400 point waveforms

## DETAILED PRODUCT DESCRIPTION

The 6910-DEV Software Development System consists of the following items

- **Cross Code "C"** (Software Development Systems Inc.): C programming language compiler. This compiler includes many ANSI enhancements, a macro relocating assembler, a powerful linker and librarian, and a symbol listing utility. The compiler can also generate assembly language listings which are useful for program code optimizing.
- **Make Utility:** This utility automates the compiling, linking, and S-record generation process of the program development cycle.
- **MKS Programming Tool Kit (Mortice Kern Systems Inc.):** This collection of PC software routines, such as the Text Editor and other

UNIX system V tools, simplify programming within the DOS environment.

- **PC-Lint C Programming Language Error Checking Program (Gimpel Software):** This PC program finds syntax errors, bugs, and structure inconsistencies in the source code and generates a detailed error report for the programmer.
- **Host Program:** This PC program downloads the S-record generated by the 6910-DEV via the GPIB (IEEE-488) and starts program execution.
- **Other Utilities from LeCroy:** These utilities contain the 6010 PROM map files, some example programs, and an RS-232C Host program to download the S-records via RS-232C.

## HARDWARE REQUIREMENTS

To develop application programs using the 6910-DEV software development system, the following equipment is required:

- IBM AT® or 100% compatible with:
  - 640 Kbytes of system memory
  - >10 Mbyte hard disk
  - DOS 3.1 or higher
  - 1.2 M-byte 5 1/4 " floppy disk drive
  - National Instruments GPIB Interface (optional)
- LeCroy 6010 CAMAC controller with PROM Version 5.0 or later



**TYPICAL PROGRAM DEVELOPMENT CYCLE**

The six steps below depict a typical 6910-DEV application program development cycle. Prior to actual coding, the programmer must conceive the application using standard CAMAC instrumentation modules and review the F-A-N function codes and operation for those modules.

**Step 1: User Editing Session**

The programmer constructs the C source code using the Editor supplied with the package or any other ASCII text editor.

**Step 2: C Program Error Checker**

The error checking program will catch many of the bugs or structure inconsistencies in the source code before compiling the code. This program returns a detailed error report.

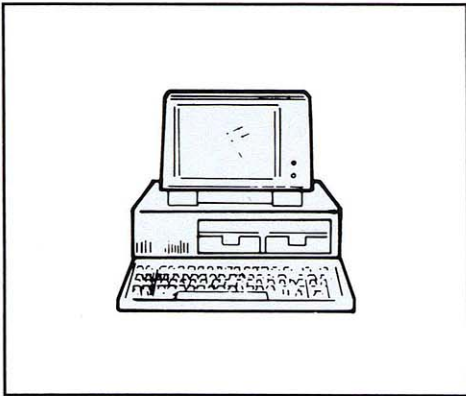

Steps 1 through 4.

**Step 3: Edit MAKE Configuration File**

The user edits the "MK. CFG" file to specify files needed to MAKE the application program.

**Step 4: MAKE Utility Program**

The MAKE utility automates the Compile-Link process and produces the S-record to be downloaded to the 6010 Controller.

**Step 5: Host Program**

The Host Program downloads the S-record via GPIB (IEEE-488) or RS-232C to the 6010 controller and starts executing the application program.

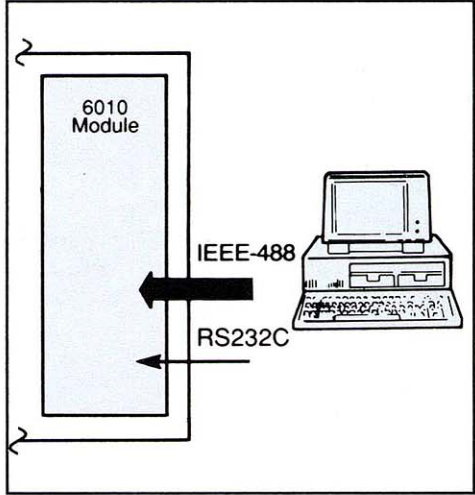

Step 5.

Because most of the executable code is in the 6010 firmware libraries, the time to re-compile, re-link and download is usually less than 5 minutes. Actual download times depend on the size of the application program, the speed of the development computer, and the extent of changes made to the source code files.

**Step 6: The custom 6010 program controls the instruments and analyzes the data.**

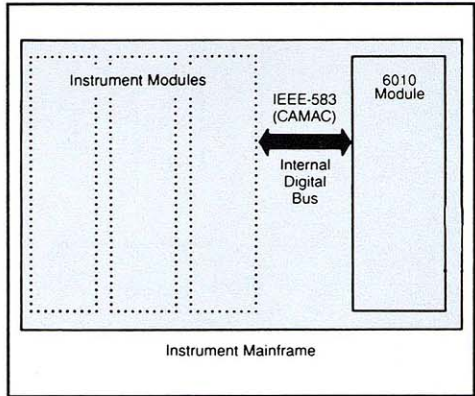

Step 6.



# Modular Digitizer Systems

Typical applications include:

- High-speed closed-loop control using CAMAC waveform digitizers and CAMAC digital-to-analog converters. The 6010 makes control decisions based upon the measurements.
- High-speed local data analysis for PASS/FAIL testing where the 6010 only transfers the result to the host computer.
- High-speed local display of calculated results directly via the 6010 external monitor output.

## EXAMPLE 1

The below figure depicts the block diagram of an automated test application. The 6010 makes PASS/FAIL decisions based upon analysis of the digitized data. The 6010 transfers two data points from the 8828 Digitizer memory to the 6010 every 1.3  $\mu$ sec ( $>1.5$  megabytes per second). In contrast, if the host analyzed the data, then slow GPIB transfers would significantly reduce overall throughput. Analysis in the 6010 eliminates GPIB transfer time, thus decreasing overall test time.

## EXAMPLE 2

This figure depicts a block diagram of a RADAR antennae control application. Received RADAR pulses are down converted and digitized. The 6010 compares two digitizer channels, representing horizontal and azimuth antennae position, against a reference signal. The 6010 uses the results to control servo motors which position the antennae.

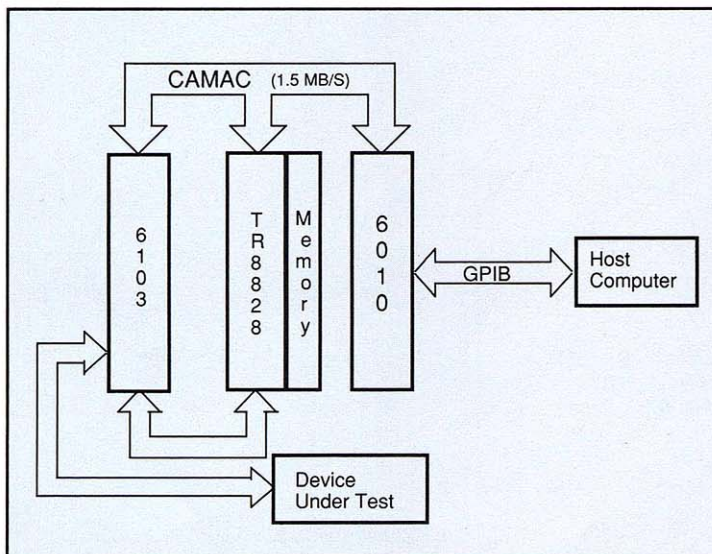

Example 1

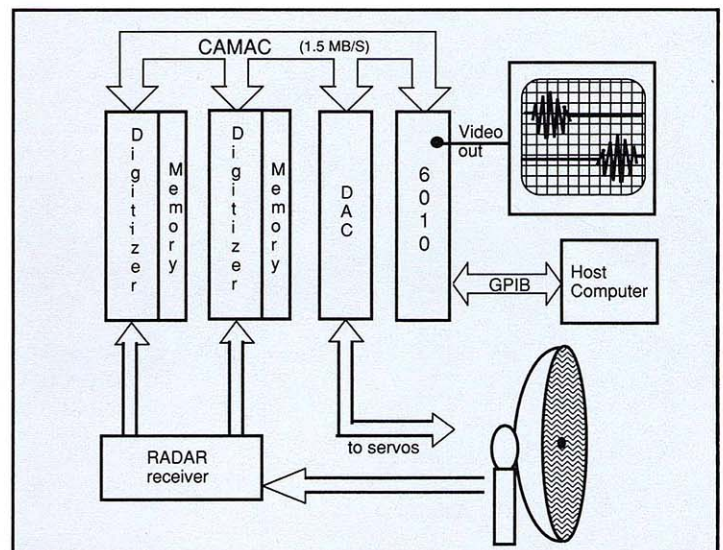

Example 2



## 6920-488 ASYST™ Scientific Software 6920-DL Digitizer Driver Library

### Main Features

- Fully integrated waveform acquisition, analysis, and graphics
- Simple control of LeCroy waveform digitizers and other GPIB instruments
- Interactive or programmed operation
- Reduced program development time

**Effortless IEEE-488 Control and Powerful Waveform Analysis:** LeCroy PC-based 6920 Series Software combines with LeCroy Waveform Digitizers to form powerful waveform analysis systems. The ASYST programming language combined with the 6920 DL Driver Library slash custom ATE and research programming time when using LeCroy waveform digitizers. Plus, the compiled ASYST programs execute much faster than programs written in most other instrument control languages.

### 6920-488 Programming Language (ASYST)

- High level structured language
- Pre-written functions
- Fast array manipulation and analysis

ASYST is a PC-based, command-driven, fully integrated, real-time data acquisition, data analysis, and graphics software package. Its command set rivals established scientific libraries.

ASYST operates in either immediate mode or programmed mode. Immediate

mode works much like a calculator. Type in a command and ASYST returns an answer. Programmed mode uses the same immediate mode commands within a user-written, fast executing program.

In either mode, ASYST's keyword commands and set-based operations make it the world's most powerful language for waveform data acquisition and analysis. The keyword structure lets you define custom functions. The set-based operation means high speed waveform manipulation and analysis.

In programmed mode, ASYST reduces program development time for design, test (ATE), and research applications. Key features contributing to this efficiency include its:

- Structured and integrated language
- Over 2,000 powerful pre-written routines
- Complete GPIB integration with LeCroy Waveform Digitizers via LeCroy 6920-DL Driver Library
- Simple GPIB commands for generic instrument control
- Useful time-saving debugging tools

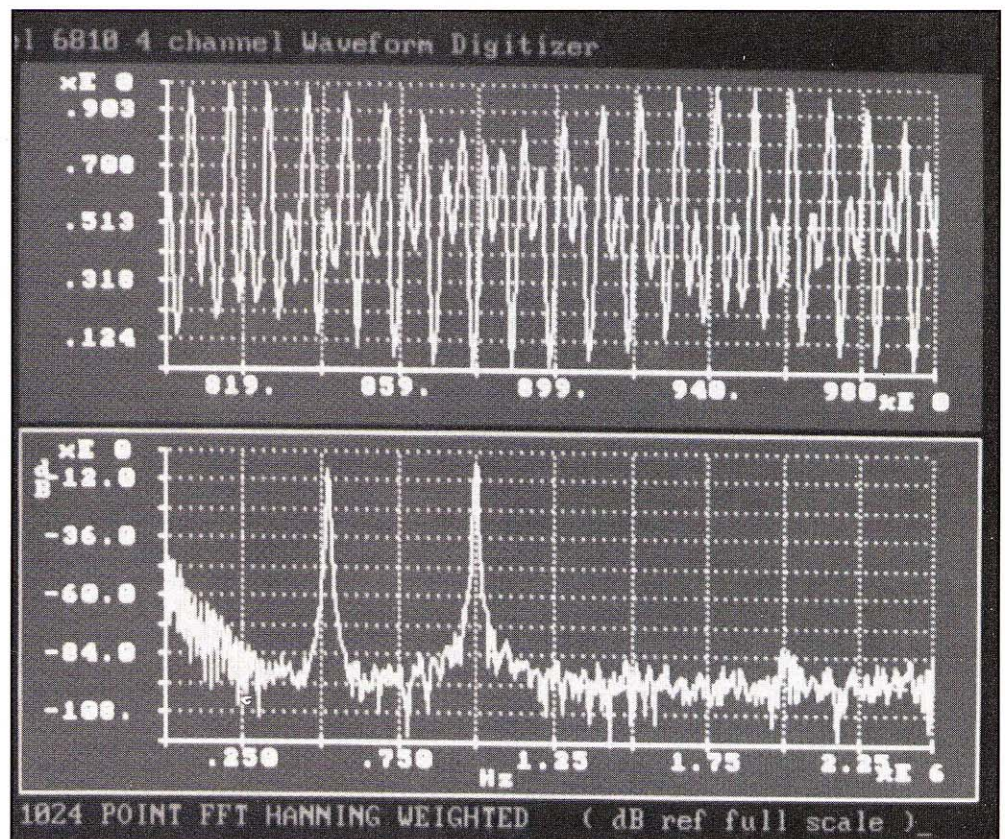



# Modular Digitizer Systems

LeCroy offers configured ASYST software as the 6920-488 package. It consists of ASYST Scientific graphics, analysis, and GPIB control software (modules 1, 2 and 4). The 6920-DL package adds a "LeCroy drivers" selection to the ASYST system configuration menu. It allows the user to integrate LeCroy Waveform Digitizer control commands into the ASYST language.

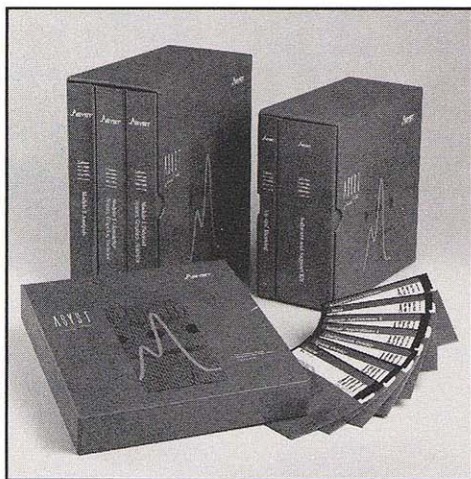

## EASY PROGRAM DEVELOPMENT

Custom program development goes quickly. The ASYST language offers a wide variety of decision and branching commands. These building blocks simplify the task of writing easily modified, structured programs.

The 6920-DL Driver Library sets a new ease-of-use standard for IEEE-488 bus (GPIB) control of waveform digitizers. These commands simplify integration of LeCroy waveform digitizers with other

GPIB based instrumentation for ATE applications. Additionally, ASYST contains a generic GPIB programming command set.

For numerical calculations, ASYST uses a memory area reserved for numbers and arrays called a "stack." Since each operation leaves its result on the stack, commands follow one another seamlessly. Unlike most other languages, ASYST passes variables and arrays to subroutines from the stack position, rather than by name. Therefore ASYST routines are completely independent and easily used in different programs.

## OVER 2000 POWERFUL ROUTINES

ASYST offers complete data analysis and statistics functions via over 2,000 pre-written routines. High level commands called "keywords" invoke these routines. A programmer would need years of research and coding time to develop these analysis and graphics routines. Each keyword equates to dozens of lines of code in any other language. They all come standard with ASYST.

The standard ASYST library of routines includes array mathematics, calculus, fast Fourier transforms, statistics, digital filtering, curve fitting, and hundreds of other functions. Memorable math keywords, such as FFT, LOCAL.MAXIMA, SMOOTH, and ESTIMATE.ROOTS, quickly return answers.

ASYST lets you define your own analysis keywords, too. You can redefine the standard ASYST keywords to more fa-

miliar names. Also, you can create new keywords to provide custom analysis functions for your application. New words can permanently become part of your ASYST environment. In a program, these self-descriptive commands require few additional comments for complete documentation.

## GRAPHICS AND HARDCOPIES

Pre-written ASYST graphics keywords save time. ASYST contains a full selection of two and three dimensional graphics functions. For all graphics displays, grid colors and background colors can be selected independently from a palette of 64 colors.

Graphics routines work on an array of data, such as a digitized waveform. For example, the command XY.AUTO.PLOT draws a graph based upon two data arrays. This single keyword instructs ASYST to:

- 1) Take the first array off the stack
- 2) Scale the X axis to the maximum value in the first array
- 3) Take the second array off the stack
- 4) Scale the Y axis to the maximum value in the second array
- 5) Draw the axes
- 6) Label the axes with tick marks
- 7) Draw a grid
- 8) Plot the nth point in each of the two arrays as an X,Y coordinate

If digitized waveform data comprised the Y array and a time-scaled ramp comprised the X array, then XY.AUTO.PLOT provides an oscilloscope-like display. Additional commands place user-defined labels on the plot.



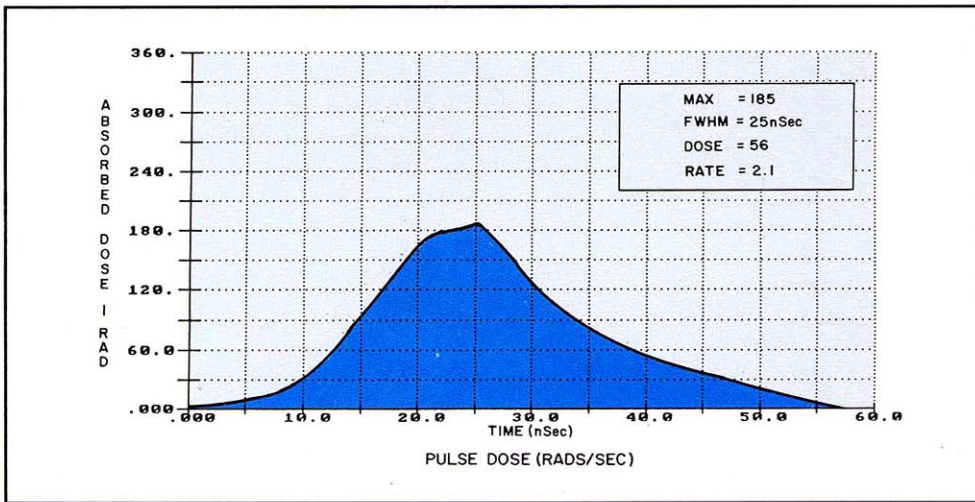

Just one ASYST command, `XY.AUTO.PLOT`, displays a captured waveform on the PC screen. One more command, `SCREEN.PRINT`, sends the data as displayed to the PC printer.

ASYST plots the data in user-defined engineering units, too! With one command, multiply the data array by the appropriate conversion factor before plotting.

ASYST simplifies report generation. Just a single command sends the screen display to your choice of common graphics printers or color plotters.

## LONG WAVEFORM MANIPULATION

MS-DOS addressing limits active user space to 64 kbytes. LeCroy digitizers can store waveforms much longer than 64 kbytes in length. ASYST offers three basic methods of manipulating these large waveform blocks:

- 1) Hard or floppy disk files
- 2) Extended memory tokens (LIM)
- 3) Main memory arrays

In all three methods, the waveform must be broken down into 64 kbyte pieces for analysis. The 6920-DL Manual appendices contain example programs for manipulating long waveforms.

Disk storage only limits waveform size by the available space on the disk. Some modern hard drives store over 100 Mbytes. The fast access times prevent long delays while storing waveforms.

For faster manipulation of long waveforms, ASYST can store waveforms to extended memory. ASYST memory tokens allow the programmer to access up to 8 Mbytes of LIM (Lotus-Intel-Microsoft memory management scheme) expansion memory. The LIM memory acts like a virtual RAM disk. Each LIM page holds one 64 kbyte section of the waveform.

For manipulation of 128 kbyte or shorter waveforms, main memory arrays provide the most cost effective solution. The ASYST transient overlay architecture lets you proportion more memory for main memory arrays. Seldom-used functions can be selectively loaded. Commonly used functions can be loaded permanently as part of your personal system.

	ASYST	FORTRAN	BASIC	APL	PASCAL	C	FORTH
Compiled?	YES	YES	YES	some	YES	YES	YES
Structured flow control?	YES	YES	some	YES	YES	YES	YES
Interactive?	YES	no	YES	YES	no	no	YES
Complete support of complex numbers?	YES	no	YES	YES	no	no	no
Integrated data manipulation/analysis?	YES	no	no	no	no	no	no
High level interactive integrated graphics?	YES	no	no	no	no	no	no
Integral array operations?	YES	no	no	YES	no	no	no
Integral support of 8087/80287/80387 chips?	YES	YES	YES	some	YES	YES	some
Integral support of expanded memory boards?	YES	no	no	some	some	some	no

Comparison based on ASYST 3.0 Microsoft FORTRAN version 401. Quick BASIC version 4.0 APL, version 7, Borland Turbo Pascal version 4.0, Microsoft C version 5.0, and FORTH 83.



---

# Modular Digitizer Systems

---

## DEBUGGING TOOLS

ASYST software contains truly useful debugging facilities. For example, an error tracer function quickly identifies programming mistakes. Since ASYST programs can execute either interpretively or compiled, a section of the overall program can be developed using interpretive execution. If an error occurs when running this section, an error tracer lists the commands leading to the error.

Once a section has been debugged and runs cleanly, it can be compiled independently as a subroutine (keyword). These compiled sections can then be called from new untested, noncompiled (interpreted), program sections. Thus, as the overall program is developed, the execution speed does not decrease due to a long interpretive program.

## FAST PROGRAM EXECUTION

Compiled ASYST program execution time compares to speedy low-level languages. Furthermore, GPIB Direct Memory Access (DMA) operation speeds waveform transfers from LeCroy waveform digitizers to the host PC. The ASYST architecture utilizes the PC math co-processor to reduce waveform analysis (e.g. FFTs) time.

## HELP

ASYST provides a HELP disk for on-line assistance to commands and their usage. Once in HELP, the user selects from topic-of-interest menus using the PC Function keys.

## ASYST SOFTWARE CAPABILITIES

### SYSTEM CHARACTERISTICS

Fully integrated data acquisition, analysis, and graphics  
Sophisticated array-based waveform processing and analysis

Flexible, interactive graphics with plotter and printer support  
Interactive on-line help and menu driven system configuration  
Error tracer shows command sequence leading to user program bugs  
Supports LIM expanded memory boards for storing large numbers of waveforms for quick access  
Variable length command-history function with edit (in immediate mode only)  
Program access to real-time clock

### DATA TYPES

Single or double precision integer (16 or 32 bits), real (32 or 64 bits), or complex values (64 or 128 bits)  
Strings  
Scalars  
Arrays up to 16 dimensions

### PROGRAM CONTROL

If..then  
If..else..then  
Case..endcase  
Do..loop  
Begin..until  
Begin..while..repeat  
Begin..again  
Number or array comparison =,>,<,>=,<=,<>  
True/false, NOT, AND, OR, XOR

### PROGRAM INTERRUPTS

Real time clock

### INPUT/OUTPUT

File conversions to and from DIF, ASCII, BASIC, packed binary, and Lotus 1-2-3 files  
Load from standard text files  
Save or load arrays directly to/from disk  
IEEE-488 bus and RS-232C line external I/O

### ARRAY ACCESS AND MANIPULATION

Individual elements or subarrays  
Cross-sections  
Reversal of indices  
Transposition of dimensions  
Catenation  
Lamination

### STACK MANIPULATION

For integer, real, and complex types of scalars and/or arrays: dup, drop, swap, over, rot, unrot, pick, roll, unroll, clear

### ARRAY EDITING

By row, column, cell, or entire array  
Scrolling for arrays larger than the display  
Immediate mode (cursor) or programmed cell editing  
Format control of displayed array data  
2-D array data entry by row or column

### IEEE-488 BUS (GPIB) CONTROL

English naming of GPIB device (primary address)  
Secondary addressing  
Initialize and clear  
Remote or local control  
Write/read  
Talker/listener  
End of transmission delimiters  
Timeout  
Group execute trigger  
Serial or parallel poll of service requests  
DMA data input and output  
Asynchronous, interrupt-driven operation with command queues  
Bus status display

### GRAPHICS

#### GRAPHICS FUNCTIONS

X-Y plots with indices  
Polar plots  
Contour plots  
Axonometric plots  
Pie and bar charts  
Error bars  
Labels  
Graphics scroller

#### SYSTEM FUNCTIONS

User-defined graphics windows and vuports  
Automatic scaling and fitting of data  
Linear or logarithmic display on either axis  
Superposition of multiple plots  
Plot symbol selection  
Most functions work on either display, plotter, or printer  
Text and EGA graphics modes  
16 simultaneous colors from a 64 color palette

#### DISPLAY CURSORS

Controlled by arrow keys  
Zoom-in on a section of a plot  
Specifies label locations anywhere within the graphics area  
Selects and stores coordinates within an array



## ANALYSIS

### ARITHMETIC

For integer, real, and complex types of scalars and/or arrays: +, -, x, /, \*\*, min, max, neg, abs, inv, sqrt, ln, exp, conj, sin, cos, tan, sec, csc, cot, sinh, cosh, tanh, sech, csch, coth, asin, acos, atan, asec, acsc, acot, asinh, acosh, atanh, asech, asch, acoth

### WAVEFORM ANALYSIS

Fast Fourier transform (FFT)

Inverse FFT

2-dimensional FFT

Smoothing

Convolution and filtering

Peak detection

Integration

Differentiation

### CURVE FITTING

Weighted and non-weighted fits

User-defined and non-linear fits

Multilinear, logarithmic, polynomial, and exponential fits via

least-square regression

Cross correlation

Correlation matrices

Goodness of fit reporting

### MATRIX MATH

Polynomial evaluation

Polynomial addition and subtraction

Polynomial multiplication and synthetic division

Polynomial integration and differentiation

Polynomial shifting

Root extraction

Simultaneous equations, matrix inversion, and determinants

Inner products

Matrix multiplication, adjoint, and trace

Diagonalization

Orthogonalization

QR factorization

Eigensystems of Hermitian matrices

Spectral slicing

Reduction of a general matrix to Hessenberg and triangular form

### STATISTICS

Mean, Median

Variance

Mode

### Moments

Standard deviation

Cumulative distributions

Gaussian distributions

Chi-square distributions

Student-T distributions

F-tests

Random number generation

Sort; sort and index

1- and 2-way ANOVAs

## REQUIREMENTS

- IBM PC/XT/AT, PS/2, Compaq 386 or III, or 100% compatible
- DOS version 2.0 to 3.2
- Math co-processor (8087/80287/80387)
- 640k bytes of memory (RAM)
- CGA or EGA graphics board
- IEEE-488 interface card: Any one of National Instruments GPIB-PC, GPIB-PC2, GPIB-PC2A, Capital

Equipment PC-488 Models 300 and 310 MetraByte IEEE-488, IBM GPIB, HP 61062AA HPIB, or IOtech GP488

## OPTIONS

- Printer: IBM Graphics, Epson Graphics, HP LaserJet, HP InkJet, HP ThinkJet, Okidata ML182, TI 855/865, or IBM Proprinter.
- Plotter: HP 7470, HP 7475, Gould Colorwriter #2
- Dataq Waveform Scroller board
- LIM (Lotus-Intel-Microsoft standard) expanded memory board

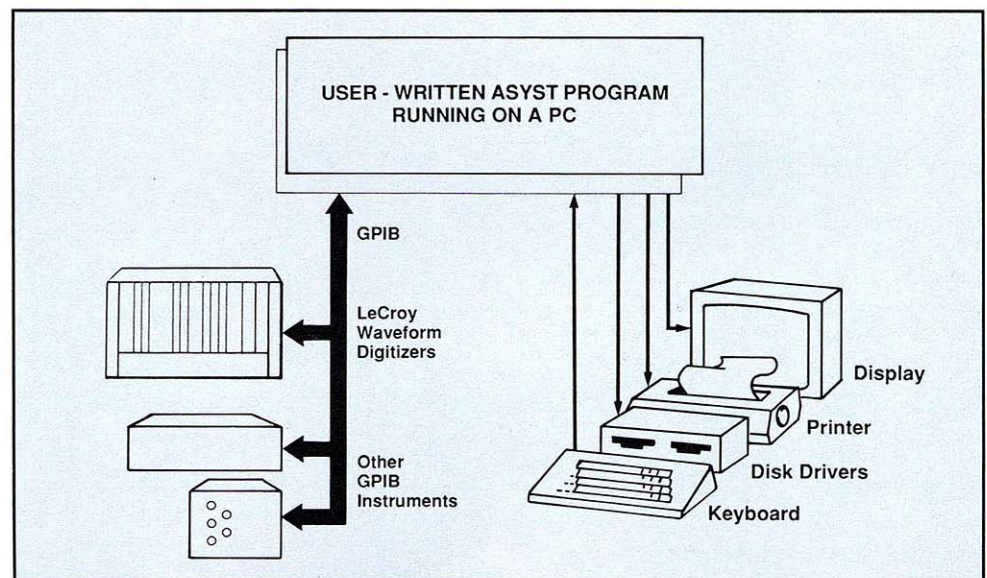

ASYST ties LeCroy waveform digitizers and other vendors instruments into ATE systems. The PC keyboard functions as a test operator input panel. Results can be displayed, hard copied, or stored to disk.



# Modular Digitizer Systems

## 6920-DL Digitizer Driver Library

- Fast system startup with LeCroy Waveform Digitizers
- High accuracy FFT analysis

The 6920-DL package lets you control LeCroy waveform digitizers from ASYST software. It requires 6920-488 software to operate. The 6920-DL supports:

- 6880A/B Waveform Digitizers,
- 8828C/D Waveform Digitizers,
- 8818A Waveform Digitizers,
- 8837F Waveform Digitizers,
- 6810 Waveform Digitizers,
- 4222 Gate/Delay Generator
- 8212 Waveform Digitizer
- 6103 Programmable Amplifiers, and
- 6010 and 8901A GPIB to CAMAC Interfaces.

The 6920-DL Driver Library includes a library disk and manual. The manual includes programming examples for each command and entire ASYST programs for common operations.

The 6920-DL Driver Library provides ASYST keywords for digitizer setup and waveform data transfer operations. All LeCroy Waveform Digitizers are fully programmable across the IEEE-488 Standard interface bus (GPIB). The 6920-DL software controls all operating parameters of the supported instruments.

The 6920-DL keywords let you work with blocks of waveform data, not with bytes and GPIB talk/listen commands. The 6920-DL eliminates bus level commands. Each high-level English-like command handles both the bus communication and the actual instrument

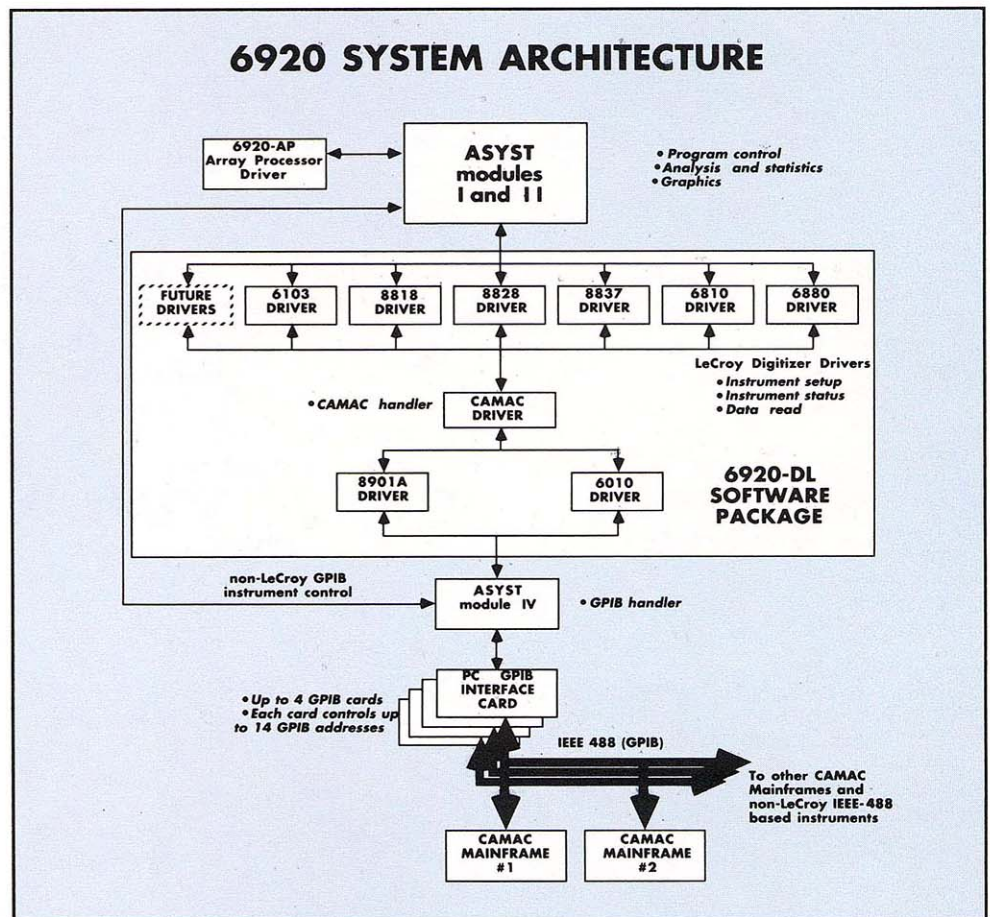

control. This high degree of integration allows even novice programmers to quickly develop test programs.

The mnemonic commands can be remembered, rather than referenced, which further cuts development time. And if a particular command name is difficult for the programmer to remember, he can rename it.

The 6920-DL Library uses consistent commands. This consistency simplifies simultaneous programming of several different LeCroy Waveform Digitizers. For example, the same style commands "arm" a digitizer:

- 6810.ARM**
- 6880.ARM**
- 8828.ARM**
- 8818.ARM**
- 8837.ARM**



Similarly, the same style commands read waveforms from a digitizer:

```
6810.READ.DATA
6880.READ.DATA
8828.READ.DATA
8818.READ.DATA
8837.READ.DATA
```

The XXXX.READ.DATA commands set up the digitizer for readout, transfer the data across the GPIB into PC memory, store the block as integer data, unpack it, and place it on the stack ready for analysis. Other keywords even handle instrument requests for attention, poll the instrument, and return status.

## VERY ACCURATE SPECTRUM ANALYSIS

The low noise, long waveform memory LeCroy digitizers, the 80-bit PC co-processor precision, and the ASYST FFT algorithm together provide high accuracy fourier transforms. The long waveform records produce very fine frequency bin resolution. The fine bin resolution allows use of a "Flat Top" FFT window for accurate spectral peaks.

## SAMPLE PROGRAM

```
OK 1 8901 CAMAC          \Define crate address / type
OK INIT. CAMAC          \Initialize CAMAC
OK 5 CAMAC. SLOT        \8828 is in slot 5
OK DIM[ 1024 ] DMA. ARRAY DATA \Save space for a DMA array "DATA"
OK 8828,DEFAULT.SETUP   \Set 8828 to 200MS/sec, 0 offset,
                        16k memory, no pretrigger
OK 8828.ARM             \Arm the 8828 digitizer
OK TRIG.WAIT           \Wait for trigger
OK 8828 ENABLE.READ     \Enable the read mode
OK DATA 8828.READ.DATA \Read the waveform data across the GPIB
OK HANNING.WINDOW*     \Apply Hanning window to data
OK FFT                 \Fast Fourier Transform the data
OK ZMAG                \Return the magnitude only (no phase)
OK SUB[ 1, 512]        \Discard the negative frequency half
OK. Y.AUTO.PLOT        \Plot the analyzed data to the CRT
```

Combining LeCroy digitizers and ASYST software produces up to 8192 point FFTs.

## SAMPLE PROGRAMMING

LeCroy has simplified waveform digitizer control when operating from ASYST. Now you can focus attention on analyzing test data, not on acquiring it.

In short, programming in ASYST with the 6920-DL drivers is faster, easier, and cleaner. Compared to programming in BASIC or Fortran, the ASYST 6920-DL package eliminates user-written digitizer control, display, analysis, and printout/plotter routines.

For example, the following program sets up an 8828 digitizer, "arms" it, lets it capture the waveform, transfers the data at high speed directly into PC memory, converts the data into the frequency domain via the fast Fourier transform (FFT), and displays the waveform spectrum in full color. The hardware/software integration makes the program self-documenting and keeps it short.

The 6920-DL transparently handles all the low-level bus commands to control your LeCroy Waveform Digitizers. It eliminates the need for detailed IEEE-488 and IEEE-583 (CAMAC) bus knowledge.

Compare the single XXXX.ARM command, where XXXX is the digitizer type, with the numerous ASYST GPIB commands you need in its place:

```
UNTALK
UNLISTEN
ME TALKER
CAMAC LISTENER
9 STACK.TALK
0 STACK.TALK
N STACK.TALK
CAMAC TALKER
UNTALK
UNLISTEN
```

XXXX.ARM

"N" in the N STACK.TALK command is the main-frame slot number which the digitizer is installed in. The 9,0,N represents the Function, Address, and slot Number (F,A,N) CAMAC bus command to the digitizer. CAMAC TALKER cycles the CAMAC bus so that the digitizer accepts the F,A,N command. Clearly, XXXX.ARM is simpler!



---

# Modular Digitizer Systems

---

The 6920-DL command set for the high resolution Model 6810 Waveform Digitizer is listed below. Note the descriptive nature of the 6920-DL Library keeps the advanced waveform acquisition features of the 6810 Digitizer easy to understand. Command sets for other digitizer models are even simpler.

## 6810 WAVEFORM DIGITIZER COMMANDS

6810.ABORT	6810.TBASE.F1
6810.ACTIVE.CHANNELS	6810.TBASE.F1?
6810.ACTIVE.CHANNELS?	6810.TBASE.F2
6810.ARM	6810.TBASE.F2?
6810.CLEAR.LAM	6810.TBASE.MODE
6810.DEFAULT.SETUP	6810.TBASE.MODE?
6810.DISABLE.LAM	6810.TRIG.COUPLING
6810.DISABLE.READ	6810.TRIG.COUPLING?
6810.ENABLE.LAM	6810.TRIG.DELAY
6810.ENABLE.READ	6810.TRIG.DELAY?
6810.LAM?	6810.TRIGGER
6810.MEM.SIZE	6810.TRIG.HOLDOFF
6810.MEM.SIZE?	6810.TRIG.HOLDOFF?
6810.OFFSET	6810.TRIG.LOWER.LEVEL
6810.OFFSET?	6810.TRIG.LOWER.LEVEL?
6810.POSTTRIGNEAR.SIZE	6810.TRIG.SLOPE
6810.POSTTRIGNEAR.SIZE?	6810.TRIG.SLOPE?
6810.RANGE	6810.TRIG.SOURCE
6810.RANGE?	6810.TRIG.SOURCE?
6810.READ.DATA	6810.TRIG.UPPER.LEVEL
6810.READ.SETUP	6810.TRIG.UPPER.LEVEL?
6810.READ.TSTAMP	6810.TSTAMP.RES
6810.RESET	6810.TSTAMP.RES?
6810.SEG.SIZE	6810.VERIFY.SETUP
6810.SEG.SIZE?	6810.#.SEGMENTS
6810.SOURCE&COUPLING	6810.#.SEGMENTS?
6810.SOURCE&COUPLING?	

## ORDERING INFORMATION

**6920-488** Includes ASYST Scientific Software (Modules 1,2, and 4) diskettes, manuals and copy protection block.

**6920-DL** Includes Driver Library for controlling LeCroy modular waveform digitizers with ASYST. Requires Model 6920-488.



## 1434A Rackmount Mainframe 8013A Benchtop Mainframe

### Main Features

- 400/650 W Power Output
- Tight AC Line Regulation
- Houses IEEE-583 (CAMAC) Instrument Modules
- Thermal, Short Circuit and Over-Voltage Protection
- Current and Voltage Readout (1434A)

### Instrument Housings for CAMAC Plug-ins

LeCroy Models 8013A and 1434A Instrument Mainframes provide housing for LeCroy's plug-in instrument modules. The 8013A benchtop mainframes accept instruments in combinations of up to 13 single-width plug-ins. The 1434A rackmount mainframe can accommodate up to 25 instrument modules. Hundreds of different instrumentation packages can be configured for custom applications by using LeCroy waveform digitizers, memories, amplifiers, attenuators, ADC's, time interval meters, counters, trigger generators, and even fiber optic links.

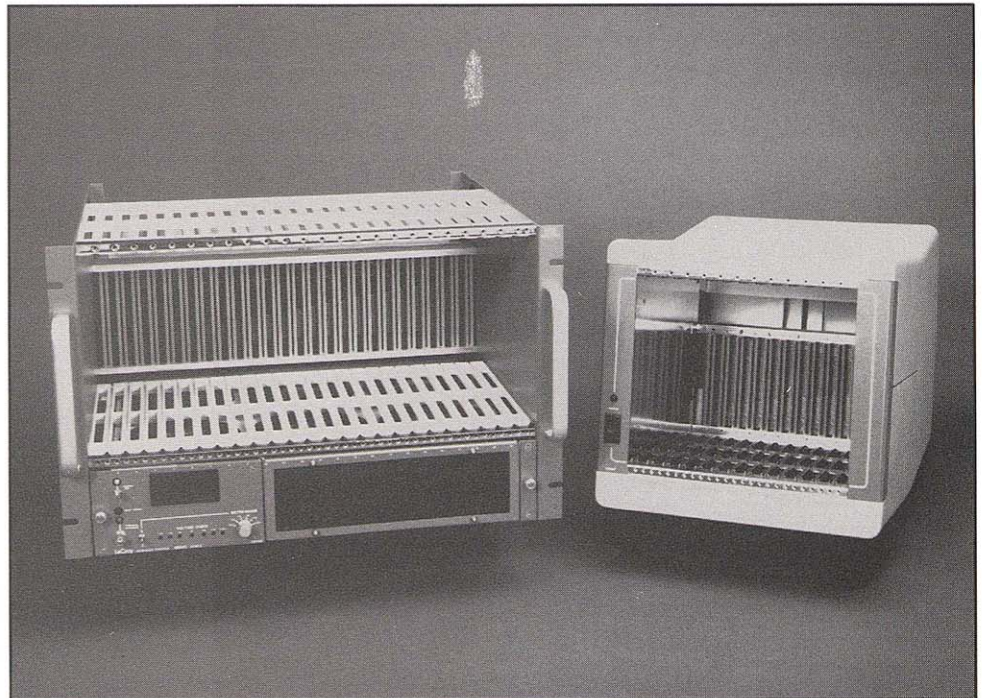

### Functional Description

Versatility, user customization, and expandability are the prime advantages of LeCroy mainframes. Many more functions than could be practically or economically combined in a single instrument are available by selecting the appropriate LeCroy instrument and accessory modules. This plug-in modular design permits the user to meet changing needs.

Both instrument mainframes offer the standard  $\pm 6$  V and  $\pm 24$  V supplies for LeCroy and other standard CAMAC modules. The high power Model 1434A, with 650W of continuous power, has  $\pm 6$  V outputs to supply a total of 90 A, with either the +6 V or -6 V supplies capable of 60 A via internal selection. In addition, the Model 1434A provides up to 6 A each on the +24 V and -24 V supplies and up to 3 A each for both +12 V and -12 V. A built-in digital multimeter on the front panel of the 1434A provides convenient monitoring of all voltage and current outputs.



---

# Modular Digitizer Systems

---

LeCroy instrument mainframes operate from standard 50/60 Hz, 110/220 V AC power. Instrument quality line regulation, long term stability, and load regulation assure reliable trouble-free operation of inserted modules. Models 8013A and 1434A are current limited and have overload protection for short circuits. Automatic overtemperature sensing shuts down the 1434A supply in the event of a thermal overload and indicates a fault. The Model 8013A has the additional feature of a short term (16 msec) uninterruptible power supply to guard against brief power line interruptions.

These instrument mainframes have been designed for user convenience and serviceability. Low insertion force connectors and quality guides are used to ensure proper mechanical alignment and ease of module installation. The Model 1434A offers a servicing feature of in-rack accessibility to the power supply and fan assembly. The two instrument mainframes provide good air flow and ventilation through forced cooling by high capacity fans.

Both Models 8013A and 1434A Instrument Mainframes meet all requirements of the CAMAC Standard (IEEE-583), assuring unrestricted choice of modules from LeCroy or second-source CAMAC suppliers.

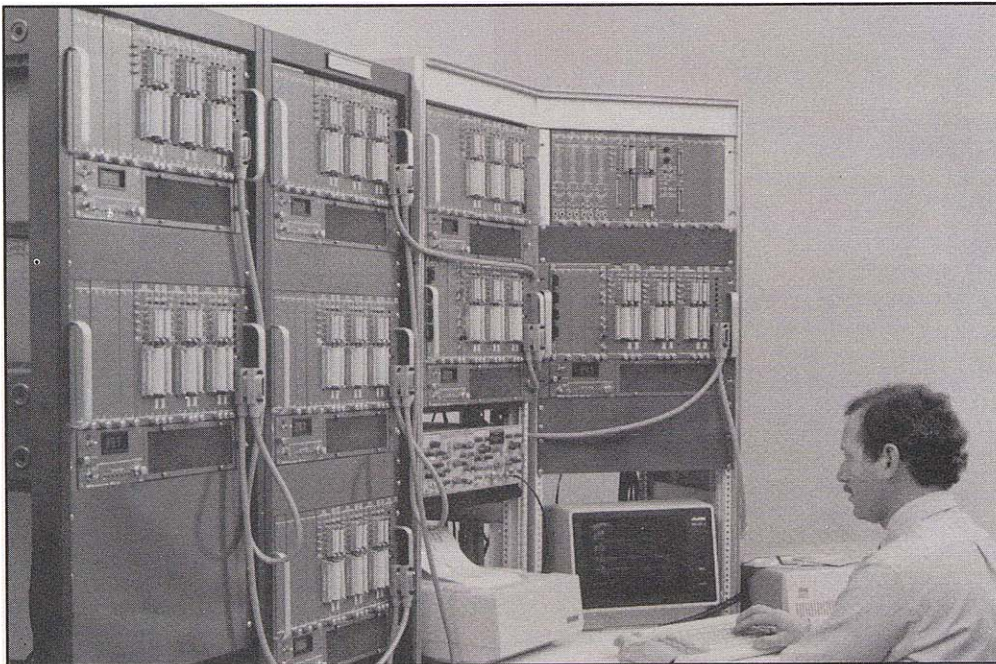

*LeCroy recorders in high power CAMAC mainframe linked by GPIB IEEE-488 Bus*



## 1434A & 8013A Specifications

### 1434A

**Module Capacity:** 23 single-width plus one dual-width controller.

**Dimensions:** 19" rackmount, 12 1/4" height, 22 1/2" depth.

**Voltage Meter:** 3 1/2 digit meter provides monitoring of all output currents and voltages. Accuracy  $\pm 1\%$  of full scale voltage;  $\pm 2\%$  of full scale current.

**Cooling:** Six high capacity fans.

**Weight:** 47 lb. (21.5 kg)

#### POWER AVAILABLE

(Conditions: Line voltage 110 V, transformer wired for 110 V, ambient temperature 25° C.)

**Total Power:** 650 W maximum  $\pm 6$  V,  $\pm 12$  V,  $\pm 24$  V combined.

#### Maximum output currents from:

**$\pm 6$  V:** Up to 60 A from either supply. 90 A maximum combined sum. Factory set to 45 A maximum from +6 V, 60 A maximum from -6 V. Reversible by user. See Graph 1 for load conditions.

**$\pm 24$  V:** 6 A maximum each. Subtract current drawn by  $\pm 12$  V load.

**$\pm 12$  V:** 3 A maximum each. Derived from  $\pm 24$  V supply.

#### PERFORMANCE

**Ripple:**  $< 2$  mV RMS (10 kHz bandwidth),  $< 5$  mV peak-to-peak (50 MHz bandwidth).

**Regulation:**  $\pm 0.01\%$  line or load (measured at the sense leads).

**Temperature Coefficient:**  $< 0.01\%/^{\circ}\text{C}$ .

**Long Term Stability:**  $< 0.1\%/24$  hours at constant load and temperature. Measured after 1-hour warmup.

**Response Time:** Settles to within 1% of final value in less than 100  $\mu\text{sec}$  for 10% to 100% load change.

**Tracking:** During turn-on all six output voltages rise together. Risetime 10 msec.

#### GENERAL

**Overload Protection:** All outputs are protected against overload by current limit circuit. Short circuit proof. All outputs switch off within 20 msec of detected overload.

**Overvoltage Protection:** All outputs are protected against transient overvoltages by high current transient suppressors. Any sustained overvoltage  $> 1.5$  V will turn off all outputs within 20 msec.

**Thermal Protection:** A thermal sensor shuts down the supply in the event of a thermal

overload. A front-panel thermal overload light on the fan tray indicates an over-temperature condition in the power supply. Remote indication of an overload is provided via an open collector TTL signal on a front-panel mounted BNC connector.

**Automatic Power Reset:** A jumper option in the fan tray activates a relay which automatically turns the supply back on when power is restored after an AC power failure related shutdown.

**Operating Range:** Full 650 W output from 0° C to 40° C ambient temperature. Derate at  $-10$  W/ $^{\circ}\text{C}$  above 40° C. Maximum ambient temperature 50° C. See graph 2.

**Line Voltage:** Field Selectable: 100/110/120/200/220/240 V AC  $\pm 10\%$ , 47 to 65 Hz.

Factory set to 110 V. 220 V operation recommended if full output power is permanently needed.

**Line Current:** 18 A rms at 110 V and full output power, 9 A rms at 220 V.

**Weight:** 53 lb. (24.1 kg).

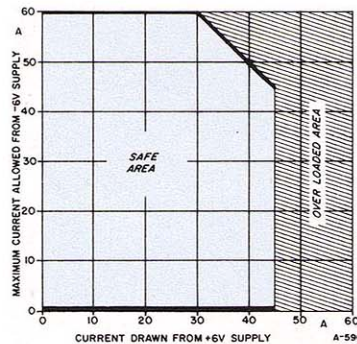

Graph 1

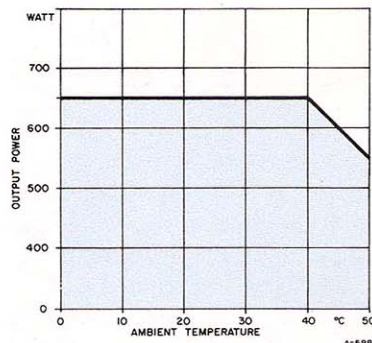

Graph 2

### 8013A

**Module Capacity:** 11 single-width plus one dual-width controller.

**Dimensions:** 14" high X 11.5" wide x 18.7" deep.

**Cooling:** Two fans provide bottom to top positive airflow. Unit should be operated on a flat surface to prevent blockage of air inlets for fans (bottom).

#### POWER AVAILABLE

+ 6 V	- 6 V	+12 V	-12 V	+ 24 V	- 24 V
23 A	23 A	-	-	2.5 A	2.5 A

**Total Power:** 400 W max,  $\pm 6$ ,  $\pm 24$  V combined, all supplies independent.

#### PERFORMANCE

**Ripple:**  $< 50$  mV p-p (50 MHz bandwidth)

**Line Regulation:**  $\pm 0.5\%$  for line changes within operating limits

**Load Regulation:**  $\pm 0.5\%$  for no load to full load changes ( $\pm 24$  V)  $< \pm 2\%$  for no load to full load changes ( $\pm 6$  V)

**Temperature Coefficient:**  $< 0.01\%/^{\circ}\text{C}$ .

**Long Term Stability:**  $< 0.1\%/8$  hour constant load and temperature after 1 hour.

**Response Time:** Settles to within 1% of final value in less than 500 msec for 50%-100% load change

#### GENERAL

**Overload Protection:** Current limit circuit; short circuit proof. Outputs switch off within 20 msec of overload.

**Energy Storage Time:** 16 msec holdup after AC power loss.

**Conducted and radiated RFI:** Filtered in power line.

**Operating Range:** 15° C to 35° C operating; -10° C to 50° C storage

**Input Voltage Requirements:** 85 to 135 VAC; 170 to 270 VAC, 47-65 Hz

**Weight:** 40 lb. (18 kg).

#### ORDERING INFORMATION

Model No.	Description
1434A	25-bay Rackmount Mainframe
8013A	13-bay Benchtop Mainframe



### 8025 Rackmount Mainframe

---

#### Main Features

- Houses IEEE -583 Standard (CAMAC) Instrument Modules
- 1000 Watts Power Output
- High, 70% Minimum Efficiency
- Tight Line and Load Regulation
- Wide 90-129 VAC and 180-258 VAC Line Input Range
- Thermal, Over-current, Over-voltage, and Fan Stall Protection
- Complete Self-diagnostics
- Current and Voltage Readout
- Designed to Meet UL 1244 and IEC 348 Safety Standards, FCC Part 15 and VDE 0871 Conducted and Radiated Emissions Level "A"



The LeCroy Model 8025 mainframe houses up to 25 instrument and interface modules. 1000 Watts of clean, regulated power support all LeCroy waveform digitizer, amplifier, attenuator, clock generator, counter, memory, fiber optic, and GPIB interface IEEE-583 Standard modules.

The 8025 high-power instrument mainframe complements the 8013A benchtop and the 1434A rackmount mainframes. The 8013A provides 13 instrument module bays. The 1434A provides 25 bays with a maximum of 650 Watts of output power.



## Product Description

The LeCroy 8025 Instrument Mainframe powers up to twenty-three IEEE-583 Standard (CAMAC) instrument modules and one GPIB to CAMAC interface module. LeCroy and other instrument companies manufacture many different CAMAC instrument modules.

### POWER OUTPUT

The 8025 mainframe efficiently delivers up to 1000 Watts of clean regulated power to installed modules. The highly efficient (70%) power supply minimizes line current (16.5 amps typical on 115 VAC mains at full power). A soft circuit limits inrush current to 40 Amperes maximum. The 8025 operates over wide ambient temperature and line voltage ranges.

The 8025 produces up to 60 Amperes on both the +6 V and -6 V outputs. It also produces up to 7 Amperes maximum on the sum of the +12 V and +24 V outputs, and 7 Amperes maximum on the sum of the -12 V and -24 V outputs. Outstanding line regulation, load regulation, and long term stability assure trouble-free operation. The 8025 provides smooth output during short power dropouts lasting up to 16 milliseconds, even at full load current.

Line voltage conversion is simple. An internal jumper change converts from 90-129 VAC operation to 180-258 VAC operation.

DC fans minimize acoustic noise and efficiently cool installed instruments and the supply. One fan cools the power supply and five others pull air past installed instrument and interface CAMAC modules.

### FAULT DIAGNOSIS AND SELF PROTECTION

The 8025 contains a complete set of over temperature, over-current, and over-voltage detection and shutdown "watchdog" circuits. These "watchdogs" ensure accurate measurements from installed modules and prevent damage to the 8025 power supply. The watchdog circuits monitor for internal failures and for improper operating conditions such as excessive current flow from a short on an installed CAMAC module, low AC line voltage, insufficient power supply ventilation, or a jammed power supply cooling fan.

To accomplish shutdown, circuits monitor for low output voltage on each of the six supplies, low or absent AC line voltage, high temperature on the power supply main heat sink, power supply fan stalling, and even for failure of the watchdog power supply itself. If a faulty condition is detected, then the 8025 shuts down all power supply DC outputs and lights an LED status indicator.

### STATUS INDICATORS

Front-panel status indicators provide a complete picture of the 8025 operating conditions. A 3 1/2 digit multimeter

displays the voltage or current being delivered from each supply (+6 V, -6 V, +12 V, -12 V, +24 V, -24 V). Push-button switches allow the user to scroll through the twelve voltage and current parameters. A corresponding LED lights to indicate the selected parameter.

If a fault generates a shutdown, the 8025 lights an appropriate fault indication LED. It remains lit until the power switch is turned off for at least two seconds. An independent supply powers the monitoring and indicator circuitry, so the watchdog functions continue to operate even during a self-protection shutdown.

### CONTROLS

The back panel ON/OFF switch applies AC power to the mainframe power supplies. In turn, if no fault conditions exist, power is then applied to the loads. When toggled to the ON position, the mainframe can be turned on remotely simply by applying AC power to it.

The DC outputs to CAMAC loads can be turned off to achieve a shutdown condition via a front-panel "Load Off" button. AC power will still be applied to the mainframe, but the power supply outputs will be shut off. The "Load Off" button is convenient for removing or installing modules or other quick supply disconnect applications. The "Load On" button can restart the mainframe after either a user-initiated shutdown ("Load-Off" button) or a fault initiated shutdown. The mainframe will re-start only when the fault condition disappears.



# Modular Digitizer Systems

## 8025 Specifications

### MECHANICAL

**CAMAC Module Capacity:** 25 slots

**Dimensions:** 15.6 inches high, 21.7 inch depth, 19 inch (rack mount) width

**Weight:** 72 lbs (approximate)

### ENVIRONMENTAL

**Ambient Operating Temperature:** 0 to +50 degrees C at 850 W output, 0 to +40 degrees C at 1000 W output

**Storage Temperature:** -10 to +85 degrees C

### POWER AVAILABLE

#### DC Outputs

+6.0 V up to 60.0 Amps (360 W)  
 -6.0 V up to 60.0 Amps (360 W)  
 +12.0 V up to 7.0 Amps (84 W)  
 -12.0 V up to 7.0 Amps (84 W)  
 +24.0 V up to 7.0 Amps (168 W)  
 -24.0 V up to 7.0 Amps (168 W)

The combined +24 V and +12 V cannot exceed 7.0 Amps. The combined -24 V and -12 V cannot exceed 7.0 Amps.

**Voltage Adjustability:** (independent for each supply)  $\pm 2.0\%$  typical via screwdriver access at rear.

### REGULATION AND STABILITY

**Regulation Line and Load:** For no load to full load, and for full range of input line voltage:

$\pm 6.0$  V:  $\pm 0.5\%$  max, within 24 hour test period  
 $\pm 12.0$  V:  $\pm 0.5\%$  max, within 24 hour test period  
 $\pm 24.0$  V:  $\pm 0.2\%$  max, within 24 hour test period

**Temperature Coefficient:** +0.2% / degree C maximum over 0 to +50 degree C

**Hold-up Time:** 16 msec minimum at 115 VAC rms or 230 VAC rms line voltage. All outputs

will remain in regulation after the loss of AC power for the hold-up time. Hold-up time is measured under full output load. Hold-up time decreases for lower AC line voltage.

**Long Term:** After 24 hour warm-up under constant line load and ambient temperature, and for a 6 month duration:

$\pm 6.0$  V:  $\pm 0.5\%$  maximum drift  
 $\pm 12.0$  V:  $\pm 0.5\%$  maximum drift  
 $\pm 24.0$  V:  $\pm 0.3\%$  maximum drift

**Remote Sensing:** All outputs are remotely sensed at the IEEE-583 backplane. Remote sensing compensates for up to .5 V total voltage drop from supply to connection points of the remote sense leads to loads. The voltage accuracy specifications are measured at the points where the remote sense leads attach to the loads (slot 13).

### TRANSIENT BEHAVIOR

#### For Any Change in Line Voltage:

Recover to 0.2% within 1 msec for  $\pm 12$  V,  $\pm 24$  V supplies  
 Recover up to  $\pm 1\%$  within 1 msec for  $\pm 6$  V supplies  
 Peak output deviation  $\leq \pm 5\%$

#### For 50% Change in Load Current:

Recover to 0.2% within 1 msec for  $\pm 12$  V,  $\pm 24$  V supplies  
 Recover to  $\pm 1\%$  within 1 msec for  $\pm 6$  V supplies  
 Peak output deviation  $\leq \pm 5\%$

#### For AC Line Turn-on:

DC voltage stable to  $\leq \pm 5\%$  within 1 sec  
 DC voltage stable to  $\leq \pm 1.0\%$  within 60 secs  
 No DC voltage overshoot during turn-on or turn-off

#### Turn-on Tracking:

$\pm 12$  V outputs track within 10%  
 $\pm 24$  V outputs track within 10%

### Output Dependency of Noise, AC Voltage, and Current

Total Output Power	850 W*	1000 W*
OUTPUT RIPPLE AND NOISE ON THE $\pm 6.0$ V SUPPLY:  DC to 130 Hz 130 Hz to 50 MHz (Iout < 4 A) (4 A < Iout < 60 A)	20 mV pp max  250 mV pp max** 100 mV pp max	25 mV pp max  250 mV pp max** 120 mV pp max
OUTPUT RIPPLE AND NOISE ON THE $\pm 24$ AND $\pm 12$ V SUPPLIES:  DC TO 50 MHz	15 mV pp max	15 mV pp max
INPUT AC VOLTAGE: Single Phase *** Low V range High V range Frequency	90 - 129 VAC 180 - 258 VAC 47 - 63 Hz	105 - 129 VAC 210 - 258 VAC 47 - 63 Hz
INPUT AC CURRENT:  Line at 100 VAC rms Line at 105 VAC rms Line at 90 VAC rms Line at 220 VAC rms  Line at 210 VAC rms Line at 180 VAC rms	14.5 A rms max 15 A rms max 19 A rms max 7.5 A rms max  8.0 A rms max 10.0 A rms max	17.5 A rms max 19.0 A rms max 9.0 A rms max  10.0 A rms max
*Actual output power can be calculated by multiplying the current and voltage (read on the 8025 digital panel meter) on each supply output and summing.  **Measured under worst case conditions of high line (129 VAC). Noise drops to 155mV pp @115 VAC  ***Consult factory for 400 Hz operation or DC input option.		

For procedures used to determine product specifications, please see the 8025 Operator's Manual.

### PROTECTION

**Fault Detection:** Max fault duration before shutdown: 40 ms.

#### Watchdog Supply Failure:

+15 V supply; less than +9 V  
 -15 V supply: more positive than -9 V



## OUTPUT PROTECTION

**Overcurrent:** Straight line limiting beginning at 8 A typical on +12 V/+24 V combined and -12 V/-24 V combined. Straight line limiting beginning at 70 A typical on +6 VDC and on -6 VDC

**DC output overvoltage:** +25% above nominal, for all outputs

### DC output undervoltage faults:

+6 V supply: less than +5.7 V  $\pm 0.1$  V  
 -6 V supply: more positive than -5.7 V  $\pm 0.1$  V  
 +12 V supply: less than +11.5 V  $\pm 0.2$  V  
 -12 V supply: more positive than -11.5 V  $\pm 0.2$  V  
 +24 V supply: less than +23.0 V  $\pm 0.4$  V  
 -24 V supply: more positive than -23.0 V  $\pm 0.4$  V

**Thermal Fault:** Main heat sink extrusion temperature 82 degrees C  $\pm 4$  degrees C

**Thermal Warning:** Main heat sink extrusion temperature 71 degrees C  $\pm 4$  degrees C

### AC Line Input Undervoltage Fault

120 V peak in 90-129 VAC rms mode  
 240 V peak in 180-258 VAC rms mode  
 (line source impedance must < 0.2 Ohms)

## INPUT PROTECTION

**Overcurrent:** Fuse protected in both line and neutral conductors

**Fuse rating:** 115 VAC 20 A Slowblow, 220 VAC 10 A Slowblow (accepts either 3AG North American or 5 mm x 20 mm European fuse types)

**Soft Start:** Inrush current is limited to 40 amps peak during first 500 msec after turn on

## MULTIMETER

**Monitor Points:** +6 V, -6 V, +12 V, -12 V, +24 V, -24 V voltage or current

**Resolution:** 3 1/2 digits (0-1999)

**Accuracy:**  $\pm 2.5\%$  of full scale

Note: +24 V current readout includes current for power supply cooling fans, -24 V current readout includes current for crate cooling fans.



## STATUS INDICATORS

Line (green): Power switch ON  
 Load (green): Power applied to installed modules  
 Status (green): No fault conditions  
 Status (red): Fault or user initiated shutdown exists (power not applied to installed modules), or thermal warning exists (power applied to installed modules)  
 Thermal Warning (yellow): Heat sink temperature within 15 degrees C of thermal shutdown  
 Thermal shutdown (red): Power supply temperature too high (supply shutdown)  
 Fan failure (red): Power supply fan not rotating (supply shutdown)

Undervoltage (red): Any of six supply voltages out of tolerance from abnormal loading (e.g., module shorts) or supply failure (supply shutdown)  
 Low AC line (red): Line voltage dropped below operational level (supply shutdown)  
 Monitor (red): Watchdog monitor supply voltage too low for operation (supply shutdown)

**Efficiency:** 70% minimum

**Calculated MTBF:** Greater than 50,000 hours

**Safety:** Designed to meet the requirements of UL 1244 and IEC 348 standards

**Emissions:** Designed to meet FCC Part 15 and VDE 0871 Class "A" requirements.

## ORDERING INFORMATION

Model No.	Description
Model 8025	Rackmount Mainframe (25 bay, 1000 W)
Model 1434A	Rackmount Mainframe (25 bay, 650 W)
Model 8013A	Rackmount Mainframe (13 bay, 400 W)
Model 6010	Manual/GPIB/RS-232 to CAMAC interface
Model 8901A	GPIB to CAMAC interface



---

## Modular Digitizer Systems

---

### More Products from LeCroy...

---

LeCroy Corporation has been providing electronic instrumentation to the research community for over 25 years. Elementary Particle Physics, Nuclear Physics, Fusion and Laser research have led LeCroy to develop individual products and systems for data acquisition, trigger or pattern recognition and high voltage distribution as well as custom high performance components.

#### **HIGH SPEED DATA ACQUISITION AND TRIGGERING SYSTEMS**

Data acquisition systems and architectures must be matched to the intended application. With the variety of standards and interfaces available today, the system designer may choose among variables including capacity, speed, data path width, expandability, flexibility, interconnection protocol, in-line processing and control, access, etc.

LeCroy's products span the spectrum of systems from a single A/D connected to a PC via GPIB, to 100,000 input timing systems based on FASTBUS (IEEE-960). Other control and trigger instruments are based on the VME (IEEE-1014) or CAMAC (IEEE-583) form factors. These standards offer advantages of high density and speed at a low cost per measurement channel.

#### **HIGH DENSITY, HIGH VOLTAGE SYSTEMS**

Remotely programmable, intelligent, high voltage systems are critical elements in systems using sensitive, expensive particle detectors. LeCroy offers HV supplies in several different form factors to suit the demands of the application.

For example, the System 1440 pictured on the right permits the local or remote control of hundreds of individual channels of HV with a rugged, low cost per channel package.

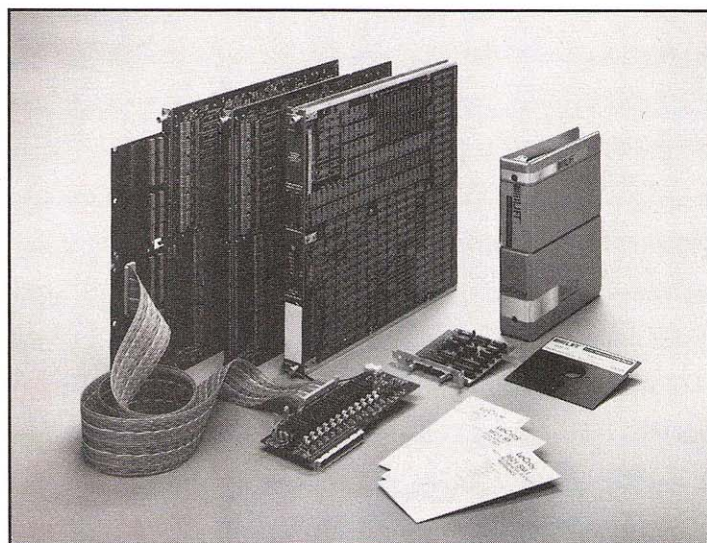

*High density FASTBUS A/D and Time Digitizer Modules with Interface and Software*

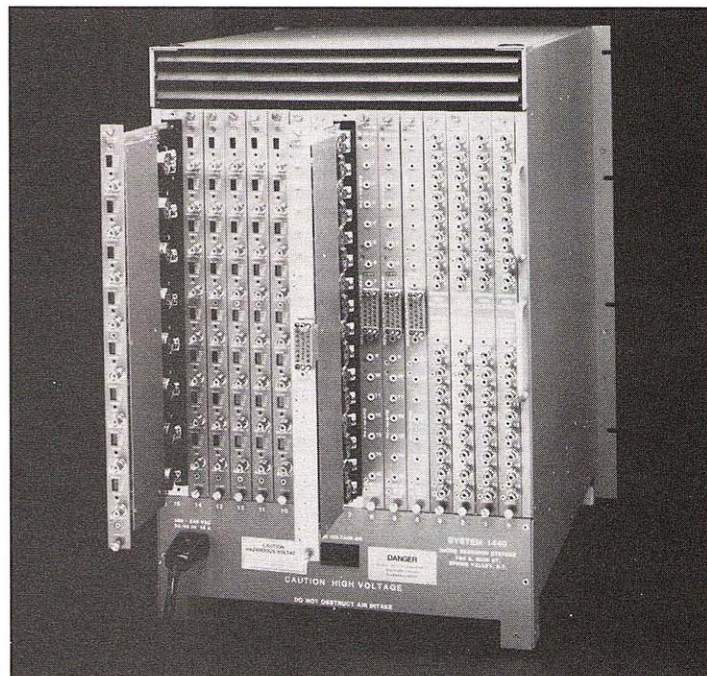

*1440 Programmable High Voltage System*



## CUSTOM MONOLITHIC AND HYBRID COMPONENTS

LeCroy offers high performance components that use advanced hybrid and monolithic technology in DIP or SOIC packaging. Preamplifiers, pulse amplifiers, comparators, programmable digital delays, point-to-point fiber optic links, time digitizers, CCDs, and shift registers are some of the functions available. The micro-photograph shown on the right shows a 4-into-1 charge multiplexer that maintains 15-bit dynamic range and 12-bit resolution.

Details for these products and systems may be found in a separate volume, the **1990 Research Instrumentation Catalog** available from your local sales office.

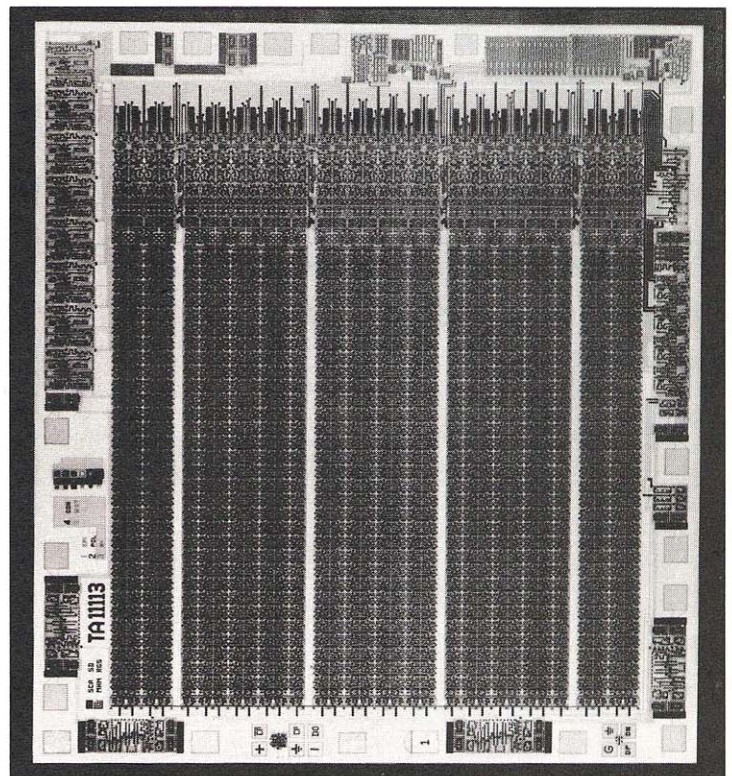

*Model MLL400  
Silicon-on-Sapphire High-Speed Shift Register*



## Introduction to CAMAC

CAMAC is a modular data handling system primarily used for data acquisition. The CAMAC standard covers electrical and physical specifications for the modules, powered instrument housings and backplane. Examples of crates include the LeCroy Models 8025 and 1434A with 25 stations and Model 8013A with 13 stations.

Individual crates are controlled by slave or intelligent controllers. The controllers are tied together with the GPIB (IEEE-488) Standard Interface bus, with a parallel Branch Highway that ends in a Branch Driver or with fiber optic links. LeCroy offers crate controllers that interface directly with the GPIB. Therefore, an entire CAMAC Crate appears as a single instrument. The Model 8901A and 6010 are GPIB/CAMAC interfaces that operate as a "Talkers/Listeners".

With a parallel Branch Highway, the Branch Driver is interfaced directly to a data acquisition computer. Alternatively, tree or parallel data acquisition architectures may be created by connecting secondary CAMAC branches via CAMAC Branch Driver Modules.

CAMAC crates may also be connected in a Local Area Fiber Optic Network via the LeCroy Model 5211A Fiber Optic Serial Link and a serial crate controller. Up to 62 crates separated by a maximum of 500 meters can exchange data at transmission rate of 45 megabytes per second.

Timing and protocol specifications permit up to 1 megaword/sec transfers of 16 or 24-bit words for both the DATAWAY and CAMAC Branch. GPIB timing is usually limited by the host computer and typically runs at 500 kilobytes/sec.

### SECTION 1: INTRODUCTION

CAMAC is an international standard of modularized electronics as defined by the ESONE Committee of the JRC, Ispra. Its function is to provide a scheme to allow a wide range of modular instruments to be interfaced to a standardized multi-

receptacle which, in turn, may be interfaced to a computer. In this way, additions to a data transfer and control system may be made by plugging in additional modules and making suitable software changes. Thus, CAMAC allows information

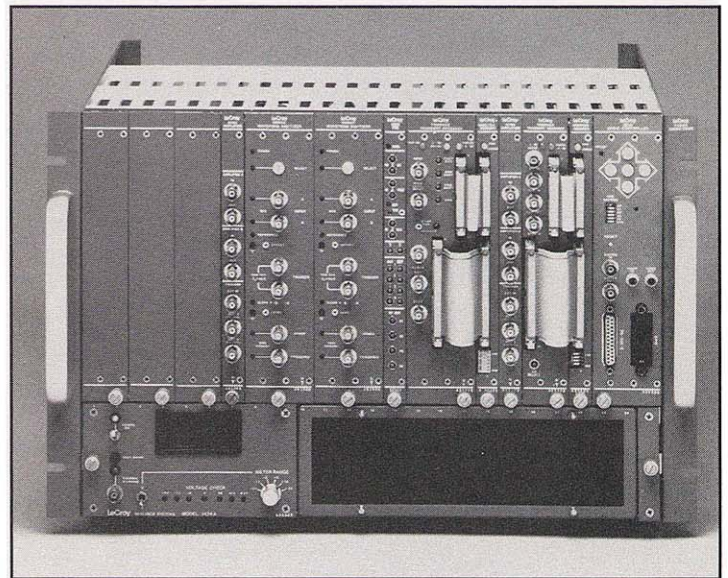

*Full power crate with GPIB interface and waveform digitizer system.*

to be transferred into and out of the instrument modules. CAMAC modules may be plugged into a CAMAC Crate which has 25 STATIONS, numbered 1 through 25. Station 25, the rightmost station, is reserved for a CRATE CONTROLLER, whereas Stations 1-24 are NORMAL STATIONS used for CAMAC Modules (see figure below). Usually, Station 24 is also used by the controller in that most controllers are double width (#2 CAMAC). The purpose of the controller is to issue CAMAC COMMANDS to the modules and transfer information between a computer (or other digital device) and the CAMAC modules.

Data transfer, control functions, and module powering is affected via the DATAWAY. This is a series of bus and individual lines across the back of the crate. The DATAWAY lines include digital data transfer lines, strobe signal lines, and addressing lines and control lines. See Table 3 for a pin allocation chart.



In a typical DATAWAY operation, the crate controller issues a CAMAC COMMAND which includes specifying a station number (N), a subaddress (A), and function code (F) (see Table 1). In response, the subaddress of the module will generate valid command accepted (X response) and act on the command. If this command requires data transfer, the read (R) or write (W) lines will be used. Note that the terms Read and Write apply to the controller, not the module. For example, under a Read command, the controller reads data contained within a module.

## SECTION 2: USE OF THE DATAWAY LINES

Communication with plug-in units takes place through the DATAWAY. This passive multi-wire highway is incorporated in the crate and links the 86-pin sockets to all stations. The bus

lines link corresponding pins at all normal stations and, in some cases, the control station. Individual lines link one pin at a normal station to one pin at the control station. The patch pins have no specified DATAWAY wiring but can be connected to individual points to which patch leads may be attached.

During a DATAWAY operation the controller generates a command consisting of signals on individual Station Number lines to specify one or more modules, signals on the Subaddress bus lines to specify a sub-section of the module or modules, and signals on the Function bus lines to specify the operation to be performed. The command signals are accompanied by a signal on the Busy bus line, which is available at all stations to indicate that a DATAWAY operation is in progress.

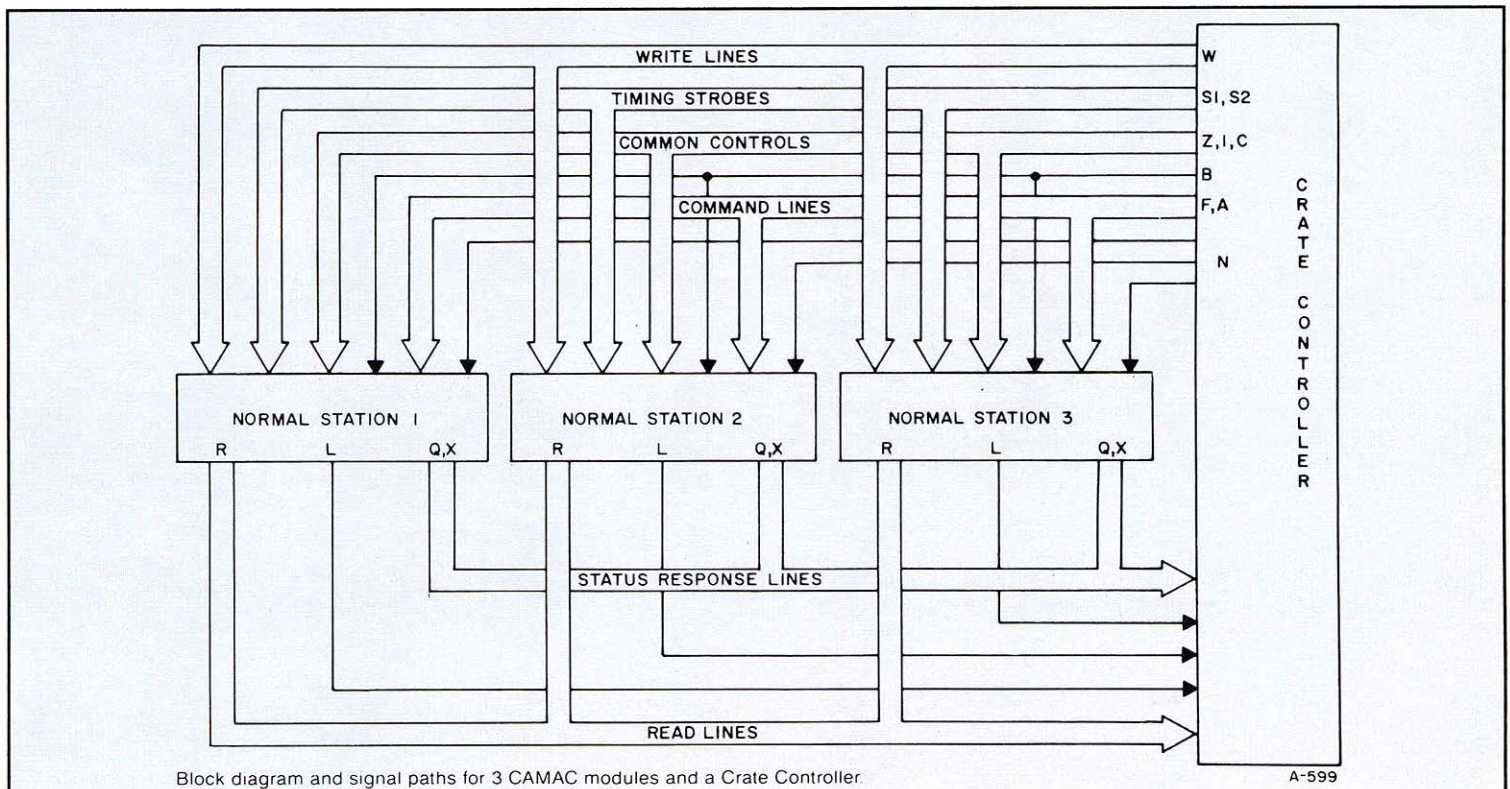

Block diagram and signal paths for 3 CAMAC modules and a CRATE Controller.



When a module recognizes a Read command calling for a data transfer to the controller, it establishes data signals on the Read bus lines. When a controller recognizes a Write command calling for a data transfer to a module, it establishes data signals on the Write bus lines. In addition, regardless of whether there is a transfer on the R or W lines, the module may transmit one bit of status information on the Response bus line.

Two timing signals, Strobes S1 and S2, are then generated in sequence on separate bus lines. The strobes are used to transfer data from the DATAWAY into modules (on Write commands) and into the controller (on Read commands). They may also initiate other actions within the controller and modules.

Whenever there is no DATAWAY operation in progress (indicated by the absence of the Busy signal) any module may generate a signal on its individual Look-at-Me line to indicate that it requires attention. Three common control signals are available at all stations, without requiring addressing by a command, in order to initialize all units (typically after switch-on), to Clear data registers, and to inhibit features such as data-taking.

## 2.1 DEFINITION OF COMMANDS

A command consists of signals on the DATAWAY lines which specify at least one module (by individual station number lines), a subsection of the module or modules (by the four subaddress bus lines), and the function to be performed (by the five function bus lines). The command signals are maintained for the full duration of the operation on the DATAWAY. They are accompanied by a signal on the Busy bus line which indicates to all units that a DATAWAY operation is in progress.

### Station Number (N)

Each normal station is addressed by a signal on an individual station number line (N) which comes from a separate pin at the control station. The stations are numbered in decimal code from the lefthand end as viewed from the front, beginning with Station 1.

### Subaddress (A8, A4, A2, A1)

Different sections of a module are addressed by signals on the four A bus lines. These signals are decoded in the

module to select one of up to sixteen subaddresses, numbered in decimal from 0 to 15.

### Function (F16, F8, F4, F2, F1)

The function to be performed at the specified subaddress in the selected module or modules is defined by the signals on the five F bus lines. These signals are decoded in the module to select one of up to 32 functions, numbered in decimal from 0 to 31. The definitions of the 32 function codes are summarized in the DATAWAY Command Operations section.

### Strobe Signals (S1 and S2)

Two strobe signals S1 and S2 are generated in sequence on separate bus lines. These signals are used to transfer information between plug-in units via the DATAWAY or to initiate operations within units. In either case the specific action is determined by the command present on the DATAWAY. Both strobes are generated during each DATAWAY command operation, and all plug-in units which accept information from the DATAWAY do so in response to these strobes. The first strobe S1 is used for actions which do not change the state of signals on the DATAWAY lines. All units which accept data from the DATAWAY in a Read operation, or in a Write operation do so in response to S1. The second strobe S2 is used to initiate any actions which may change the state of DATAWAY signals, for example, clearing a register whose output is connected to the DATAWAY.

## 2.2 DATA

A common parallel highway is used for all transfers. All information carried by the parallel highway is conveniently described as data, although it may be information concerned with status or control features in modules. Up to 24 bits may be transferred in parallel between the controller and the selected module. Independent lines (Read and Write) are provided for the two directions of transfer.

### The Write Lines (W1-W24)

The controller or other common data source generates data signals on the W bus lines at the beginning of any "Write" operation. The W signals reach a steady state before S1, and are maintained until the end of the operation, unless modified by S2.



## The Read Lines (R1-R24)

Data signals are set up on the R bus lines by the module as soon as a "Read" command is recognized. The R signals reach a steady state before S1, and are maintained for the full duration of the DATAWAY operation, unless the state of the data source is changed by S2. The controller or other common data receiver strobes the data from the R bus lines at the time of the Strobe S1.

## 2.3 STATUS INFORMATION

Status information is conveyed by signals on the Look-at-Me (L), Busy (B), and Response (Q) lines.

### Look-at-Me (L)

This, like the N line, is an individual connection from each station to a separate pin at the control station. When there is no DATAWAY operation in progress (no B present) any plug-in unit may generate a signal on its L line to indicate that it requires attention. When B is present each L signal is gated off the DATAWAY line by the unit which generates it.

A Look-at-Me request can be reset by Clear Look-at-Me, initialize, or by the performance of the specific action which generated the request.

### DATAWAY Busy (B)

The Busy signal is used to interlock various aspects of a system which can compete for the use of the DATAWAY. Specifically, it is generated during DATAWAY command or common control operations. Whenever N is present, B is present, and for the duration of B, all L signals are gated off the DATAWAY lines.

### Response (Q)

The Q bus line is used during a DATAWAY operation to transmit a signal indicating the status of a selected feature of the module. On all Read and Write commands the signal on the Q bus line remains static from the time the command is received until S2. For all other commands the signal on the Q bus line may change at any time.

## 2.4 COMMON CONTROLS

Common control signals operate on all modules connected to them without the need to be addressed separately by a command. In order to provide protection against spurious

signals, the initialize (Z) and Clear (C) signals must be accompanied by Strobe S2.

### Initialize (Z)

The initialize signal has absolute priority over all other signals or controls. It sets all units to a basic state by resetting all registers, whether data or control, to a defined state, and by resetting all L signals and disabling them where possible. Units which generate Z must also cause S2 and B to be generated. Modules which accept Z gate it with S2 as a protection against spurious signals on the Z line.

### Inhibit (I)

The presence of this signal inhibits any activity (for example, data taking). It must not change when B is present or have rise and fall times greater than 200 nsec.

### Clear (C)

This command signal clears all registers or bistables connected to it. Units which generate C must also cause S2 and B to be generated. Modules which accept C gate it with S2 as a protection against spurious signals on the C line.

## 2.5 PRIVATE WIRING

### Patch Leads (P1-P7)

Five pins (P1 to P5) on the 86-way socket at normal stations are not prewired to DATAWAY lines but are freely available for local connections. At the control station, seven pins (P1-P7) are available. Signals on the patch pins must either remain static when B is present or have rise and fall times not less than 20 nsec.

## 2.6 DATAWAY COMMAND OPERATIONS

A Command is composed of signals on the Station Number line or lines, the Subaddress lines and the Function lines. It is accompanied by a signal on the Busy Line. In response to a command, data may be transferred on the Read or Write lines and one bit of status information on the Q line. The two Strobes S1 and S2 must be generated in each DATAWAY command operation to control its timing.

The order in which the commands are described below corresponds to the function codes set out in Table 1. In this table the term "register" is used for an addressable data source or receiver, without implying that it has a data storage property. The function codes allow the registers in a module



to be divided into two distinct sets, known as Group 1 and Group 2. Thus it is possible to operate on more than the basic set of 16 registers selected by the four subaddress lines.

A common feature of all commands is that if the module has a Look-at-Me source which requests a specific command, then the performance of that command should reset the Look-at-Me source.

### **Read Commands (Function Codes 0-7)**

Read commands are identified by the combination  $F_{16} = 0$ ,  $F_8 = 0$  in the function code. They specify that information is to be transferred from a module to a controller via the R bus lines. Data signals are set up on the R bus lines by the module as soon as the "Read" command is recognized, and the appropriate status signal connected to the Q bus line. The R and Q signals reach a steady state before  $S_1$ , and are maintained for the full duration of the DATAWAY command operation unless the state of the signal source is changed at  $S_2$ . The controller or other common data receiver strobesc the data from the R and Q bus lines at the time of the Strobe  $S_1$ .

In order to facilitate reading by sequential addressing, all registers containing data (as opposed to control information) must have consecutive subaddresses starting at subaddress 0. At each of these subaddresses the module generates  $Q = 1$  in response to the appropriate Read command. At the next subaddress in sequence (where there is not a data register) the response is  $Q = 0$ . At all remaining addresses the Q signal may be used to test any feature, subject to the general requirement that the Q signal must be static from the beginning of command until at least  $S_2$ .

### **CODE 0, READ GROUP 1 REGISTER**

This command selects, by subaddress, one register from the first group in the module and transfers the contents of this register to the controller. The contents of the register remain unchanged.

### **CODE 1, READ GROUP 2 REGISTER**

Same as Code 0, except command selects one register from the second group.

### **CODE 2, READ AND CLEAR GROUP 1 REGISTER**

Same as Code 0, except the module register is cleared at time  $S_2$ .

### **CODE 3, READ COMPLEMENT OF GROUP 1 REGISTER**

Same as Code 0, except command transfers the complement of the contents of this register to the controller.

### **CODE 4-7**

Unassigned at this time.

## **2.7 CONTROL COMMANDS (FUNCTION CODES 8-15)**

Control commands are identified generally by  $F_8 = 1$  in the function code. They are divided into two groups by the state of  $F_{16}$ , in this case  $F_{16} = 0$ . They specify that information is not transferred on either the R or W bus lines. However, information may be conveyed on the Q bus line in any of these commands. The signal on the Q bus line may change at any time but is strobed into the controller at time  $S_1$  and may, (except in Code 8), be reset by Strobe 2.

### **CODE 8, TEST LOOK-AT-ME**

This command selects a Look-at-Me source in the module and presents the state of this source on the Q bus line.

### **CODE 9, CLEAR GROUP 1 REGISTER**

This command selects, by subaddress, a register from the first group in the module and clears the contents of this register.

### **CODE 10, CLEAR LOOK-AT-ME**

Same as Code 8, except the Look-at-Me source is cleared at time  $S_2$ .

### **CODE 11, CLEAR GROUP 2 REGISTER**

Same as Code 9, except command selects a register from the second group.

### **CODE 12-15**

Unassigned at this time.

## **2.8 WRITE COMMANDS (FUNCTION CODES 16-23)**

Write commands are identified by the combination  $F_{16}=1$ ,  $F_8=0$  in the function code. They specify that information is to be transferred from a controller to a module via the W bus line. The controller or other common data source generates data signals on the W bus lines at the beginning of the "Write" operation. The module connects the appropriate status signal to the Q bus line as soon as the command is recognized. The



W and Q signals reach a steady state before S1 and are maintained for the full duration of the DATAWAY command operation unless the status of the signal source is changed at Strobe 2. In order to facilitate writing into registers by sequential addressing, all registers which are to contain data (as opposed to control information) have consecutive subaddresses starting at subaddress 0. At each of these subaddresses, the module generates  $Q = 1$  in response to the appropriate Write function. At the next subaddress in sequence (where there is not a data register), the response is  $Q = 0$ . At all remaining subaddresses the Q signal may be used to test any feature subject to the general requirement that the Q signal must be static from the beginning of the command until at least S2.

#### **CODE 16, OVERWRITE GROUP 1 REGISTER**

This command selects, by subaddress, one register in the first group in the module and sets the contents of this register to correspond with the data generated on the W bus lines by the controller.

#### **CODE 17, OVERWRITE GROUP 2 REGISTER**

Same as Code 16, except command selects a register in the second group.

#### **CODE 18, SELECTIVE OVERWRITE GROUP 1 REGISTER**

Same as Code 16, except a separate "mask" register defines which bits in the selected register are set.

#### **CODE 19, SELECTIVE OVERWRITE GROUP 2 REGISTER**

Same as Code 18, except command selects a register in the second group.

#### **CODE 20 — 23**

Unassigned at this time.

### **2.9 CONTROL COMMANDS (FUNCTION CODES 24-31)**

Control commands are identified generally by  $F8 = 1$  in the function code. They are divided into two groups by the state of  $F16$ , in this case  $F16 = 1$ . They specify that information is not transferred on either the R or W bus lines. However, information may be conveyed by the Q bus line in any of these commands. The signal on the Q bus line is permitted to change at any time but is strobed into the controller at time S1 and may, except in Code 27) be reset by Strobe S2. Pre-

cautions must be taken to ensure that information is not lost due to Q signals appearing between S1 and S2.

#### **CODE 24, DISABLE**

This command selects, by subaddress, and disables a feature of the module; e.g., a Look-at-Me source or a data input.

#### **CODE 25, INCREMENT PRESELECTED REGISTERS**

This command adds one simultaneously to the contents of each register in one of 16 groups, defined by the subaddress.

#### **CODE 26, ENABLE**

This command enables the feature of the module selected by the subaddress, e.g., a Look-at-Me source or a data input.

#### **CODE 27, TEST STATUS**

This command selects, by subaddress, any feature of a module other than a source of a Look-at-Me request, and tests it by producing a response on the Q bus line.

#### **CODE 28 — 31**

Unassigned at this time.

See **CAMAC Reference Chart** next page

### **2.10 DIGITAL SIGNAL STANDARDS ON THE DATAWAY**

The potentials for the binary digital signals on the DATAWAY lines have been defined to correspond with those for compatible current sinking logic devices (e.g., the TTL and DTL series). The signal convention has, however, been inverted to be negative logic. The high state (more positive potential) corresponds to logic '0' and the low state (near ground potential) corresponds to logic '1'. Intrinsic OR outputs are thus available from the manufacturers' standard product range, and disconnected inputs go to the '0' state.

It is an essential feature of the DATAWAY that many units may have their signal outputs connected to the Read and Response lines. Outputs onto these lines therefore require intrinsic OR gates. The same principle is extended to other lines (Command, Write, etc.) in order to allow more than one control-line unit in a crate. The Inhibit line may be an exception, since its signals are shaped with a slow rise and fall if they change during DATAWAY operations.



## VOLTAGE STANDARDS FOR DATAWAY SIGNALS

All DATAWAY Signals must conform to the voltage levels as follows:

Pull-up current sources for all DATAWAY bus lines are located in the crate controller (occupying the control station and at least one other station) so as to insure that there is one

and only one current source per line. The minimum pull-up current when the DATAWAY line is at + 3.5 V is defined as 2.5 mA. If the controller generates DATAWAY signals at time intervals near the permitted minima, the pull-up current sources should preferably provide not less than 6 mA when the lines are at this potential. The pull-up for the N signals is located in the unit generating the signals, and for the L signals in the unit receiving the signals, so that the individual lines may be joined or grouped within these units if desired.

The N and L lines are effectively individual lines joining two units (a module and a controller). The Q and R lines generally will have many units generating the signals (say 20) with a few units (maximum four) receiving the signals. The remaining lines (W, A, F, S, B, Z, I, C) will have relatively few units generating each signal (often only one) with the possibility of many units receiving the signals.

## TIMING OF DATAWAY SIGNALS

The sequence of events during a single DATAWAY operation is shown in the Timing Diagram on the following page. The shaded areas indicate the permitted variation of each signal between an ideal square signal and a signal whose transition across the appropriate signal threshold (0.8 V or 2.0 V) satisfies the conditions shown. The signal waveforms for the command and data lines apply to those lines, if any, which take up the '1' state. Other command and data lines may, of course, be in the '0' state during the operation.

The signals on the Busy line and the various signals constituting the command need not occur in exact synchronism, provided their envelope lies within the shaded areas of the diagram. Similar variation is permitted between the signals constituting the data. The broken line indicates the earliest time at which the data signals may change in response to S2.

Key points on these waveforms are indicated by  $t_0$  -  $t_9$ , with the following significance:

Points  $t_0$ ,  $t_3$ ,  $t_6$  represent the initiation of the negative-going of the Command, Strobe 1, and Strobe 2 signals, respectively. They are the times at which the signals would be received from an ideal DATAWAY with no capacitive loading.

Points  $t_9$ ,  $t_5$ ,  $t_8$  represent similarly the initiation of the positive-going edges of the same signals.

## CAMAC Reference Data

### CAMAC FUNCTION CODES

CODE F ( )	FUNCTION	FUNCTION SIGNALS					CODE F ( )
		F16	F8	F4	F2	F1	
0	Read Group 1 Register	0	0	0	0	0	0
1	Read Group 2 Register	0	0	0	0	1	1
2	Read and Clear Group 1 Register	0	0	0	1	0	2
3	Read Complement of Group 1 Register	0	0	0	1	1	3
4	Non-standard	0	0	1	0	0	4
5	Reserved	0	0	1	0	1	5
6	Non-standard	0	0	1	1	0	6
7	Reserved	0	0	1	1	1	7
8	Test Look-at-Me	0	1	0	0	0	8
9	Clear Group 1 Register	0	1	0	0	1	9
10	Clear Look-at-Me	0	1	0	1	0	10
11	Clear Group 2 Register	0	1	0	1	1	11
12	Non-standard	0	1	1	0	0	12
13	Reserved	0	1	1	0	1	13
14	Non-standard	0	1	1	1	0	14
15	Reserved	0	1	1	1	1	15
16	Override Group 1 Register	1	0	0	0	0	16
17	Override Group 2 Register	1	0	0	0	1	17
18	Selective Set Group 1 Register	1	0	0	1	0	18
19	Selective Set Group 1 Register	1	0	0	1	1	19
20	Non-standard	1	0	1	0	0	20
21	Selective Clear Group 1 Register	1	0	1	0	1	21
22	Non-standard	1	0	1	1	0	22
23	Selective Clear Group 2 Register	1	0	1	1	1	23
24	Disable	1	1	0	0	0	24
25	Execute	1	1	0	0	1	25
26	Enable	1	1	0	1	0	26
27	Test Status	1	1	0	1	1	27
28	Non-standard	1	1	1	0	0	28
29	Reserved	1	1	1	0	1	29
30	Non-standard	1	1	1	1	0	30
31	Reserved	1	1	1	1	1	31

Table 1 CAMAC Reference Chart



Points  $t_2, t_{11}$  are the latest time at which the data source is permitted to initiate the negative-going and positive-going edges of the data signals.

Points  $t_1, t_3, t_4, t_7$  represent the latest times at which the received signals are permitted to reach a maintained '1' state, and therefore refer to the last negative-going transition across the + 0.8 V threshold.

Points  $t_6, t_9, t_{10}, t_{12}$  represent the latest times at which the received signals are permitted to reach a maintained '0' state, and therefore refer to the last positive-going transition across the + 2.0 V threshold.

Controllers must initiate the negative-and positive-going edges of the command and strobe signals at intervals not less than those defined by  $t_3, t_5, t_6, t_8$  and  $t_9$ . Modules respond to the command within the most adverse value of  $(t_1 - t_2)$ ; i.e., 100 nsec. The electrical characteristics of the DATAWAY and

connections from it into units must allow signals to rise and fall within the minimum times for  $(t_0 - t_1), (t_2 - t_3)$ , etc. The next DATAWAY operation must not start before  $t_9$ .

The extreme case is shown in the Timing Diagram below with the next operation starting at  $t_9$ ;  $t_9 - t_{12}$  of one operation coincides with  $t_0 - t_3$ , of the next. The command and data signals of one operation may thus be removed while those of the next operation are being established. The Busy signal may be maintained continuously during a sequence of consecutive DATAWAY operations. Under suitable conditions any command or data signals of one operation may thus be removed while those of the next operation are being established. The Busy signal may be maintained continuously during a sequence of consecutive DATAWAY operations. Under suitable conditions any command or data signals which have the same state during successive operations may also be maintained. In the extreme case of successive operations with the same command and data, there could be a complete absence of signal transitions between  $t_0$  and  $t_3$ .

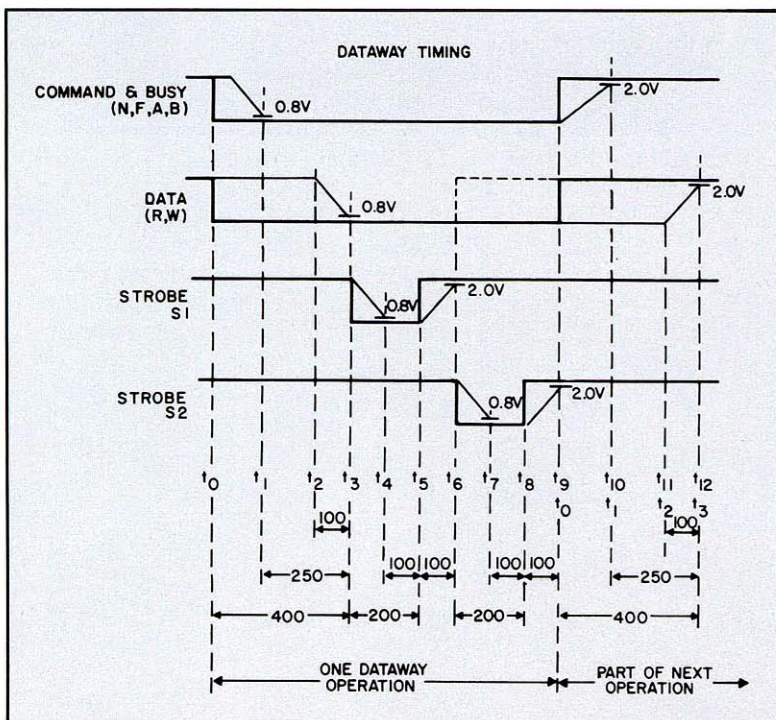

Times given are maximum values in nsec timing of a Dataway operation



# Modular Digitizer Systems

## SECTION 3: POWER SUPPLIES

The voltage tolerances and current loadings are specified in Table 2. The specified tolerances in voltage refer to the voltage measured at the contacts of the DATAWAY sockets and must be maintained under the worst combination of factors such as AC mains voltage and frequency, the maximum current loadings, temperature and the position in the crate of the socket under observation.

Note that the maximum currents stated in Table 2 below are subject to the overall restrictions as follows:

1. The current carried by any contact of the DATAWAY socket must not exceed 3 A.
2. The total power dissipated in a crate, without forced ventilation, must not exceed 200 W.
3. The power dissipation per single-width station should not, therefore, normally exceed 8 W. Under special circumstances however, this rating may be increased to a maximum of 25 W, provided suitable precautions are taken to comply with total power dissipation and current loadings.

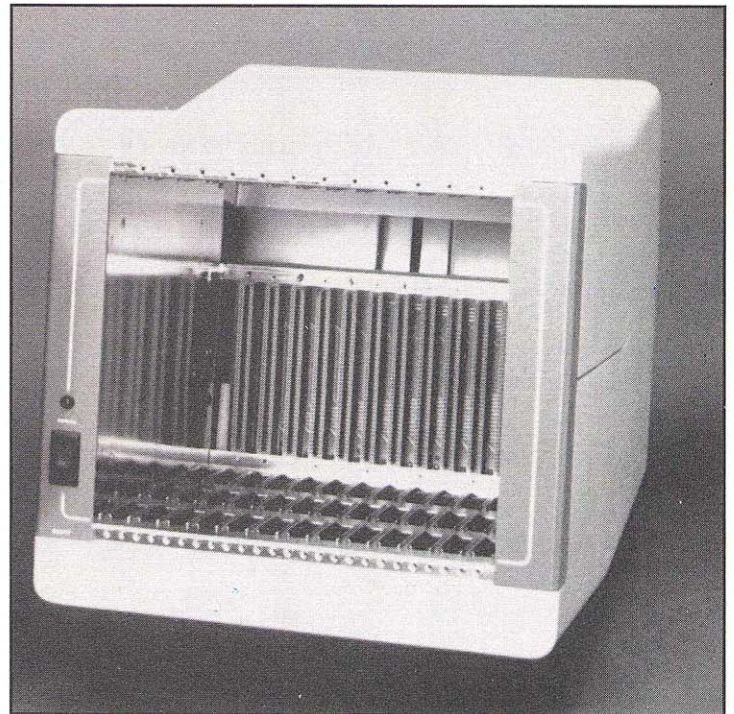

*Benchtop 13-position Mini CAMAC Crate*

### MAXIMUM CURRENT LOADS

SUPPLY VOLTAGE	VOLTAGE TOLERANCE	IN THE PLUG-IN (PER UNIT WIDTH) <small>*See Notes 1 and 3 above.</small>	IN THE CRATE <small>*See Note 2 above</small>
<b>MANDATORY</b>			
+24 V DC	±0.5%	1 A	6 A
+6 V DC	±2.5%	2 A	25 A
-6 V DC	±2.5%	2 A	25 A
-24 V DC	±0.5%	1 A	6 A
<b>Additional (as required)</b>			
+12 V DC	±0.5%		
+12 V DC			

*Table 2. Maximum Current Loads*



Individual patch contact	P1	B	Busy	Bus line	
Individual patch contact	P2	F16	Function	Bus line	
Individual patch contact	P3	F8	Function	Bus line	
Individual patch contact	P4	F4	Function	Bus line	
Individual patch contact	P5	F2	Function	Bus line	
Bus line	Command Accepted	X	F1	Function	Bus line
Bus line	Inhibit	I	A8	Subaddress	Bus line
Bus line	Clear	C	A4	Subaddress	Bus line
Individual patch contact	P6	A2	Subaddress	Bus line	
Individual patch contact	P7	A1	Subaddress	Bus line	
Bus line	Strobe 1	S1	Z	Initialize	Bus line
Bus line	Strobe 2	S2	Q	Response	Bus line
24 Individual Look-at-Me Lines					
L1 from Station 1, etc					
24 Individual Station					
Number lines					
N1 to Station 1, etc.					
- 12 V DC					
- 24 V DC					
6 V DC					
NC					
NC					
Power	Auxiliary -6 V supply	Y1	E	Clean Earth	Power
Bus lines	- 12 V DC	+ 12	+24	+24 V DC	Bus lines
Auxiliary +6 V supply					
0 V (Power Return)					
Y2					
+6					
+6 V DC					
0					
0					
0 V (Power Return)					

Table 3A. Pin Allocation at Control Station.

Bus line	Free Bus line	P1	B	Busy	Bus line
Bus line	Free Bus line	P2	F16	Function	Bus line
Individual patch contact		P3	F8	Function	Bus line
Individual patch contact		P4	F4	Function	Bus line
Individual patch contact		P5	F2	Function	Bus line
Bus line	Command Accepted	X	F1	Function	Bus line
Bus line	Inhibit	I	A8	Subaddress	Bus line
Bus line	Clear	C	A4	Subaddress	Bus line
Individual line	Station Number	N	A2	Subaddress	Bus line
Individual line	Look-At-Me	L	A1	Subaddress	Bus line
Bus line	Strobe 1	S1	Z	Initialize	Bus line
Bus line	Strobe 2	S2	Q	Response	Bus line
24 Write Bus Lines					
W1=LSB					
W24=MSB					
24 Read Bus Lines					
R1=LSB					
R24=MSB					
- 12 V DC					
- 24 V DC					
6 V DC					
NC					
NC					
Power	Auxiliary -6 V supply	Y1	E	Clean Earth	Power
Bus lines	- 12 V DC	+ 12	+24	+24 V DC	Bus lines
Auxiliary +6 V supply					
0 V (Power Return)					
Y2					
+6					
+6 V DC					
0					
0					
0 V (Power Return)					

Table 3B. Pin Allocation at Normal Station.



# Modular Digitizer Systems

## STANDARD DATAWAY USAGE

TITLE	DESIGNATION	CON-TACTS	USE AT A MODULE	TITLE	DESIGNATION	CON-TACTS	USE AT A MODULE
<b>Command</b>				<b>Common Controls</b>			
Station Number	N	1	Selects the module (Individual line from control station).				Operate on all stations connected to them. no command required.
Sub-Address	A1, 2, 4, 8	4	Selects a section of the module.	Initialize	Z	1	Sets module to a defined state. (accompanied by S2 and B).
Function	F1, 2, 4, 8, 16	5	Defines the function to be performed in the module.	Inhibit	I	1	Disables features for duration of signal.
<b>Timing</b>				Clear	C	1	Clears registers. (accompanied by S2 and B).
Strobe 1	S1	1	Controls first phase of operation. (Dataway signals may change).	<b>Non-Standard Connections</b>			
Strobe 2	S2	1	Controls second phase (Dataway signals may change).	Free bus-lines	P1, P2	2	For specified uses.
<b>Data</b>				Patch contacts	P3-P5	3	For unspecified interconnections. No Dataway lines.
Write	W1-W24	24	Bring information to the module.	<b>Mandatory Power Lines</b>			
Read	R1-R24	24	Take information from the module.	+24 V DC	+24	1	Power return
<b>Status</b>				+6 V DC	+6	1	
Look-at-Me	L	1	Indicates request for service (Individual line to control station).	-6 V DC	-6	1	
Busy	B	1	Indicates that a Dataway operation is in progress.	-24 V DC	-24	1	
Response	Q	1	Indicates status of feature selected by command.	0 V	0	2	
Command Accepted	X	1	Indicates that module is able to perform action required by the command.	<b>Additional Power Lines</b>			
				+12 V DC	+12	1	Lines are reserved for the following power supplies
				-12 V DC	-12	1	Low current for indicators, etc.
				Clean Earth	E	1	Reference for circuits requiring clean earth.
				Reserved Y1, Y2	2		Reserved for future allocation.

Table 4 Standard Dataway Usage.



# Fundamentals of Digital Oscilloscopes and Waveform Digitizing

Digital oscilloscopes and waveform digitizers sample signals using a fast analog-to-digital converter (ADC). At evenly spaced intervals, the ADC measures the voltage level and stores the digitized value in high-speed dedicated memory. The shorter the intervals, the faster the digitizing rate, and the higher the signal frequency which can be recorded. The greater the resolution of the ADC, the better the sensitivity to small voltage changes. The more memory, the longer the recording time.

More and more engineers and scientists now recognize the power and precision available from modern digital oscilloscopes and digital waveform recorders. Electronics industry publications feature the benefits and applications of new digitizing instruments in almost every issue. At the same time, traditional oscilloscope manufacturers have cut back development of new analog oscilloscope products.

Why? Because digital oscilloscopes and waveform recorders (both referred to as "digitizers" throughout the rest of this discussion) outperform analog scopes in most applications. Multiple signals associated with intermittent and infrequent events can be captured and analyzed instantly. Complex problems can be quickly identified by viewing waveform data which precedes a failure condition (pretrigger data). Captured waveforms can be expanded to reveal minute details such as fast glitches, overshoot on pulses, and noise. These captured waveforms can be analyzed in either the time or frequency domains.

Most digitizers provide:

- Capture of transient events
- Internally adjustable pretrigger viewing
- Superior measurement accuracy
- Fast measurements with cursors and automatic parametric readouts
- Quick hardcopies on printers and plotters
- Archives for later comparison or analysis
- Waveform mathematics and spectral analysis
- Complete programmability and automatic setups

In contrast, analog scopes require delay lines for pretrigger viewing, cameras and instant-processing film for hardcopy documentation, and CRT grids and visual interpolation for parametric measurements.

## GETTING TO AN INSTRUMENT SOLUTION

The instrument purchaser needs to understand basic digitizer-specifications and architectures to get the right digitizer for the application. For analog oscilloscopes, the primary specifications are simply bandwidth, voltage sensitivity, and accuracy. For digital oscilloscopes, the basic specifications also include sample rate, vertical resolution, and waveform memory length. Some digitizer architectures are optimized for transient signal capture, while others only record repetitive signals.



## KNOW YOUR WAVEFORM

Before you evaluate digitizers, evaluate your signals. Answering these questions regarding your signal and the types of measurements needed will help you choose the right instrument. This preparation will save time and money in the long run.

- 1) Are the signals ever transient in nature (intermittent, single-shot, random, modulating, drifting quickly, or occurring slower than 100 times per second)?
- 2) What is the signal bandwidth?
- 3) How small are the details you need to resolve relative to the peak to peak voltage?
- 4) How accurately do you want to measure voltages and times on the waveforms?
- 5) How long a waveform portion do you want to capture?
- 6) What conditions do you need to trigger on?



- 7) How often should the display update with new waveforms and analyzed results?
- 8) What kinds of analysis do you want?
- 9) How often will you change set ups?
- 10) Do you want to automate tests?
- 11) Do you want to store and recall waveforms?

## 1) Transient Capture

Most analog scopes have a difficult (or impossible) time displaying transient events. In contrast, many digitizers are designed for transient capture.

Three basic digitizer architectures exist. Transient digitizers and Random-Interleaved-Sampling (RIS) digitizers can capture transient signals; sampling digitizers cannot.

All three types can record repetitive signals. Only transient and RIS digitizers record pre-trigger waveform information; sampling digitizers cannot.

Transient digitizers contain an analog-to-digital converter (ADC) and waveform memory. Once "arm"ed, the ADC digitizes the signal continuously and feeds the samples into the memory using circular addressing. After the last memory location is filled, the system overwrites the stored data, starting at the beginning of memory. After a trigger is generated, memory only continues to fill with a user-selected number of post-trigger samples. Then the ADC stops feeding the memory. If the user had selected 100% pre-trigger data, then the ADC would stop sending data as soon as the trigger arrived. If the user selected 100% post-trigger, then the system would fill every memory location one more time and stop. Memory would contain waveform data which occurred after the trigger.

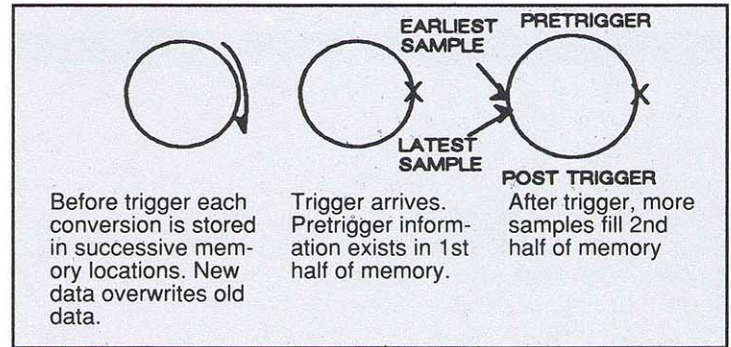

Circular memory addressing for 50% pretrigger setup

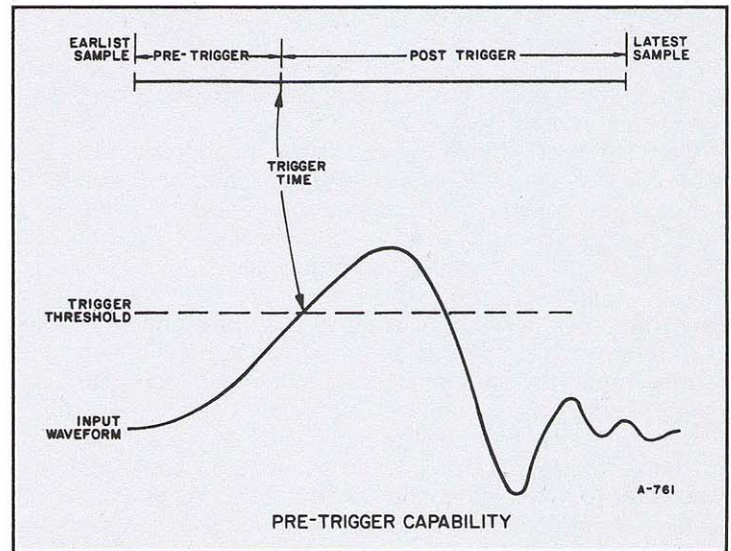

Pretrigger data

RIS digitizers consist of a transient digitizer with the addition of an interleaved mode. For each trigger, the RIS digitizer records a set of waveform sample points. The digitizer interleaves sample point sets from additional triggered acquisitions to construct a detailed representation of the original waveshape.

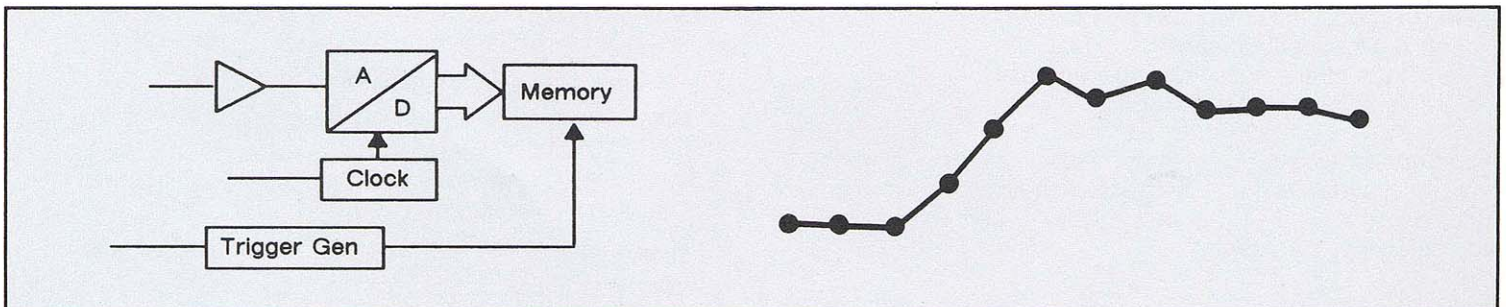

Simple transient digitizer block diagram



Since the digitizer has no way of knowing when the trigger will arrive, the sample clock and the trigger point are asynchronous. Therefore the time between the trigger and the very next sample clock randomly varies from waveform acquisition to acquisition. The RIS architecture uses a time-to-digital converter (TDC) to measure this relationship and accurately interleave successive waveform acquisitions. The TDC has much better timing resolution than the sample interval, so RIS reconstructions can expose details that the transient digitizer alone misses. Yet the RIS digitizer provides user-selectable pretrigger recording, just like the transient digitizer.

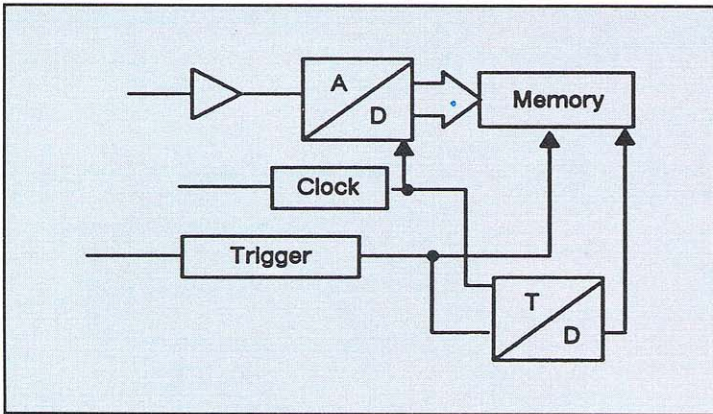

RIS digitizer block diagram

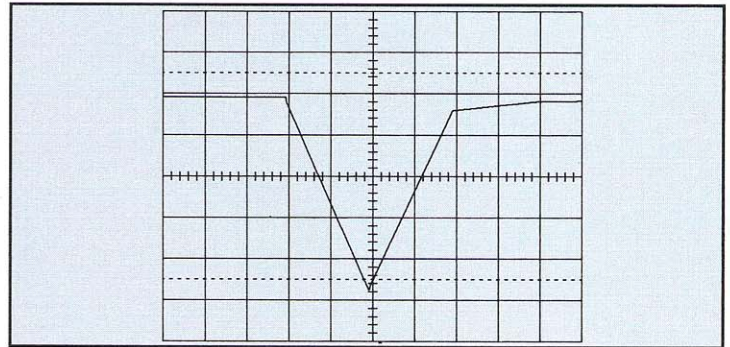

100 MS/sec digitizing of 5 nsec wide pulse

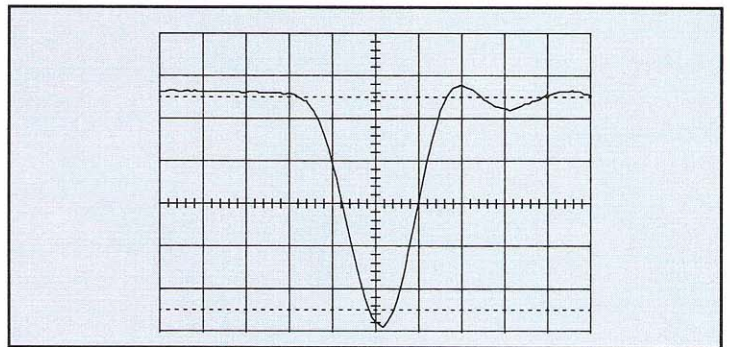

5 GS/sec RIS digitizing of 5 nsec wide pulse

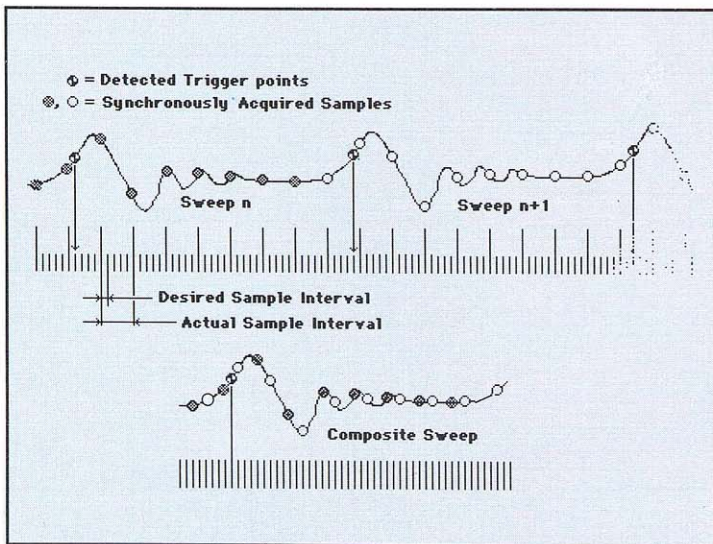

Random Interleaved Sampling (RIS)

Sampling digitizers effectively consist of a sampling head, an ADC, waveform memory, and some timing circuitry. The sampling head stores the voltage and then holds it while the ADC digitizes it. Sampling digitizers acquire just one sample per trigger. For each successive trigger, the timing circuitry delays the time from the trigger to the sample point. For example, for an equivalent sample rate of 1GS/sec, the first sample point would be at the trigger point, the second delayed by 1 nsec, the third delayed by 2 nsec, and so on. Since the sample points are delayed from the trigger point, sampling digitizers cannot record pre-trigger information.

With one sample per trigger, sampling digitizers can take a long time to construct long waveform records. For example, for a 1000 point long record, they require 1000 waveforms to occur, and for a 50,000 point record, 50,000 waveforms.

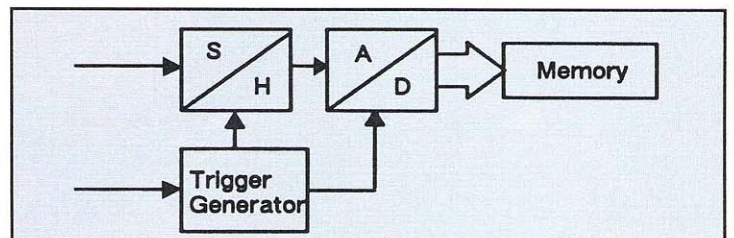

Sampling digitizer block diagram



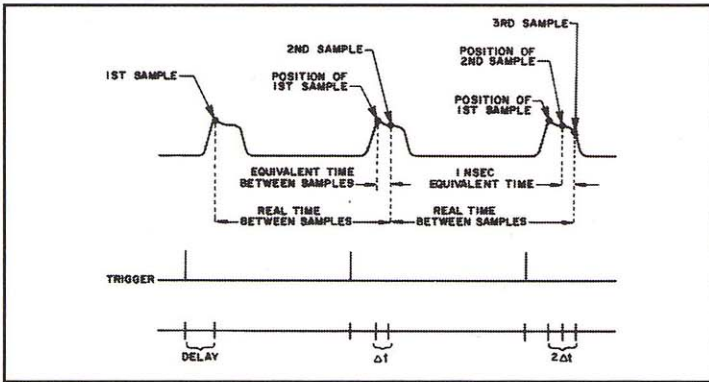

Equivalent Time Sampling with sampling digitizer

## 2) Bandwidth

Bandwidth is an important specification for digitizers, just like analog scopes. The digitizer's input amplifiers and its filters determine the bandwidth.

Fast pulse edges and sharp waveform peaks contain high frequency signal components. To accurately record these edges and peaks, the digitizer must have adequate bandwidth to pass these high frequency signal components with minimal attenuation.

But how much bandwidth is enough? To accurately indicate signal peak amplitudes, the digitizer bandwidth should exceed the signal bandwidth. So first determine the signal bandwidth by estimating the fastest pulse rise time in your signal. Assuming a single pole system response, the signal bandwidth is as follows:

$$\text{Signal Bandwidth} \approx 0.35 / (10\% - 90\% \text{ rise time})$$

The digitizer bandwidth indicates the frequency at which the signal is attenuated by 3 dB (29%). This attenuation occurs gradually, starting at a much lower frequency. Therefore, choose a digitizer with higher bandwidth than the signal.

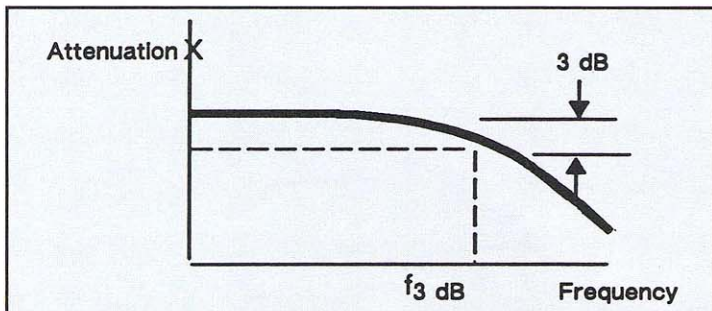

Attenuation occurs within the passband, not just at the cutoff (-3 dB) frequency

Input Frequency (Relative to -3 dB Frequency ( $F_0$ ))	Attenuation	
	dB	%
1.0 $F_0$	-3 dB	-29%
0.5 $F_0$	-1 dB	-11%
0.1 $F_0$	-0.1 dB	-1%

### SAMPLE RATE EFFECTS ON USABLE BANDWIDTH

The digitizer sample rate can degrade the usable bandwidth. To ensure adequate sampling, obtain 4 samples per cycle with  $\sin(X)/X$  interpolation, or 10 samples per cycle with straight line interpolation. If your signal is transient, then look at the single shot sample rate specification; if repetitive, then the faster equivalent sample rate can be used.

Given an ideal digitizer with no noise and given a bandwidth limited signal, Nyquist criteria holds true. Nyquist states that at least two samples must be taken for each cycle of the highest input frequency. In other words, the highest input frequency cannot exceed one half the sample rate. (See LeCroy Application Note "the Fundamentals of Aliasing" for a detailed statement of sampling rate vs. input frequency effects.) Given this scenario, a  $\sin(X)/X$  interpolation algorithm can reproduce exactly the digitized input signal. The  $\sin(X)/X$  algorithm fits curve segments between sample points to create a smooth waveform representation. Unfortunately,  $\sin(X)/X$  interpolation can amplify noise. Since noise exists in real signals and digitizers,  $\sin(X)/X$  should be used cautiously, especially with only 2 samples per cycle.

For more accurate waveform representations, the digitizer should record at least four sample points per cycle of the highest frequency sine component. The additional sample points effectively enhance the signal to noise ratio for  $\sin(X)/X$  interpolation. For example, a 1GS/sec (gigasample per second) sample rate could capture the waveshape of signals up to 250 MHz.

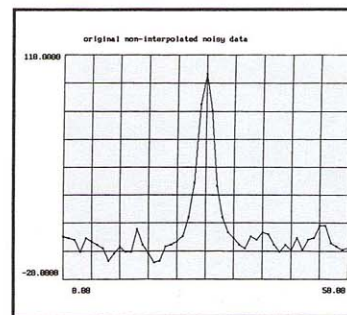

Noisy pulse with straight lines between samples

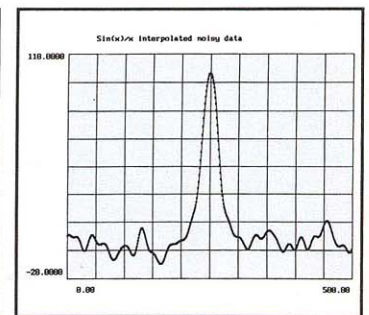

Noisy pulse with  $\sin(X)/X$  interpolation - better for rise time measurements but easy to misinterpret noise as data



Straight line interpolation can deliver accurate waveform representations without the noise amplification caused by curve fitting. For best results, it requires 10 or more samples per cycle.

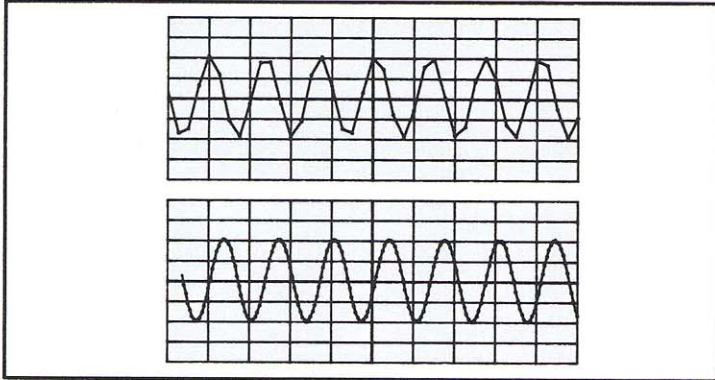

Sine wave digitized at 5 and 25 samples/cycle respectively, with straight line interpolation applied

### MAINTAINING USABLE BANDWIDTH

Long memory allows the scope to maintain the fastest specified sample rate on more timebase settings than a shorter memory scope. Memory determines the maximum possible sample rate at a particular timebase setting as follows:

$$\text{Sample Rate} = \frac{\text{Waveform Memory}}{(\text{Timebase Setting}) \times (\# \text{ CRT Divisions})}$$

For example, if the digitizer contained 50,000 points memory and 10 CRT display divisions and the timebase was set to 5 usec/division, then the sample rate could be as high as 1 GS/sec and still fill the screen.

As the timebase is reduced (more time per division), the digitizer must reduce its sample rate to record enough signal to fill the display screen. By reducing the sample rate, it also degrades the usable bandwidth. Long memory digitizers maintain their usable bandwidth at more timebase settings than short memory digitizers.

### 3) Detecting Small Details

Vertical resolution limits measurement accuracy. It equates to uncertainty of measurement. With digitizers, the analog-to-digital converter, not the CRT display quality, defines resolution. Roughly, digitizers with more than 7-bits can resolve signal details better than visual measurements made with analog scopes.

Vertical resolution and the full scale input range determine how much uncertainty is associated with digitizing a voltage level. Resolution indicates how many quantization levels the ADC can detect across the full scale range.

Digitizers usually contain "flash" type ADCs. Flash ADCs have an integral number of bits of binary output codes to represent the input quantization levels. Thus the commonly used units for resolution are bits. For flash converters, the number of ADC quantization levels is determined by number of bits ( $2^n - 1$ ).

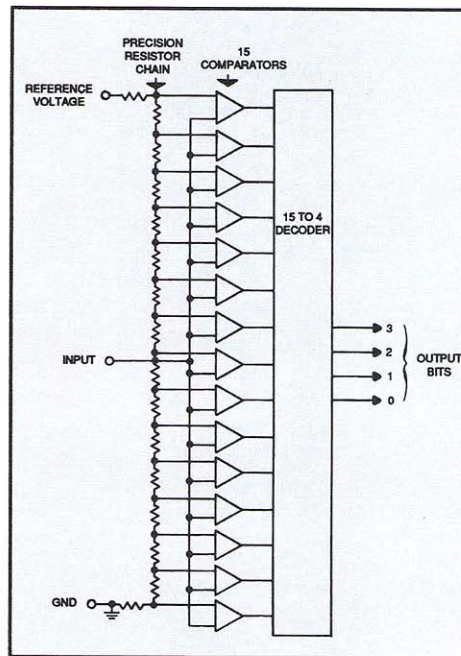

4 Bit flash ADC architecture

Number of Bits of Output Codes	Number of Input Quantization Levels	Resolution as % of Full Scale
6	63	1.6%
7	127	0.8%
8	255	0.4%
9	511	0.2%
10	1023	0.1%
11	2047	0.05%
12	4095	0.02%

Resolution can also be described in terms of voltage sensitivity as follows:

$$\text{Sensitivity} = (\text{full scale range}) / (\# \text{ of ADC quantization levels})$$

For example, an 8 bit digitizer set to 1 V/div, with 8 CRT divisions for full scale, has a sensitivity of 31 mV. Thus, under these conditions, any absolute voltage measurement made with a display cursors has an uncertainty of 31 mV. Any relative voltage measurements made with two cursors has an uncertainty of 63 mV. A 6-bit digitizer under the same conditions could only resolve 125 mV. A 10-bit digitizer could resolve 8 mV.



## AMPLIFIER EFFECTS ON RESOLUTION.

As with analog scopes, the closer the signal amplitude matches the digitizer full scale, the better the digitizer can resolve small signal details. The smaller the input compared to the digitizer full scale, the fewer quantization levels available to record the waveform. For example, if the signal amplitude is one half of the digitizer full scale, then only half of the ADC quantization levels will be used. In other words, if using an N-bit digitizer, only N-1 bits of output codes will be generating when digitizing the waveform. Up to an 8 dB loss of resolution (factor of 2.5) is possible for an arbitrary signal amplitude when using fixed setting amplifiers (X1, X2, X5, etc).

Variable gain amplifiers allow the user to adjust the signal amplitude to match the full scale voltage. Calibrated variable gain amplifiers do the same without loss of measurement accuracy.

## SIGNAL SMOOTHING

Signal smoothing can enhance resolution at the expense of usable bandwidth. Roughly speaking, each 4 - 5 times bandwidth reduction from the Nyquist frequency (1/2 of the sampling rate) provides an extra bit of resolution. If the Nyquist frequency and the analog bandwidth are close in frequency, then this smoothing will reduce the effective bandwidth.

If the Nyquist frequency is much greater than the analog bandwidth, then smoothing will have less effect on the effective bandwidth. For example, the 7200 digitizer delivers 20 GS/sec RIS sampling with a 400 MHz analog bandwidth. Thus Nyquist is 10 GHz. For one bit of resolution enhancement, the effective bandwidth would be reduced to about 2.5 GHz and for 2 bits to about 600 MHz. Combining the analog bandwidth with the smoothed bandwidth will further reduce the system bandwidth.

## SIGNAL AVERAGING

For repetitive signals, averaging numerous digitized waveforms can result in improved signal-to-noise ratio and increased resolution. The more waveforms averaged, the better the results. For waveforms containing at least two least significant digitizer output codes of random noise, averaging improves performance by the square root of the number of waveforms averaged. For example, summation averaging of 16 noisy waveforms results in a four-fold improvement in signal-to-noise ratio and 2 more bits of resolution.

Averaging does not remove systematic baseline noise which occurs at the same place on the waveform from sweep to sweep. Nor does it remove harmonic distortion from slewing or overloaded inputs. Thus, the benefit of averaging becomes negligible when the systematic noise or harmonic distortion becomes the predominant error source. For typical

digitizers, it is reasonable to achieve 2 or 3 extra bits of usable enhancement beyond the ADC resolution (i.e. to get 10 or 11 bits from an 8 bit ADC) from averaging.

Two types of averaging are commonly used, summation and exponential. Summation averaging uses a fixed number of waveform acquisitions. The first point from each waveform record gets summed and divided by the total number of waveforms. The result determines the value of the first point in the averaged waveform. The same procedure determines the averaged values of the second, third, and other sample point positions. Summation averaging is useful when the waveform itself does not change.

Exponential averaging continuously averages and updates the output result. It is useful to show how the noise-free waveform itself changes. Compared to summation averaging, exponential averaging more heavily weights the most recent waveform acquisitions. For stable waveforms, summation averaging provides better signal to noise than exponential averaging on a "per sweep" basis.

All transient digitizers have an uncertainty of 1/2 sample period from the trigger point to the closest sample point. The uncertainty is from waveform to waveform, not within a single waveform. This uncertainty reduces the theoretical averaged bandwidth to 29% below the Nyquist frequency (1/2 the sample rate). If the analog bandwidth is far below Nyquist, the averaging will not reduce bandwidth. If they are close in frequency, then the theoretical averaged bandwidth will reduce the actual system bandwidth.

To prevent further loss of signal bandwidth with averaging, each waveform must be triggered at the same point. Therefore, the noisy waveform itself provides an unstable, jittering trigger source, and therefore, internal trigger should not be used. For best results, a noise-free synchronous event should be used as the trigger source.

## 4) Dynamic Accuracy

Accuracy consists of resolution, precision, and repeatability. Resolution indicates uncertainty associated with any reading. Precision indicates how well the reading matches the actual voltage. Repeatability indicates how often the same reading occurs for the same input.

All digitizers contain numerous measurement error sources which limit precision and repeatability. These errors include:

- Harmonic distortion
- Spurious response
- Differential non-linearity
- Noise (both amplitude and aperture jitter)
- Phase shift with frequency
- Amplitude and offset response with frequency



DC errors indicate how accurately the digitizer will measure static or slow moving signals. The input amplifier, not the ADC, determines DC accuracy. Analog oscilloscopes typically have 3% DC accuracy which matches the display errors. Digitizers can deliver better measurement accuracy, and thus should have better DC accuracy (typically 1-2%).

Dynamic accuracy represents DC accuracy plus numerous other error sources as well. Amplitude non-linearities result in harmonic distortion. These include static (DC) non-linearity, sometimes called integral non-linearity. Dynamic non-linearities, as can be induced by slew-limiting, contribute to harmonic distortion. All of these factors introduce spectral components into the digitized waveform data, at integral multiples of the input frequency. For example, for a 5 MHz sine input, 2nd and 3rd harmonic distortion adds 10 MHz and 15 MHz components to the original signal. Typically, dynamic non-linearities become larger for higher input signal frequencies and levels.

Differential non-linearity is a measure of the uniformity in the spacing of adjacent quantizing levels for a digitizer. For an N-bit digitizer, 2 to Nth power minus one quantizing levels exist. For example, an 8-bit digitizer has 255 quantizing levels. For each digitizer code, the bin-width is defined as the difference between its upper and lower quantizing levels. An ideal digitizer has perfectly uniform, nominal spacing between all quantizing levels. The differential non-linearity is defined as the worst-case variation, expressed as a percentage, from this nominal bin-width. For example, if the LSB voltage is 2 mV and the worst case bin is 3 mV, then the differential non-linearity is 50%. A "missing code" has equal adjacent quantizing levels, or zero bin-width, precluding the possibility of the correct code being output at that input level. Differential non-linearity causes significant errors for small signals.

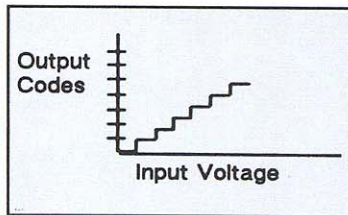

Digitizer error-free quantization (Note: Each ADC output code represents a range of input voltages)

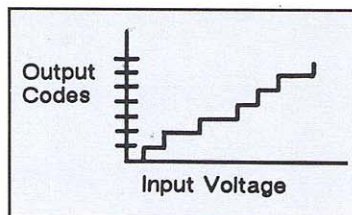

Digitizer quantization with differential non-linearity

Phase distortion means the digitizing system phase shifts the input signal different amounts at different input frequencies. Pulse edges are composed of a series of sine inputs. The pulse waveshape is maintained only if the phase of all the sine components remains constant. Therefore, phase distortion induces erroneous overshoots and rise times on edges.

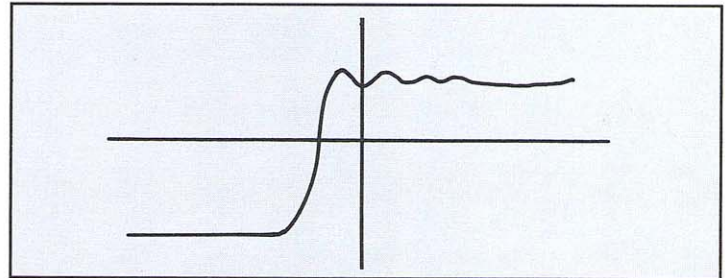

Phase distortion can cause pulse overshoot

Amplitude noise is random or uncorrelated to the input signal. The amplifier associated with the digitizer generates noise into the digitizing process. Noise can mask subtle input signal variations on transient events. For repetitive signals, noise can be reduced by averaging several waveform acquisitions. A high resolution FFT plot of a digitized sine input well indicates noise distribution, but it also indicates quantization noise. Even an ideal digitizer will have an FFT noise floor because of the quantization noise caused by the finite resolution (e.g. an ideal 8-bit digitizer has a -75 dB noise floor).

Aperture uncertainty represents sampling time noise, or jitter on the clock. The amplitude noise induced by clock jitter equals the time error multiplied by the slope of the input signal. The amplitude error increases for fast signal transitions, such as pulse edges or high frequency sine waves. Thus, aperture uncertainty affects timing measurements such as rise time, fall time, and pulse width. Aperture uncertainty has little effect on low frequency signals.

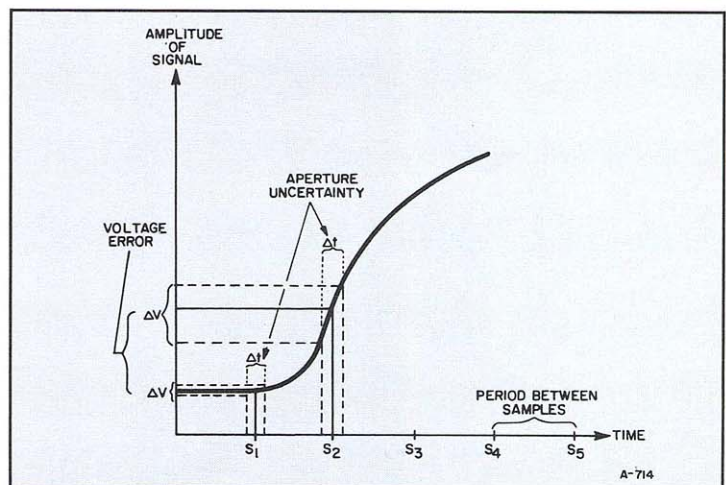

Aperture uncertainty causes errors on fast edges



## EFFECTIVE BITS

A figure of merit called “effective bits” provides a simple but limited means of comparing the accuracy of two digitizers. It indicates dynamic performance. The effective bits measurement includes errors from harmonic distortion, differential non-linearity, aperture uncertainty, amplitude noise, and slewing. The effective bits measurement compares the digitizer under test to an ideal digitizer of identical range and resolution.

Effective bits as a performance indicator has many drawbacks. Effective bits measurements change with input frequency and amplitude. Since the effects of harmonic distortion, aperture uncertainty, and slewing increase at higher signal frequencies and amplitudes, the effective bit values decrease. To represent overall performance under a wide variety of conditions, effective bits should be plotted for various frequencies and amplitudes.

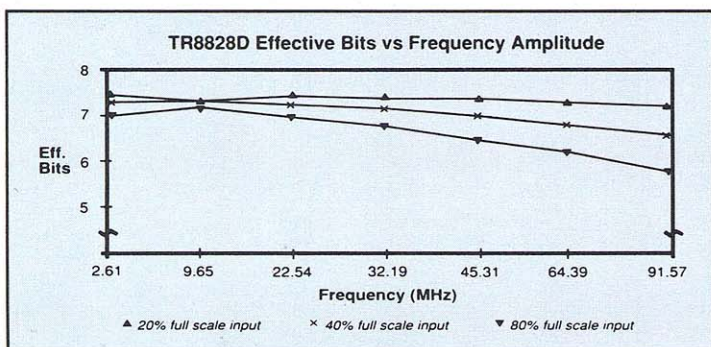

For general purpose comparisons, effective bits should be measured at commonly used frequencies and amplitudes

The effective bits indicator is calculated using sine wave inputs. Therefore, it does not include phase, gain, or offset errors which vary with frequency. It poorly represents worst case errors. It does not indicate which error source contributed most.

## CALCULATING EFFECTIVE BITS

Most manufacturers measure effective bits in similar fashion. See LeCroy application note “How to Measure Effective Bits.” IEEE has drafted a standard (1057 - July 21, 1989) to ensure consistent technique. Basically, it consists of the following method:

- 1) Digitize a pure sine wave.
- 2) Fit the digitized data (amplitude, frequency, phase, and offset) to best match a perfect sine wave.
- 3) Determine the mean squared error (sum of the squares of the difference between the ideal and actual values at each sample point, divided by number of samples).
- 4) Calculate the “lost bits” (derating from ideal):  
$$\text{Lost bits} = \log_2(\text{RMS actual error} / \text{RMS ideal-ADC error})$$

For large input signals which are not harmonically related to

the sampling frequency, the quantization limitation (the resolution of the ADC) generates the RMS error for an ideal ADC. It equals one ADC output count divided by the square root of 12, if we assume the actual input signal is always within +/- 0.5 count of what the ADC output indicates.

- 5) Calculate the effective bits:

$$\text{Effective bits} = \text{digitizer resolution (bits)} - \text{lost bits}$$

Note that steps 2 and 3 in the effective bits calculation are iterative, statistical procedures. Therefore, the effective bits calculation itself will not deliver the same value for two different waveform acquisitions from the same digitizer. A single calculation can indicate erroneously high effective bits. Therefore, a number of calculations should be averaged. For a physical digitizer, the average effective bits will always be less than the digitizer resolution.

Effective bits poorly indicate differential non-linearity. A perfect digitizer with 50% differential non-linearity will only lose 0.1 effective bit. A perfect digitizer with 100% differential non-linearity will only lose 1 effective bit (an ideal 7-bit digitizer is an 8-bit digitizer with 100% differential non-linearity). A histogram of output codes for a pure sine wave input better indicates errors from differential non-linearity. Shown below, the LeCroy 8828D Waveform Digitizer exemplifies good differential non-linearity. The dotted line indicates an ideal digitizer with no differential non-linearity.

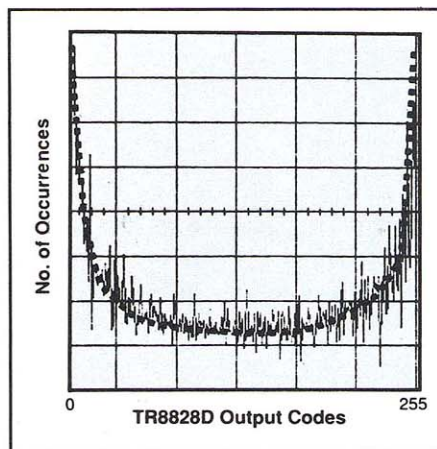

A histogram of output codes for a sine input indicates differential non-linearity better than effective bits does

## 5) Waveform Length

With analog scopes you only get a screen-length waveform representation. With digitizers, the waveform representation can go much beyond the capabilities of the display screen. Memory, not the display screen, determines the waveform record length. Extra long waveform records can be compressed and displayed on one screen (LeCroy uses a proprietary “compaction” algorithm which indicates any glitches contained within the record). The following formula deter-



mines if a particular digitizer can record your entire waveform at a desired sample rate:

$$\text{Waveform Length} = (\text{Memory Length}) / (\text{Sample Rate})$$

Waveform length is in units of seconds, memory is in samples, and sample rate is in samples per second. On all digitizers, the sample rate varies with timebase setting - it does not remain at the maximum specified rate. It should be specified for each timebase setting. If it is, then you can determine the sample rate for a particular waveform record length.

Note, that NOT all digital scopes claiming to have long waveform memory use it all for acquisition - in some cases the memory is shared between acquisition and signal processing. Only the memory applied to acquisition should be used in the above formula.

## WAVEFORM EXPANSIONS

Short-memory scopes (512 to 2048 points) cannot zoom in to expose waveform details since all the memory is displayed at one time. Long-memory scopes can expand sub-sections of the record and display them below the entire compressed waveform. These expansions expose more waveform details.

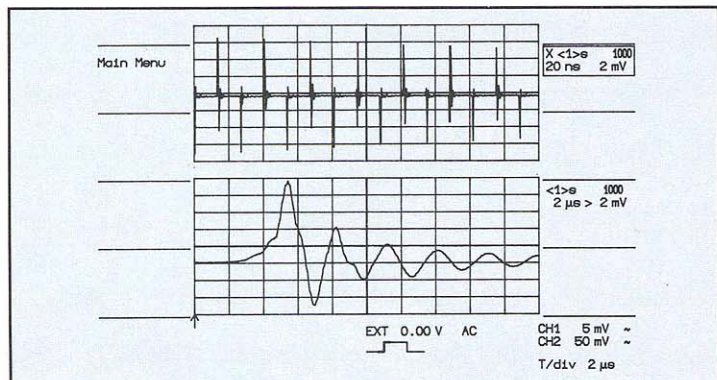

Long waveform memory lets an operator zoom expand to expose waveform details

## SEGMENTABLE MEMORY

Even digitizers with relatively long memory cannot continuously record entire sequences of thousands of events. Such signals often have dead time in between the events. A segmentable memory feature in some digital scopes allows the memory to be filled with just the event, not the dead time. Each time a trigger occurs, the ADC fills one memory segment with waveform information. Thus, eventually several waveforms exist in memory. Without segmentation, the dead time would be recorded along with the pulses and memory would

run out before recording all the pulses.

## 6) Triggering

Triggering allows the operator to identify a particular waveform condition to view. Digitizers now offer all the same triggering as analog oscilloscopes plus many of the capabilities of logic analyzers. Many of the following trigger modes could be incorporated into an analog oscilloscope, but at a loss of pre-trigger information.

Level and slope triggering allows the operator to select a voltage level and either a rising or falling edge. It is available on all oscilloscopes.

Window triggering is useful for capturing glitches or overvoltage conditions. Window triggering occurs when the trigger source signal passes in a positive direction through an upper level or in a negative direction through a lower level. Usually each level is independently selectable.

Hysteresis triggering makes the trigger point less susceptible to noise. It allows a level and slope type trigger to occur only after the signal has crossed a hysteresis level. This level acts as a trigger enable.

Glitch triggering monitors the signal for pulses less than a

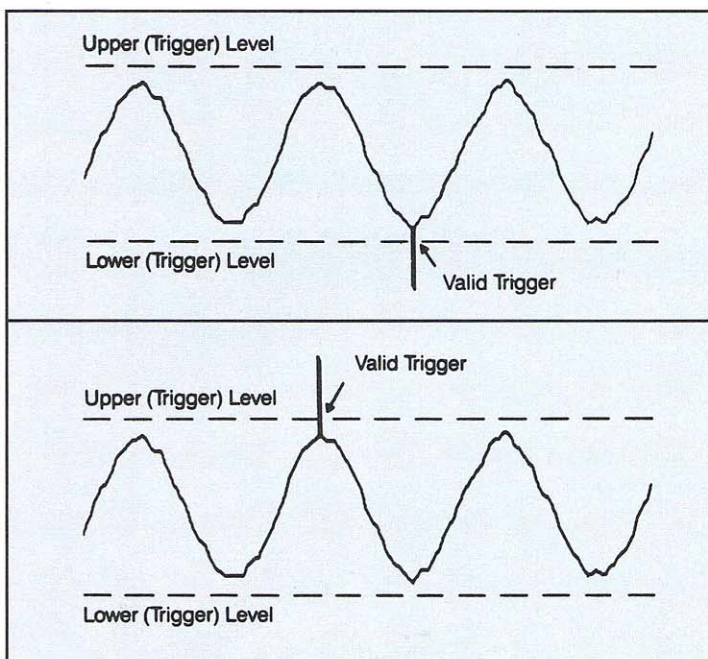

Window triggering



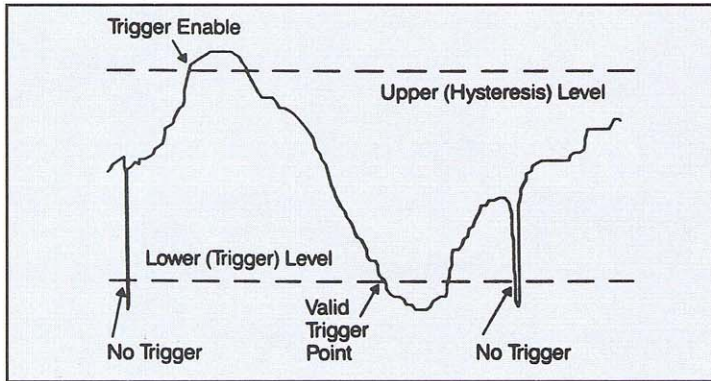

Positive hysteresis triggering

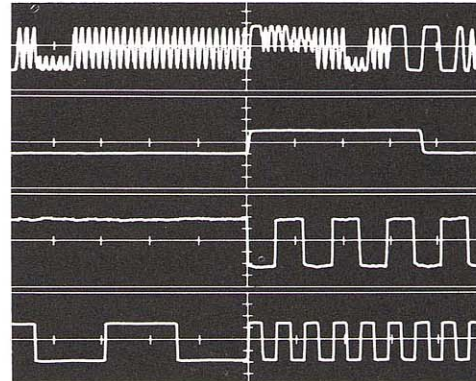

Pattern triggering

specified width. The width is user selectable. Independent glitch trigger circuits can offer triggering on widths less than the digitizing sample interval. Glitch triggering in conjunction with a fast sample rate offers more flexible and accurate waveform capture than a peak detection circuit in conjunction with a slower sample rate. The latter architecture tends to distort the non-glitch waveform portions. Update rates of different digitizer architectures compare roughly as follows:

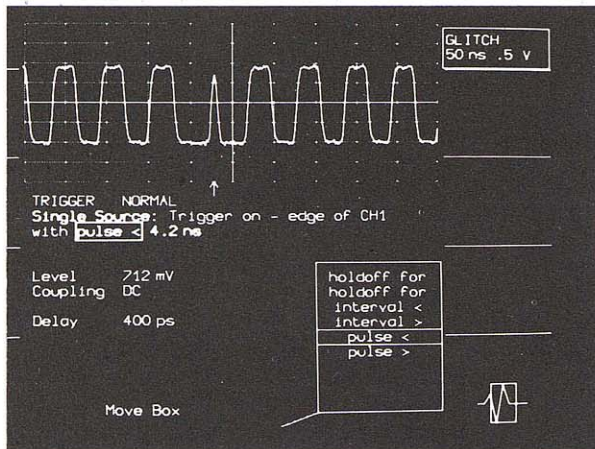

Glitch triggering

Interval triggering monitors the signal for pulses wider than a specified width. The width is user selectable. It is useful for capturing signal dropouts.

Delay by time or by events lets the operator view specific waveform sections without extreme lengths of waveform memory. It is especially useful in conjunction with pattern triggering for testing digital systems.

Pattern triggering lets the user select levels and slopes for several inputs. A trigger occurs only after all conditions are met.

## 7) Display Update Rate

Analog oscilloscopes update 10 to 100 thousand times per second. Digitizers update much less frequently. Fast update rates give digitizers a "live response", or an analog feel. If the response is too slow, the digitizer can miss changing or infrequent events, can be irritating to operate because of the lack of feedback, and can even provide erroneous results. Digitizer architecture, processor type(s) and speed(s), analysis algorithm efficiency, and display algorithm are determining factors in the display update rate.

### DIGITIZER ARCHITECTURES

The digitizer architecture most dramatically affects repetitive-signal display update rates. In general, transient digitizers update the fastest, RIS second fastest, and sampling digitizers slowest. For example, the transient digitizer only requires one waveform acquisition to update the display, whether the waveform is transient or repetitive.

In contrast, if a RIS digitizer samples at 1 GS/sec and the RIS architecture is designed for 20 GS/sec equivalent sample rate, then a minimum of 20 waveform acquisitions are needed to create the effective representation. In reality, the reconstruction requires about 60 waveform acquisitions because of the asynchronous trigger point and sample clock relationship.

Sampling digitizers require one waveform to generate each sample point. To fill 50,000 sample points of memory, sampling digitizers require 50,000 waveforms and 50,000 triggers. The sampling digitizer would take roughly 800 times longer than the RIS architecture just described to update the display. For example, if the RIS design took 100 milliseconds to update, the sampling design would take a minute and 20 seconds!



Update rates of different digitizer architectures compare roughly as follows:

Transient	Interleaved	Sampling Head
R	20R to 600R	R*(# of points memory)

**PROCESSOR SPEED.** Microprocessors exist in almost every digital oscilloscope design. They handle data transfers between memory, the display, any communication ports, and internal storage devices. They accept settings changes from the front panel controls or from the ports. In some cases, they control the waveform acquisition and configure advanced trigger settings. Their efficiency at manipulating data tremendously effects display update rates.

Use of multiple, fast-clocked, 32-bit processors plus dedicated digital signal processors can cause a digitizer to approach real-time update rates, even when extensive signal processing, such as FFT, is applied to the signal. Digitizer designs using a single, slow-clocked, 8-bit processor decrease the manufacturing cost, but can also make the instrument unbearably slow to operate.

**DISPLAY ALGORITHM.** Use of dedicated display processors and simple long-memory compression techniques increase the display update rate. For example, if the CRT can display 2000 waveform points horizontally and memory holds 50,000 points, then only one out of each 25 points can be displayed. A simple display data reduction algorithm is to take every 25th point and display it. Although fast, this technique can miss important signal peaks and glitches. LeCroy's proprietary "compaction" algorithm shows all the details but takes slightly longer to run. High speed 32-bit processors minimize the effect of the additional calculations. Other display algorithms, such as smoothing or  $\sin(X)/X$  interpolation, require many calculations and, therefore, processing time.

## 8) Analysis

One of the greatest advantages of digitizing is the ability to analyze the data. Since the digitizer has converted the analog signal into digital data, either an external computer or the internal digitizer processor can analyze the data. Most digitizers now have a wide spectrum of analyses built in. For additional analyses, PC software packages such as the LeCroy 6920 simplify custom array processing. Let's consider some of the available analyses:

### PULSE PARAMETERS

Cursor readouts allow a user to use the full resolution of the ADC to measure absolute and relative times and amplitudes on a waveform. However, most users commonly measure the

same parameters on a waveform. These parameters include rise time, fall time, pulse width, overshoot, undershoot, peak voltage, peak-to-peak voltage, maximum, minimum, standard deviation, rms value, frequency, and period. The IEEE-194-1977 Standard defines how to make these pulse parameter measurements.

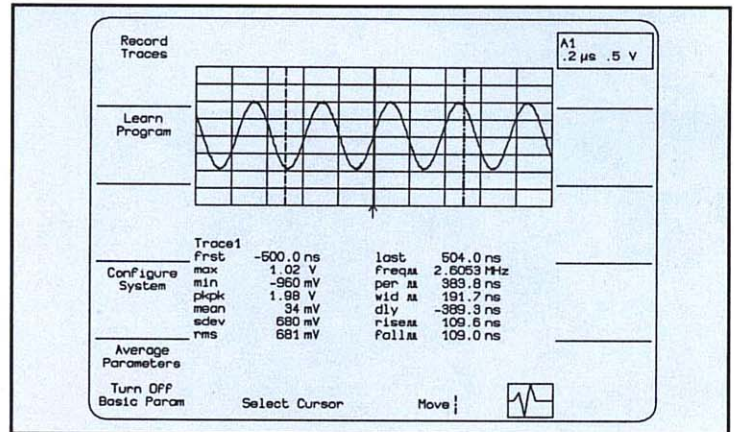

Automatic pulse parameter readout

### WAVEFORM MATH AND ENGINEERING UNITS

Waveform math allows the user to display final answers, rather than raw data. For example, for high voltage research, inputs from voltage and current transformers can be multiplied together to display power. User definable engineering units can indicate Watts or kiloWatts per division. The power trace can be integrated to display energy.

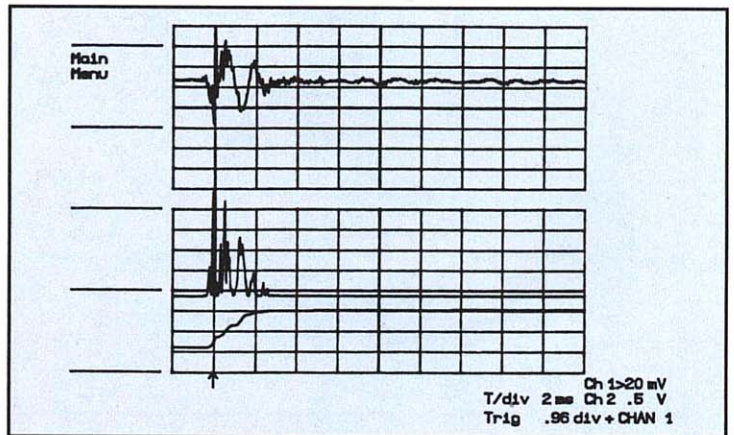

Current and voltage waveforms multiplied to display power



## SIGNAL VARIATION

Digitizers can accurately indicate subtle changes in a repetitive signal via either a roof/floor envelope or a persistence mode (e.g. "eye diagrams"). The roof/floor envelope, also called "extrema", records and displays the maximum and minimum values for each point. Persistence mode displays the last N waveforms acquired, where N is a user selectable number. The persistence mode indicates the density of occurrences, extrema does not.

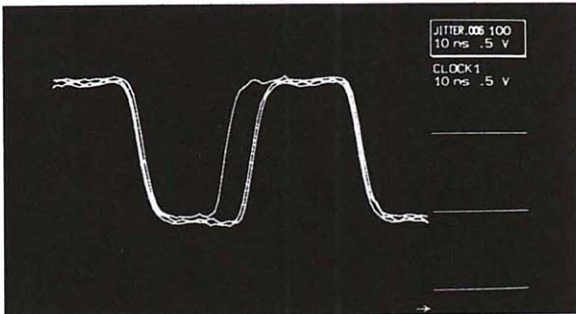

Roof and floor envelopes indicate signal drift

## NOISE REDUCTION

Both averaging and smoothing (filtering) can reduce noise and improve vertical resolution. Averaging requires a repetitive signal, smoothing can enhance a single-shot signal. Sin(X)/X signal interpolation improves resolution, but increases noise amplitudes.

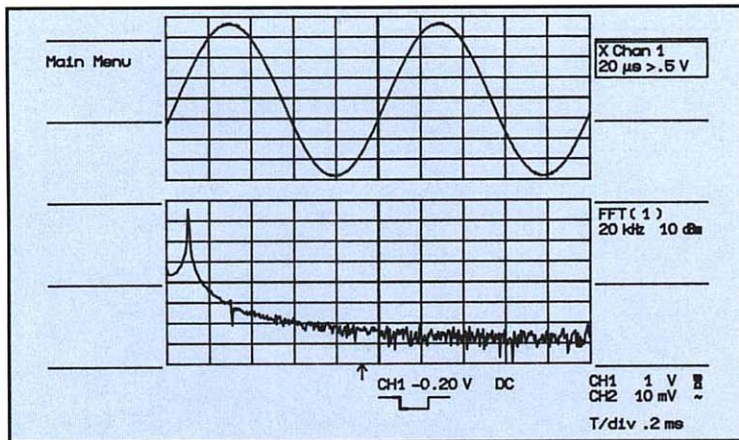

FFT of sine wave shows harmonics not visible in time domain

## FREQUENCY DOMAIN

The Fourier transform converts sampled waveform information into a unique set of sine wave components. The data is usually plotted as frequency vs. amplitude. Two algorithms are common: the discrete Fourier transform (DFT) and the fast Fourier transform (FFT). Practical implementations use the FFT since it is many times faster to calculate. The FFT can expose information not easily visible in the time domain (time vs. amplitude). Ideal uses for FFT analysis include measuring frequency components of communication signals, monitoring drift in a oscillation, etc.

See LeCroy Application Note on "Digital Signal Processing" for more detail on frequency domain analysis.

## 9) Changing Setups

For most digitizers, every function is controlled by an internal microprocessor, even the front panel controls that feel like analog potentiometers. Therefore, every function can be controlled by an external computer via the GPIB. Thus many digitizers can save several instrument configurations for fast recall. Given the advanced triggering setups possible, pushing a single button to recall a complete configuration can save much time.

ACQUISITION PARAMETERS			
	Chan 1	Chan 2	
<b>VERTICAL</b>			
Fixed V/div	.2 V	5 mV	
Total V/div	200 mV	5.00 mV	
Offset	24 mV	-1.40 mV	
Coupling	DC 1 MD	DC 1 MD	
<b>TRIGGER</b>		Time/div	10 ns
Delay	28.22 Pre	Time/pnt	200 ps
Level	- .14 V	Points/div	60
Coupling	DC	Interleaved	
Source	EXT	Sampling	ON
Slope	-	BM-Limit	ON
Mode	SINGLE	# Segments	16
		Per SEGMENT	
Trigger Level has absolute meaning with DC-Coupling only			

Non-volatile storage and recall of complete configurations simplify setup changes



How often will you change set ups? If you repeatedly switch between several set ups, this feature alone can be worth the cost of a digitizer. Most digitizers offer 10 recallable setups. To establish a recallable set up, configure it manually and store it. LeCroy digital oscilloscopes store these setups in non-volatile memory so they can be recalled upon power up. The 7200 digital oscilloscope can store an unlimited number of setups on floppy diskettes.

## 10) Automating Tests

Almost all digitizers can be controlled from a host computer across the GPIB (IEEE-488 Standard Interface bus). The IEEE-488.2 Standard specifies command structure for common digitizers settings, such as voltage range, sample rate, etc. Therefore, digitizers which conform to IEEE-488.2 have easily understood, English-like, mnemonic commands.

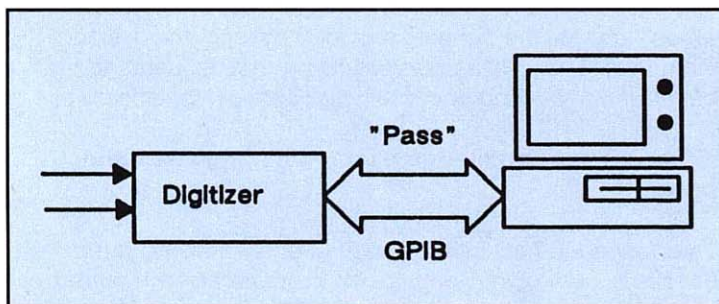

*Local analysis reduces data transfer time*

One of the problems associated with high-accuracy digitizers in a GPIB-based automated test system is the transfer time and storage requirements of long waveform data blocks. Local data analysis within the digitizer allows for transfer of answers, not extensive data blocks. This analysis can be as simple as calculating pulse parameters. Or it could actually consist of PASS/FAIL testing.

A "save-on-delta" type of test compares the actual waveform against a high and low limit. The limits are set as tolerances

compared to a reference waveform. If the acquired data passes outside the limits, the digitizer can take an action (beep, GPIB SRQ, etc.).

The 7200 digital oscilloscope contains a more flexible and powerful test than envelope limits checking. Several different pulse parameters can be measured on the acquired data. Each parameter can have its own tolerance. For example, the digitizer could act if:

- rise time exceeds a 5% tolerance  
AND
- overshoot exceeds 2%  
OR
- frequency varies by 0.5%  
OR
- the third harmonic is larger than -42 dB.

The test conditions are completely programmable, and therefore completely flexible. The actions taken can include printing the data, printing a report, saving the waveform to disk, pulling the GPIB SRQ line, modifying its own setup and taking a different measurement, beeping, turning on an external device, etc.

## 11) Storing and Recalling Waveforms

A few digitizers have built-in mass storage for storing large numbers of waveforms. Nevertheless, the capability is powerful and time saving. The 9400A straps on a laptop computer to allow waveforms to be stored and recalled by name. The 7200 contains a built-in floppy drive and hard disk for storing and recalling waveforms by name or for continuously recording every waveform displayed. This "record" mode can be exited and the stored waveforms scrolled back onto the screen, one at a time.

The floppy uses DOS formatted diskettes. After storing waveforms, the diskette can be removed from the oscilloscope and installed in a PC for direct readout. PC display programs are included with the 7200 oscilloscope. The DOS compatibility eliminates the need for GPIB programming for most laboratory applications.



# Benefits of Long Memories in Digital Oscilloscopes

## Introduction

The strong emergence of digital oscilloscopes in recent years has led to a new way of describing characteristics of these instruments. Unfortunately, the complexity of digital oscilloscopes compared to their analog counterparts has created confusion regarding some important specifications.

By and large, DSO performance is classified according to bandwidth, sampling rate and vertical resolution. However, architectural characteristics such as record length also play a major role in shaping performance and should be given close attention.

### I. Importance of long memories

A major factor in determining the performance of a digital oscilloscope is its record or acquisition length. Record length denotes the number of data points used to sample a waveform and is thus essentially fixed by the size of the acquisition memory. The LeCroy 9450 Digital Oscilloscope, for instance, features 50 kilobyte acquisition memories on each input channel (Figure 1).

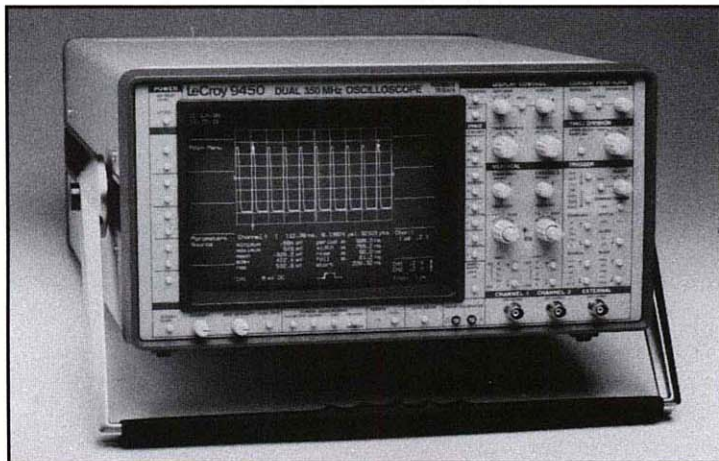

Figure 1: The LeCroy 9450 Digital Oscilloscope features a bandwidth in excess of 350 MHz (-3 dB) and a sampling rate of 400 megasamples/sec in single-shot mode (10 gigasamples/sec interleaved). The instrument features long 50 kilobyte/channel memories. In addition, the 9450's sophisticated trigger considerably exceeds the triggering possibilities available on conventional scopes, making the 9450 a unique instrument for demanding applications.

Nominally identical digital scopes do not necessarily exhibit similar characteristics since instrument specifications may vary depending on the conditions of operation. Bandwidth and sampling rate, for instance, are strongly related to the memory size available in a given digital oscilloscope. A review of how these specifications relate to record length will help to put this in perspective.

### II. Benefits provided by long memories

Long record lengths significantly improve operation. To demonstrate this, a series of examples has been included which illustrate the benefits provided by long acquisition memories. These examples will help potential users to gain a better understanding of overall oscilloscope specifications.

#### a. Benefit 1: Long memories maintain high sampling rates

To understand how memory size affects sampling rates, let us take an example. Suppose for instance that the record length of a scope is fixed to 1K (1,000) samples and that a time base setting of 50 microseconds/div has been selected. What is the effective sampling rate? The sampling interval is given by:

$$\begin{aligned}\Delta T &= (\text{time to acquire } N \text{ samples}) / (N \text{ samples}) \\ &= (10 \text{ div}) \cdot (50 \mu\text{sec/div}) / (1,000 \text{ samples}) \\ &= 500 \text{ nsec}\end{aligned}$$

The corresponding sampling rate is thus:

$$SR = 1 / \Delta T = 2 \text{ megasamples/sec}$$

Suppose now that the memory length is increased from 1K to 50K (50,000). How would this additional memory capacity affect sampling rate? In this case, repeating the same calculations yields a sampling rate of 100 megasamples/sec, i.e., **a 50-fold increase!** Enlarging the acquisition memory does indeed directly improve sampling rate.

The sampling rate quoted by manufacturers always refers to the highest digitizing rate attainable in single-shot mode. It is interesting to observe how the sampling rate, or similarly the



Nyquist rate (half the sampling rate), varies with time base as shown in the figure on the last page. The figure compares the Nyquist rate responses of scopes with 0.5K, 1K, 25K and 50K acquisition memories. The advantage of long memories in improving single-shot bandwidth is clearly noticeable. The 50 kilobyte acquisition memory enables the 9450 to digitize at its fastest sampling rate (400 megasamples/sec) over longer time base ranges than scopes with shorter record lengths. The 9450's Nyquist frequency 200 MHz single-shot bandwidth is maintained down to time base settings as low as 10 microseconds/div, whereas the other models deteriorate in single-shot bandwidth at 0.5 and 1 microsecond/div respectively.

The figure proves that knowing only the maximum sampling rate is inadequate in calculating the effective digitizing rate. Only a combined knowledge of both the maximum sampling rate and the record length provides sufficient information to determine the sampling rate at any given time base.

### b. Benefit 2: Long memories enable events of long duration to be recorded

A frequently recurring situation in digitizing long signals is the problem of maintaining adequate horizontal resolution. Consider for example the problem of digitizing a transient signal which lasts for 10 seconds. The sampling interval is fixed at 1 msec to allow sufficient time resolution. How do these conditions affect record length?

The minimum memory size can be quickly estimated via the following formula:

$$\begin{aligned} \text{Memory size [Sample]} & \\ & \geq (\text{event duration})/(\text{time resolution}) \\ & \geq (10 \text{ sec})/(1 \text{ msec}) \\ & \geq 10,000 \text{ samples} \end{aligned}$$

The 50 kilobyte record length of the 9450 would allow transients lasting up to 50 sec to be recorded with the same time resolution. Similarly, the maximum horizontal resolution achievable could be increased to 200  $\mu\text{sec}$  (10 sec/50,000 samples).

### c. Benefit 3: Long memories help in acquiring hard-to-catch signals

Re-allocation of large storage capacity helps to overcome some structural difficulties associated with digital oscilloscopes. The delay (dead time) separating two consecutive acquisitions is such an example. As these delays arise in

various parts of the system, e.g. trigger section, internal processing, display generation, etc., an exact estimation of the overall delay is difficult to achieve. In applications calling for fast storage of events, knowledge of dead time is crucial in determining whether all events can be properly digitized.

Consider the problem of determining the current intensity variations in a lightning experiment. Experiments show that the intensity distribution occurs in a series of randomly spaced bursts. Such signals pose challenging problems. How can the oscilloscope record all pulses without sacrificing time resolution? For most digital scopes, the dilemma leads to an inherent contradiction. The only way to capture randomly-spaced signals calls for a reduction of the time-base speed to allow the longest possible time-out. This in turn leads to a reduction of time resolution and loss of signal detail.

An effective way to reduce the dead-time danger is segmentation of long memories. Partitioning the memory in a series of adjacent blocks so that each block corresponds to a waveform event minimizes dead time without sacrificing time resolution. The time resolution can thus be preserved without losing valuable data. The 9450, for instance, allows the memory to be segmented in up to 200 segments with an inter-segment dead time shorter than 100 microseconds (Figure 2). Each segment is individually time stamped to facilitate identification of the exact trigger time (Figure 3).

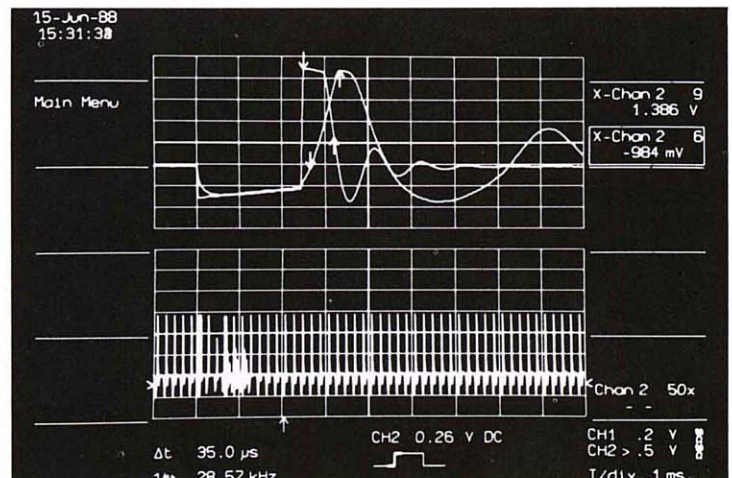

Figure 2: Segmenting long memories allows interesting phenomena to be captured without sacrificing horizontal resolution. The lower trace shows 50 consecutive events acquired on channel 2. The upper trace displays events 6 and 9 magnified by a factor of 50. Both segments are overlapped to contrast their structure.



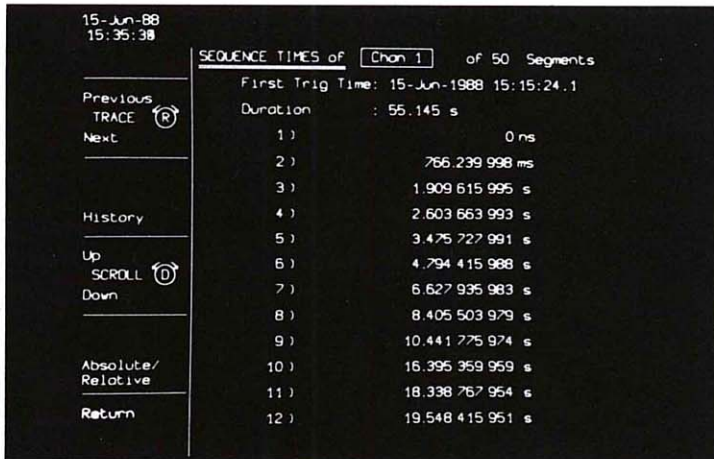

Figure 3: The triggering time of each segment is indicated with 1 nsec resolution. The picture shows the time of occurrence of the first twelve segments referenced to the initial trigger.

#### d. Benefit 4: Long memories minimize the need for analog glitch detectors

Due to the discrete nature of any sampling process, information occurring between samples is ignored. Thus it is possible that certain details in a waveform are missed. To reduce this possibility, a number of manufacturers have included a glitch detector in their instruments. This practice raises some questions: what justifies the need for a glitch detection circuit, and is such a scheme foolproof?

The need for such circuitry becomes obvious if one recalls that the sampling interval increases directly with the time base. Consider an oscilloscope with a record length of 1K. What is the probability of catching a 500 nsec glitch at a time-base setting of 1 msec/div?

$$\text{Sampling rate } SR = \frac{1,000 \text{ points}}{10 \text{ div} \times 1 \text{ msec/div}} = 100 \text{ kilosamples/sec}$$

$$\text{Sampling interval } \Delta T = \frac{1}{SR} = 10 \mu\text{sec/point (10,000 nsec/point)}$$

The probability of catching the glitch is readily calculated to be 5% ((500 nsec/10 usec)X100%), a totally unacceptable figure. Now, suppose that we are using a 9450 with 50K record length at 1 msec/div:

$$SR = \frac{50,000 \text{ points}}{10 \text{ div} \times 1 \text{ msec/div}} = 5 \text{ megasamples/sec}$$

$$\Delta T = \frac{1}{SR} = 200 \text{ nsec/point}$$

The probability of catching the glitch is 100% because it is wider than the sampling interval. Obviously, glitch detection circuits are required only in those instances where the sampling interval becomes prohibitively large. Long memories help to maintain high sampling rates over wide time-base ranges and thus minimize the need for a glitch-capturing facility. In combination with LeCroy's min/max or compacted display method (50,000 points are distributed over 500 pixels), glitch phenomena caught in memory will always be shown.

Glitch detectors present inherent problems that buyers should be aware of. Most glitch detectors basically consist of a comparator followed by a sample and hold circuit. The glitch detector operates as a peak or valley detector tracking min/max signal excursions. The capacitor retains the min or max value of the waveform over the sample interval. Since the capacitor must be reset at the end of each acquisition, a finite time interval exists where the circuitry remains insensitive or blind to signal variations. Because the glitch detector's usefulness depends on the duration of these reset times, glitch detector operation remains restricted to a limited time-base range. On certain oscilloscopes, glitch detectors are actually disabled beyond a given time-base setting. Obviously, the best way to avoid missing glitches is to maintain high sampling rates. **Long records play a crucial role in providing this capability.**

Another, and even more disturbing aspect of glitch detection concerns the distortion induced in waveform reconstruction. Since min/max detectors retain only extrema values, waveform representation consists of a series of discontinuous plateaus for a signal which exhibits wide variations. Glitch detector operation inherently precludes faithful waveform reconstruction.

In addition to these problems, a glitch occurring while the oscilloscope is involved in internal data processing will be ignored, as glitch detectors can only operate during waveform acquisition. LeCroy's long memories minimize dead time, and its new glitch detection mechanism FASTGLITCH lets the 9450 actually trigger on a glitch. Once adjusted, this facility detects glitches even if they are narrower than the sampling interval of 2.5 nsec, and triggers on them irrespective of when they occurred. An example of FASTGLITCH triggering is shown in Figure 4.



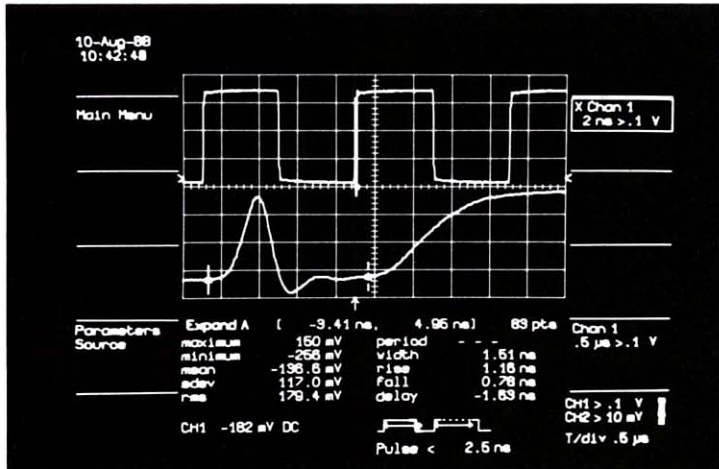

Figure 4: FASTGLITCH trigger mode is used to trigger on a glitch 1.51 nsec wide which occurs before the leading edge of a 500 kHz clock signal (top trace, see trigger arrow at the bottom of the grid). Fast sampling rate, automatic pulse parameters and horizontal expansion by 250 times (lower trace) all combine to reveal the signal details.

## e. Benefit 5: Long memories improve accuracy of pulse waveform parameters

The 9450 possesses an automatic pulse measurement capability. At the touch of a button the instrument will measure up to 10 different parameters and display the results following each new acquisition. Parameters include min, max, mean, standard deviation, RMS, period, width, delay, rise and fall time, and are calculated in full compliance with the IEEE Std 181-1977 official recommendation.

To understand why long memories provide better accuracy, consider the determination of the top and base lines, two essential elements in measuring pulse waveform parameters. The IEEE standard requires that a probability density histogram be set up to identify the two largest peaks (Figure 5). Since the 9450 uses 50 kilosamples by default to estimate these levels, the number of samples falling within the 255 histogram bins is large enough to provide a representative picture of the waveform. Because the uncertainty in estimating the centroid of each level is inversely proportional to  $\sqrt{N}$ , long memories help to reduce statistical fluctuations related to a limited amount of data. **Long memories contribute to providing more accurate pulse parameter estimations.**

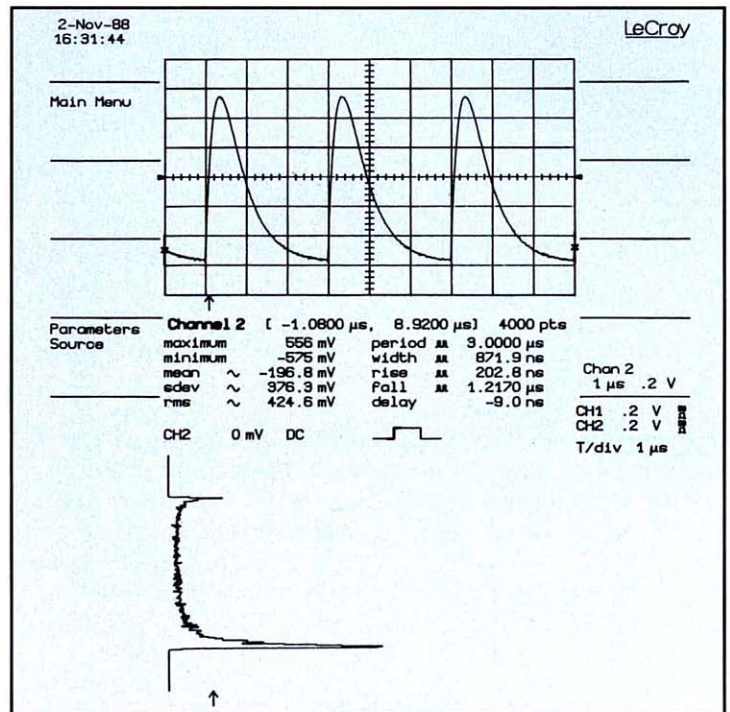

Figure 5a & b: Determination of top and base levels is achieved by histogramming the frequency of occurrence of the waveform data (Fig. 5a) and calculating the centroids corresponding to the two most prominent bin clusters (Fig. 5b). Accuracy improves as the number of samples increases.

## f. Benefit 6: Long memories help to minimize waveform reconstruction distortion

A strict application of sampling theory calls for an infinite summation to construct a signal  $f(t)$  from its samples

$$f(t) = \sum_{k=-\infty}^{\infty} f(kt) \operatorname{sinc}((t-kT)/T)$$

where  $\operatorname{sinc}(x) = \sin \pi x / \pi x$

This summation cannot be carried out in practice because of the finite number of samples. A number of different interpolation techniques are employed to reconstruct sampled signals. Most commonly found interpolation techniques include linear, sine, sinc ( $x$ ). All of these interpolation schemes produce some reconstruction distortion.



# Technical Tutorial

For a signal band-limited to  $f$ , the truncated sinc ( $x$ ) approximation yields an error of  $\sqrt{(2 \cdot E \cdot f)}$ , where  $E$  denotes the energy.[1]

The power spectrum error resulting from linear interpolation of samples is proportional to  $\text{sinc}^4(T \cdot f)$  (where  $T$  is the sampling interval) [2]. Linear approximation provides good results if the sampling rate is high enough. The amount of reconstruction distortion is minimized in the 9450 because of its high sampling rate, or equivalently because of its acquisition length.

### III. Conclusion

To determine whether a scope will fit one's application, a clear understanding of the operational mode and specifications of digital oscilloscopes is required. In contrast to analog oscilloscopes, variations of quantities such as bandwidth, sampling rate or resolution can be significant. Oscilloscopes with nominally equivalent specifications may differ widely in true performance and become totally inadequate in certain applications.

Besides the above specifications, record length plays a major role in determining performance. Long records enhance the performance of digital scopes to a great extent, giving higher sampling rates, higher single-shot bandwidth, longer record times, vastly reduced aliasing effects, substitution for inaccurate glitch detectors, improved signal-to-noise ratios, wide dynamic range in the frequency domain, signal processing accuracy, etc. Long acquisition memories benefit digital oscilloscope users. The foregoing explanations should assist potential buyers to quickly narrow their choice.

[1] A. PAPOULIS, Signal Analysis, McGraw-Hill, New York, 1977, p. 142.

[2] F. de COULON, Theorie et Traitement des Signaux, Vol. VI < Georgi, Lausanne, 1984, p. 298-299.

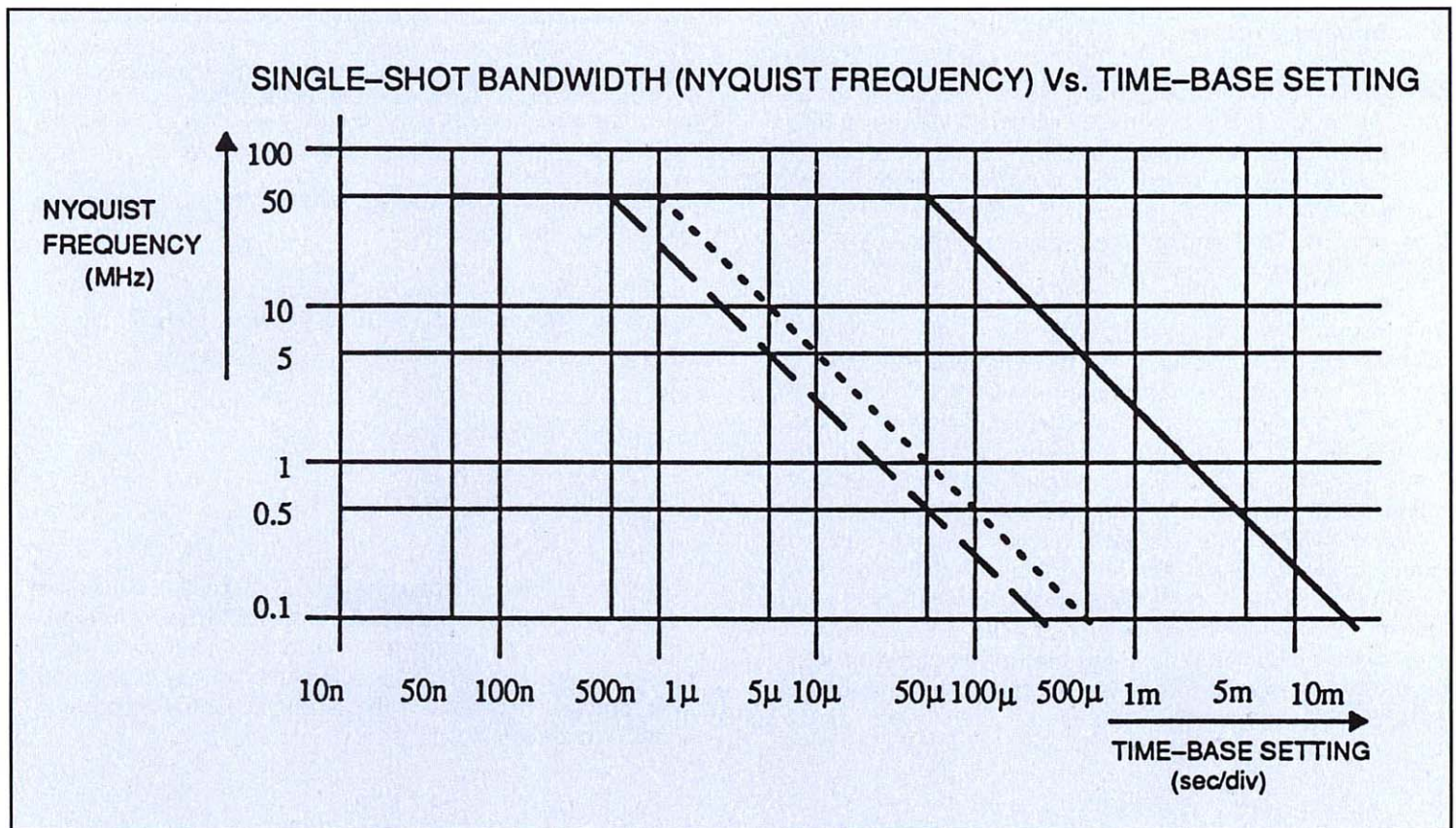



# High Resolution Modes In Digital Oscilloscopes

## What is High Resolution?

Quite often the high sampling rate available in some digital oscilloscopes (DSO's) is higher than is actually required for the bandwidth of the signal being analyzed. This oversampling can be used to advantage, especially in scopes with long waveform memories, by filtering the digitized signal in order to increase the effective resolution of the displayed trace. This is similar to smoothing the signal with a simple moving average filter, except that it is more efficient in terms of bandwidth, and has better passband characteristics. It therefore finds application in situations where averaging of successive traces would be useful but can't be employed because the signal has single-shot characteristics.

**The Advantages of High Resolution** -Two subtly different characteristics of the instrument are improved by the High Resolution filtering:

1. In all cases the resolution (i.e., the ability to distinguish closely spaced voltage levels) is improved by a fixed amount for each filter. This is a true increase in resolution which occurs whether or not the signal is noisy, and whether or not it is a single-shot or a repetitive signal.
2. The signal-to-noise ratio (SNR) is improved in a manner which depends on the form of the noise in the original signal. This occurs because the High Resolution filtering decreases the bandwidth of the signal, and will therefore filter out some of the noise.

**Implementation of High Resolution on LeCroy scopes** - The LeCroy 9420, 9424, 9450 and 7200 Series DSO's implement a set of linear phase finite impulse response (FIR) filters, optimized to provide fast computation, excellent step response and minimum bandwidth reduction for resolution improvements of between 0.5 and 3 bits in 0.5 bit steps. Each 0.5 bit step corresponds to a bandwidth reduction by a factor of two, allowing easy control of the bandwidth/resolution trade-off. The parameters of the six filters available in these scopes are given in Table 1.

Resolution Increase (Enhancement)	-3 dB Bandwidth (x Nyquist)	Filter Length (samples)
0.5	0.5	2
1	0.241	5
1.5	0.121	10
2	0.058	24
2.5	0.029	51
3	0.016	117

Table 1. Parameters of the 9450/20/24's FIR High Resolution Filters.

The filters used are low pass filters, so the actual increase in SNR obtained in any particular situation will depend on the power spectral density of the noise present on the signal. The filters will give the same SNR improvement ratio as their resolution improvement ratio if the noise in the signal is white, i.e., evenly distributed across the frequency spectrum. If the noise power is biased towards high frequencies then the SNR improvement will be better than the resolution improvement. Whereas, if the noise is mostly at lower frequencies, the improvement may not be as good as the resolution improvement. The improvement in the SNR due to the removal of coherent noise signals (for example, feed-through of clock signals) depends on whether the signal is in the passband of the filter or not. This can easily be deduced by using the spectrum analysis option of the digital scopes.

As an aid to choosing the appropriate filter for a given application, the High Resolution menu (see Figure 1) indicates the -3 dB bandwidth of the current filter in two ways. Firstly, it is given as a percentage of the Nyquist frequency, and secondly, as the actual frequency that this corresponds to for the timebase setting of the current waveform.



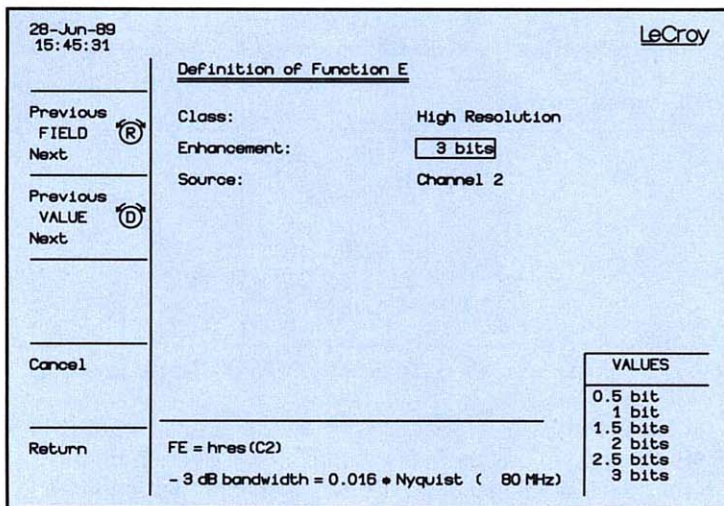

Figure 1: The enhanced resolution menu in LeCroy's 9420/24/50.

The filters used for the High Resolution function have an exactly linear phase response. This has two desirable properties. Firstly, the filters do not distort the relative position of different events in the waveform, even if the frequency content of the events is different. Secondly, by using the fact that the waveforms are stored, the delay normally associated with filtering (between the input and output waveforms) can be exactly compensated for during the computation of the filtered waveform.

All filters have been implemented to have exactly unity gain (at low frequency). Therefore, High Resolution should not cause overflow if the source data were not overflowed. If part of the source trace has overflowed, filtering will be allowed, but it must be remembered that the results in the vicinity (within the length of the filter impulse response) of the overflowed data will be incorrect. This is permitted because in some circumstances an overflow may be a spike of only one or two samples. The energy in this spike might not be sufficient to significantly affect the results, so it would be undesirable to disallow the whole trace in this case.

**When should High Resolution be used?** - There are two main situations for which high resolution is especially useful. Firstly, if the signal is noticeably noisy (and measurements of

the noise are not what is desired), the signal can be "cleaned up" by using the High Resolution function. Secondly, even if the signal is not particularly noisy, but high precision measurements of the waveform are required (perhaps when using Expand with high vertical gain) then High Resolution will increase the resolution of the measurements.

In general, High Resolution replaces the Averaging function in situations where the data record has a single-shot or slowly repetitive nature and averaging cannot be used.

The following examples illustrate uses of the High Resolution function in these situations.

Figure 2 shows the effect of High Resolution on a single-shot mechanical vibration, where the trace is scaled according to the event which caused the trigger, but the small vibrations in the tail of the response are also of interest. The lowest grid shows the original signal, the bottom trace being the expansion (x5 vertically, x10 horizontally) of the trace above. The expansion is of approximately the 7th time division from the left. The upper grid shows the same signals after 3-bit High Resolution enhancement. Without High Resolution, the small oscillations were completely lost in noise, but with it the approximately 1 mV oscillations can easily be seen and measured.

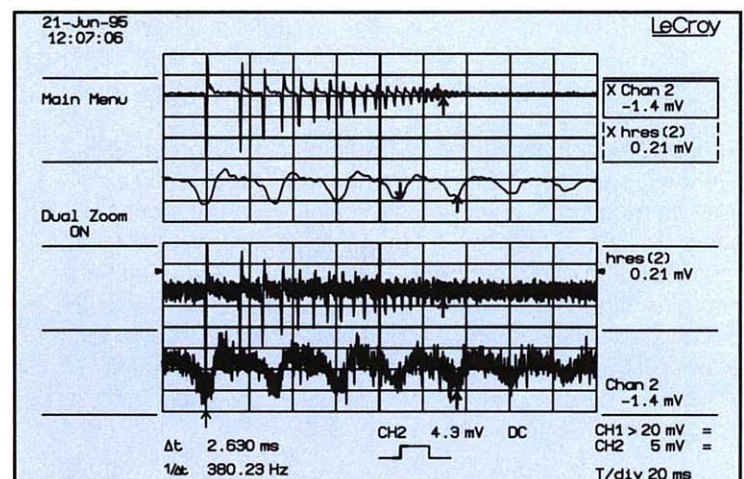

Figure 2: Mechanical vibrations analyzed in detail with resolution enhanced by 3 bits.



For the above case the filtering effect of the High Resolution function is also shown in the frequency domain by the FFT function (available as an option). Figure 3 shows the power spectrum of the signals in Figure 2. The upper trace is the spectrum of channel 2, and the lower trace is the spectrum of Function E, i.e., channel 2 after High Resolution filtering. The 3.0 bit enhancement filter has a -3 dB bandwidth of 0.016 times the Nyquist frequency, which is about 1/6th of a horizontal division. The filter removes energy from the signal above this frequency. The residual spikes in the lower trace at the -80 dB level are due to the processing noise (finite arithmetic effects) of long FFT computations.

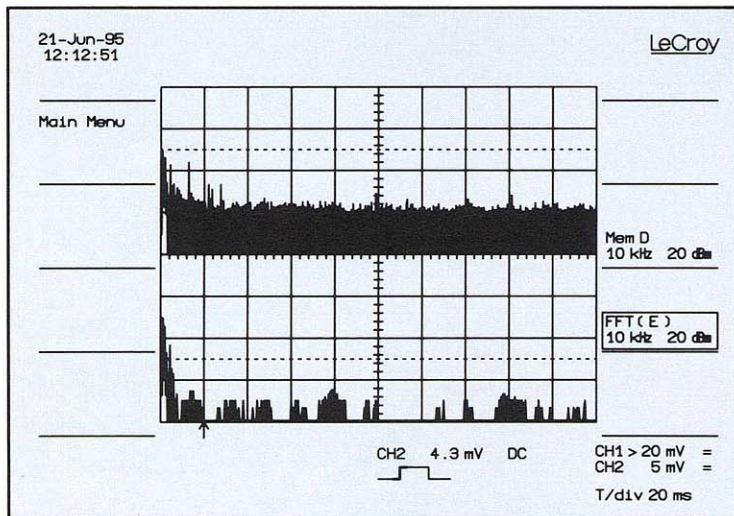

Figure 3: Frequency domain display of the mechanical vibration waveforms of Fig. 2.

Figure 4 shows a relatively noise-free step response (upper trace). The middle trace is the expansion (x5 vertically, x25 horizontally), of this step response in the region of the initial peak. The lower trace, which is the expansion of the same step response after 1-bit High Resolution filtering, clearly shows the advantage of even a modest resolution enhancement of 1 bit.

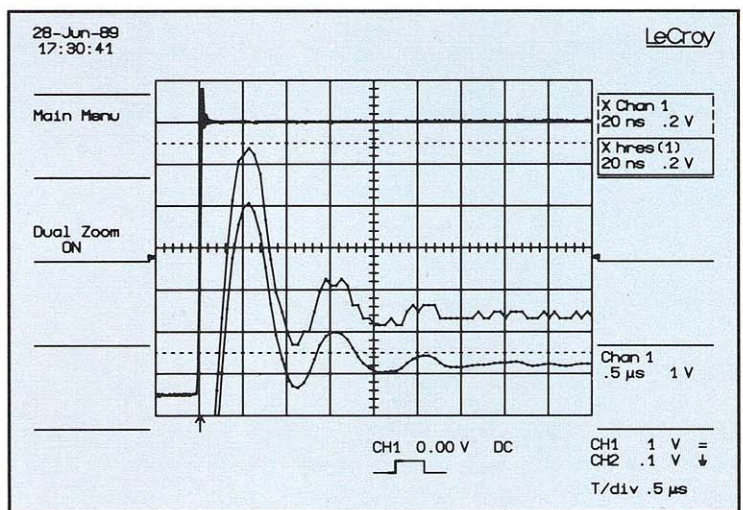

Figure 4: 1-bit enhancement of ringing on a step response.

**High Resolution on Random-Interleaved Sampled (RIS) Waveforms** - High Resolution can almost always be used on RIS waveforms without any loss of bandwidth because the RIS traces are usually highly oversampled with respect to the analog bandwidth of the oscilloscope. For example, at least one bit enhancement can always be used for RIS waveforms with a timebase of 1  $\mu$ s/div or faster. This is illustrated in Figure 5 where a 100 MHz signal is displayed with (top trace) and without (second trace) 1-bit High Resolution enhancement. The improvement can easily be seen on the 5 times vertically expanded traces shown below. In this case the -3 dB bandwidth of the digital High Resolution filter was 1 GHz, and thus it has no significant effect on the signal bandwidth of the instrument.



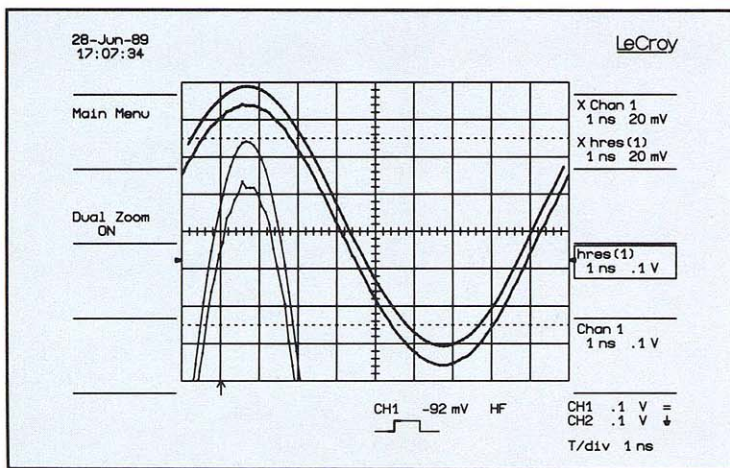

Figure 5: Improvement of the noise present in a RIS waveform when viewed with vertical expansion.

Conversely, RIS is very useful for increasing the sampling frequency of repetitive signals prior to High Resolution filtering even if RIS wouldn't be used for the normal trace. This is because the -3 dB bandwidth of the filter is increased by the increase in effective sampling frequency, and a more severe filter (greater enhancement) can be used for a similar loss of bandwidth. This is illustrated in Figure 6, which is the same as Figure 4 except that RIS was switched on, allowing the enhancement to be increased to 3 bits.

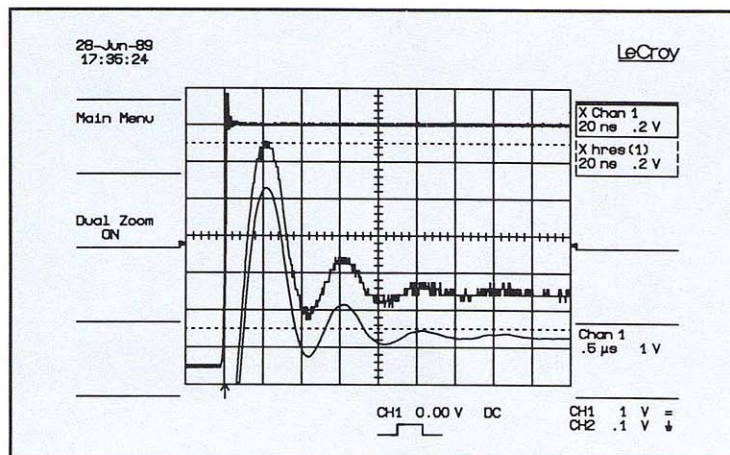

Figure 6: The same step response as in Fig. 4 except the use of RIS allows 3-bit enhancement without the loss of bandwidth.

**Signal Filtering with the High Resolution Function** - As the filters used for increasing the resolution are low pass filters, they can also be used as low pass signal filters in some situations. With careful choice of the filter bandwidth as a percentage of Nyquist frequency (via choice of the filter's resolution increase) and of the Nyquist frequency (via choice of the timebase), the filters can be used to remove or reduce the effects of high frequency interfering signals. The spectrum analysis function will be an invaluable aid to determining the relationship between the different component frequencies of the signal. Using, for example, FFT Power Density, this information can conveniently be seen directly in terms of the current Nyquist frequency, so the correct choice of filter becomes simple. The spectrum analysis can also be used after filtering to confirm the presence, or otherwise, of the various components of the original signal.

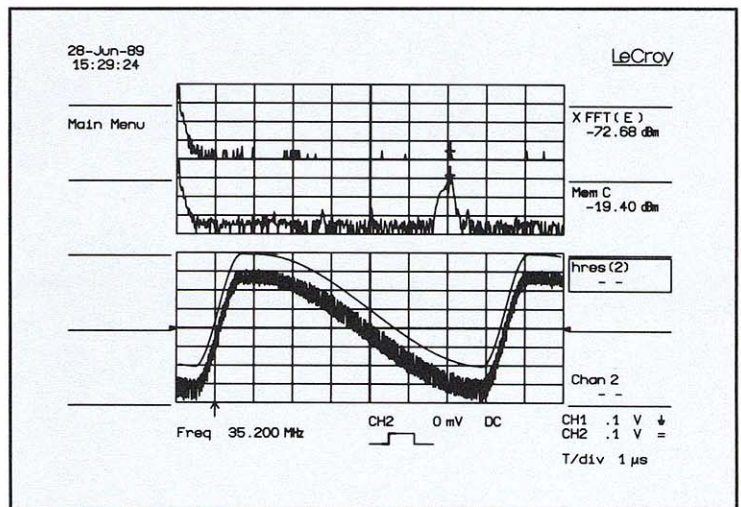

Figure 7: Illustration of the removal of coherent interference with the enhanced resolution filters.

Figure 7 shows the effect of High Resolution filtering on a low frequency signal which has high frequency interference. The lower grid shows two traces. The bottom one is the original trace, plagued with high frequency interference. The trace above is the same signal after the 2.5-bit enhancement High Resolution filter has removed the 35 MHz interference. The upper grid shows the Fourier Transform (with 5 times horizon-



tal expansion) of the signals in the lower grid, again with the filtered signal above. The -3 dB bandwidth of the filter in this case is 5.8 MHz, and the cursors show that the interfering signal has been attenuated by 53 dB. In this case averaging many traces would not have the desired effect of removing the interference because the interference is not random.

**Cautionary notes on the use of the High Resolution function** - The High Resolution function only improves the resolution of a trace, it cannot improve the accuracy or linearity of the original quantization by the 8-bit ADC.

The constraint of good temporal response for the High Resolution filters excludes the use of maximally-flat filters. Therefore, the passband will cause slight signal attenuation for signals near the cut-off frequency. One must be aware, therefore, when using these filters, that the highest frequencies passed may be slightly attenuated. The frequency response of a typical High Resolution filter (the 2-bit enhancement filter) is shown in Figure 8. The -3 dB cut-off frequency at 5.8% of the Nyquist frequency is marked.

The filtering must be performed on finite record lengths. Therefore, the discontinuities at the ends of the record cause data to be corrupted at these points. These data points are not displayed by the digital scopes and so the trace becomes slightly shorter after filtering. The number of samples lost is exactly equal to the length of the impulse response of the filter used, and thus varies between 2 and 117 samples. Because the scopes in focus here have very long waveform memories, this loss is not normally noticed (it is only 0.2% of a 50,000 point trace, at worst). However, it is possible to ask for filtering on a record so short that there would be no data output. The DSO's will not allow filtering in this case.

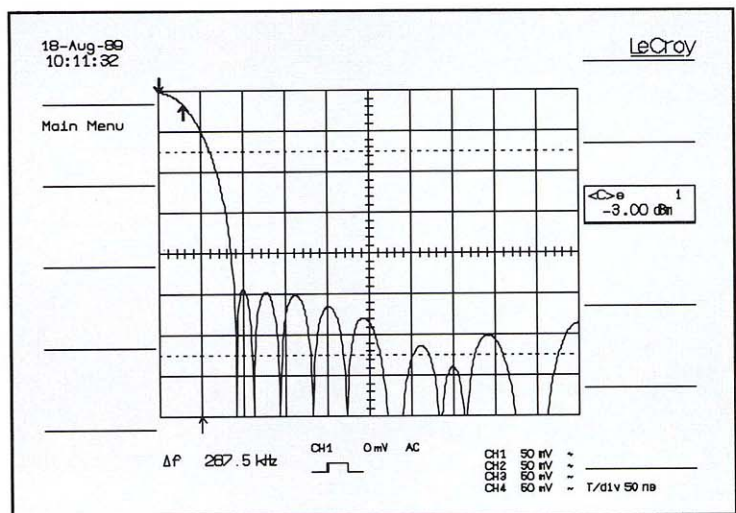

Figure 8: Frequency response of a typical enhanced resolution filter.



## How to Trigger on the Most Elusive Events

This tutorial reviews the trigger features of the LeCroy 9450, 9420, 9424 and 7200 Series Digital Oscilloscopes which make them elusive event finders. It should be of interest to all electronics engineers and researchers studying elusive phenomena.

After describing the importance of a powerful trigger in an oscilloscope, the article briefly describes each trigger feature and illustrates it with real examples ranging from microprocessor debugging to telecommunications, and from magnetic disc testing to power line monitoring.

### Introduction

The power of a digital oscilloscope in any given application depends on a combination of several features such as bandwidth, sampling rate, resolution and memory length.

An important criterion when choosing a digital oscilloscope is also the flexibility and sophistication of the trigger. To capture rare phenomena such as glitches or spikes, logic states or missing bits, the user needs a much more sophisticated trigger system than can be found in conventional oscilloscopes.

The implementation of the trigger system in recent LeCroy oscilloscopes will be discussed below and its usefulness in particular applications will be shown.

#### I. The Standard Trigger Mode

The standard mode resembles that of a conventional analog oscilloscope, and is directly controlled using the front-panel controls. The following controls and modes are available:

**Trigger source:** CHANNEL 1, CHANNEL 2, LINE, EXT, EXT/10

**Trigger coupling:** AC, LF Reject, HF Reject, DC, HF

**Trigger slope:** Positive, Negative

**Trigger level:**

Channel 1 and 2: adjustable to  $\pm 4$  divisions

**EXT:** adjustable to  $\pm 2$  V

**EXT/10:** adjustable to  $\pm 20$  V

**LINE:** Not adjustable

**Trigger mode:** Single event, Normal, Automatic, Sequence

The trigger delay can be adjusted between 1000 screen widths after the trigger, and one screen width before the trigger. Together with large memories (50 kilowords/channel), this enables the user to see events which occur much later or much earlier than the trigger itself.

A very distinctive feature of the LeCroy triggers is that coupling, slope and level can be adjusted separately for each trigger source (CH1, CH2 and EXT), allowing ultimate trigger flexibility.

Figure 1 shows a typical LeCroy scope display. The trigger level is indicated by the small arrows at the left and right edges of the grid, and the trigger timing position by the arrow under the lower grid. At the bottom of the screen, a trigger summary, including LeCroy's trigger graphics, gives an overview of the trigger conditions. Figure 2 shows the data acquisition menu which is available at the touch of a button. The trigger conditions, as well as the acquisition conditions, are fully specified here.

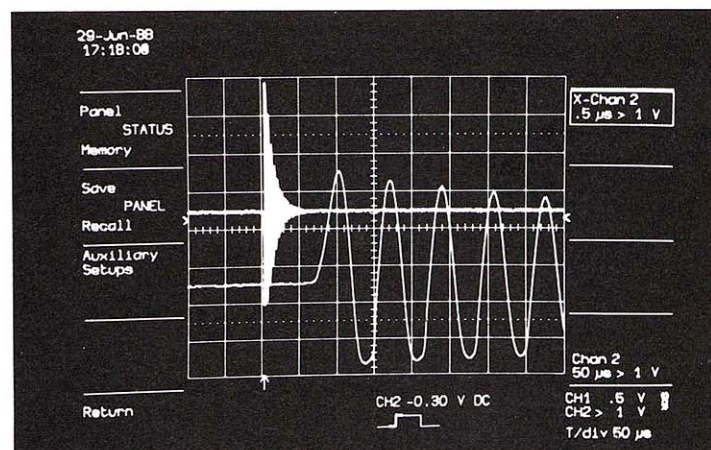

Figure 1: A typical 9450 display. The upper trace is the original signal acquired on channel 1. The lower trace shows a 10X expansion of the same trace.



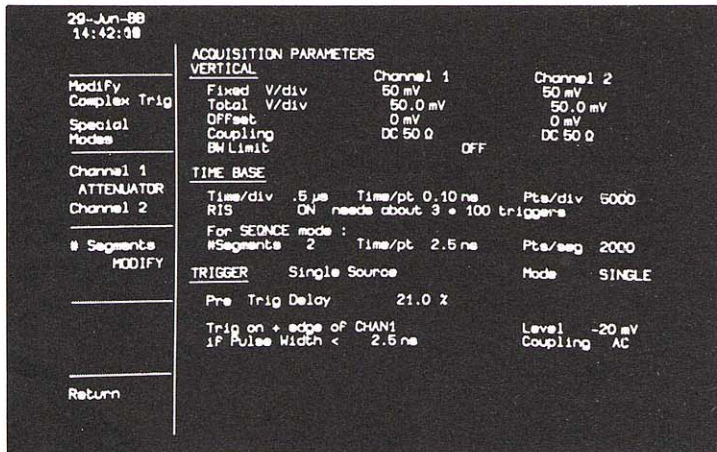

Figure 2: The acquisition parameter menu of the 9450 shows a summary of both the data acquisition and trigger conditions.

Another important feature of the LeCroy triggers is Sequence Mode (Figure 3), which divides the long 50 kiloword acquisition memories into as many as 200 segments. The instrument can then acquire as many events as the defined number of segments, and record each new event in successive segments.

The benefit of this trigger mode is that the dead time between successive events can be as short as 100 μsec. Therefore, the acquisition of multiple events is very rapid. On the other hand, data acquisition takes place only in time intervals where interesting phenomena occur and uninteresting time intervals are ignored. This feature is further enhanced by the complex trigger which selects only the events which satisfy the trigger conditions even when they are part of a burst of events. Real-time clock information associated with the first trigger is provided as well as time stamps for any successive triggers (Figure 4).

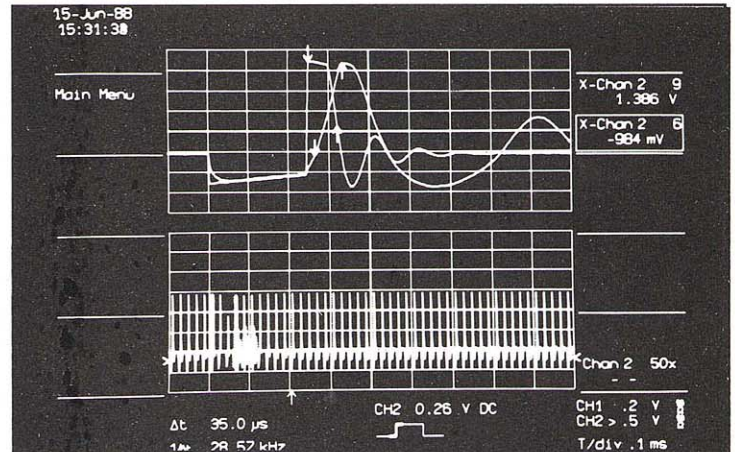

Figure 3: The 50K memories can be segmented into as many as 200 partitions. Power switching events are logged over 50 segments (bottom). Dual zoom expansion (top) allows accurate comparison of events 6 and 9.

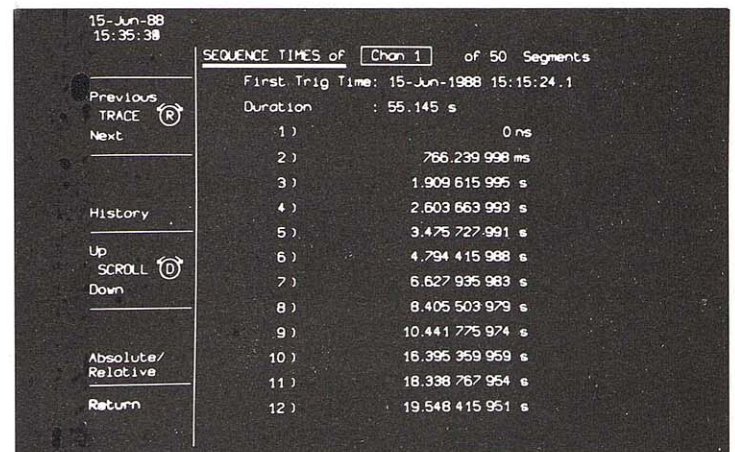

Figure 4: Sequence trigger mode. The display shows the real-time clock value corresponding to the first event in the sequence and the arrival time of each successive trigger relative to the first one. Time is indicated with 1 nsec resolution.



## II. The Complex Trigger

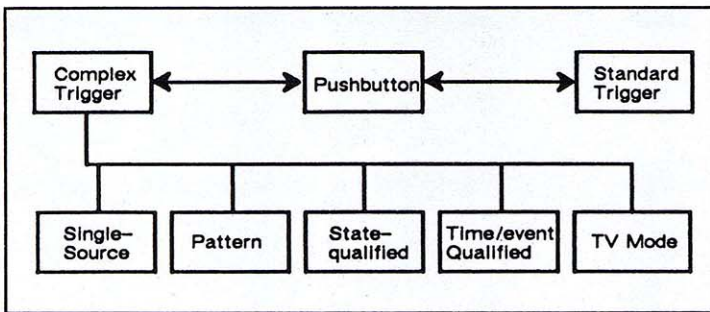

Figure 5: The complex trigger menu

A push-button control switches between standard and complex trigger. With the complex trigger the user has access to a variety of sophisticated trigger modes (Figure 5) based on two important facilities.

- a. The ability to preset the logic state of the three trigger sources, CH1, CH2 and EXT.
- b. A presettable counter, which can be used to count a number of events between 1 and  $10^9$  or to measure time intervals from 2.5 nsec up to 20 sec in steps of 1% of the time scale (minimum step 2.5 nsec).

Combining these two facilities opens the door to such a large variety of trigger conditions that the oscilloscope could potentially become cumbersome and difficult to use. However, great care has been taken to make the complex trigger mode user-friendly without loss of versatility. On the screen, special trigger graphics illustrate the trigger conditions for every trigger mode. Examples of these graphics can be found below the grid in all the screen figures.

The complex trigger has five principal modes of operation:

- single source trigger,
- pattern trigger,
- state qualified trigger,
- time/event qualified trigger,
- TV trigger

Each category is described in the following sections together with relevant application examples.

### a. Single source trigger

Using this trigger mode, the user can select the desired source and its coupling, level and slope. A hold-off can be set when the waveform contains bursts or patterns and can be specified as a hold-off by time or number of events.

Alternatively, a width value can be selected. **The width-based trigger is a major innovation in oscilloscopes.** Two possibilities exist:

- a. Pulse Width (i.e. the time from the trigger source transition of a given slope to the next transition of opposite slope).
- b. Interval Width (i.e. the time from the trigger source transition of a given slope to the next transition of the same slope).

After selecting a pulse or an interval width, the user can choose to trigger on widths smaller or greater than the given value. This feature offers a wide range of capabilities for application fields as diverse as digital and analog electronic development, ATE, EMI, telecommunications, and magnetic media studies. Catching elusive glitches becomes very easy. In digital electronics, where the circuit under test normally uses an internal clock, a glitch can be theoretically defined as any pulse narrower than the clock period (or half period). The oscilloscope can selectively trigger only on those events, as shown in Figure 6.



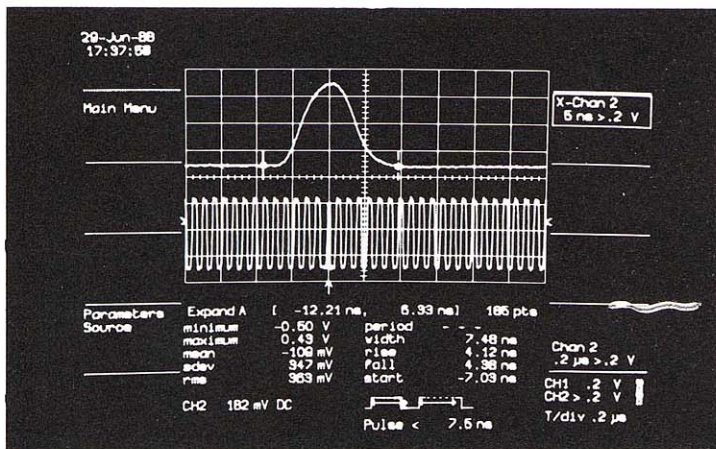

Figure 6: Selective trigger on a glitch. The 9450 has been set to trigger on any pulse narrower than 7.5 nsec. The lower trace shows a long train of rectangular pulses of which the trigger system has identified one which satisfies the width condition. The magnified upper trace shows a glitch 7.48 nsec wide. Pulse parameters are used to characterize this phenomenon after expansion.

In a broader sense, a glitch can be defined as a pulse much faster than the waveform under observation. As glitches are a source of problems in many applications, the possibility of triggering on a glitch, investigating what generated it and measuring the damage caused by it, represents a fundamental research tool.

The LeCroy scopes' long memories (50 kilowords/channel) allow the user to examine signal data both before and after the trigger. Furthermore, high sampling rates (400 megasamples/sec for the 9450, 100 megasamples/sec for the 9420) in combination with a horizontal expansion capability enable waveforms to be expanded up to 1000 times.

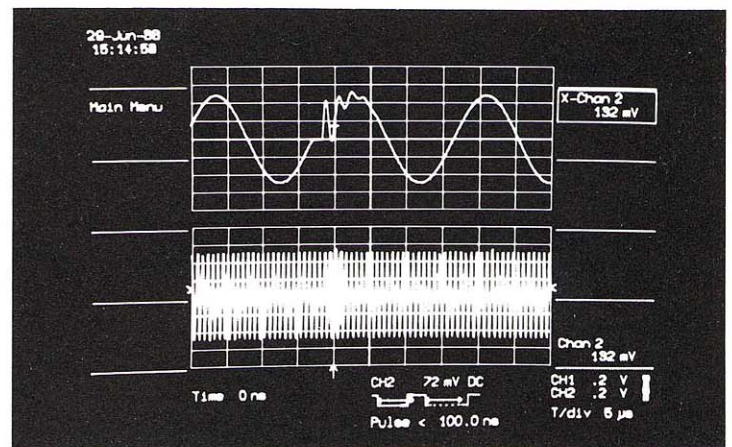

Figure 7: A sine wave was monitored for transients. The insertion of a load generates a perturbation sufficient to activate the FASTGLITCH trigger mode (lower trace). The upper trace is a 50 X horizontal magnification showing details of the transient.

The trigger on pulse widths smaller than a given value has been named FASTGLITCH. Like all the other trigger modes, FASTGLITCH trigger mode can be selected at any time-base setting. The user can define widths with 2.5 nsec resolution starting at a minimum value of 2.5 nsec.

For recurrent glitches, the oscilloscope's random interleaved sampling mode allows glitch visualization with an equivalent sampling rate of up to 10 gigasamples/sec, that is one sample point every 100 psec.

Figure 7 shows a transient on a sine wave being captured using the FASTGLITCH trigger mode. Figures 8 and 9 demonstrate how the interval width trigger is used to detect a phase change in an analog modem (interval width <) and a missing bit in a magnetic disk read/write operation (interval width >).



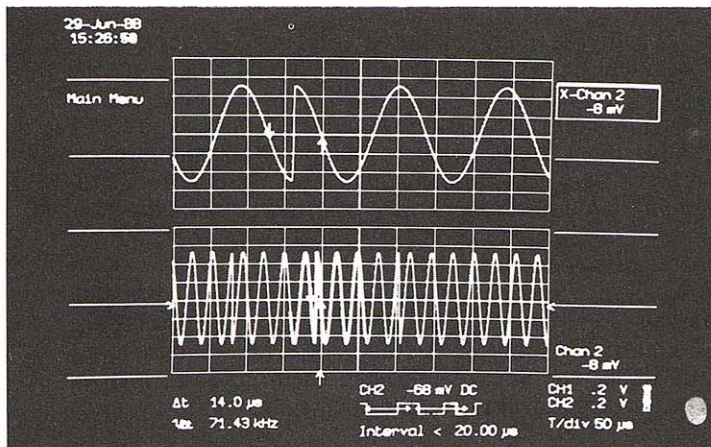

Figure 8: Phase changes in a signal transmitted by an analog modem. The trigger configuration was based on the assumption that a phase change would correspond either to a pulse width smaller than half the period of the sine wave, or to a time separation between pulses shorter than the period of the sine wave.

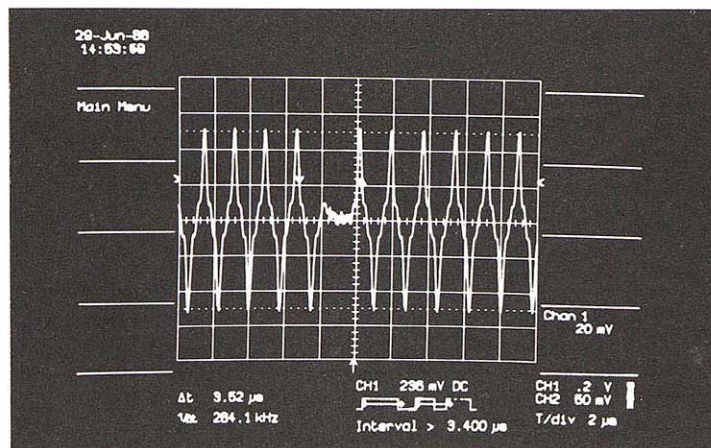

Figure 9: Triggering on a missing bit when reading a magnetic disc. A missing bit can be interpreted as a pulse wider than the period of the pulses. The same trigger could have been obtained by setting a pulse separation greater than the pulse period.

## b. Pattern trigger

The pattern trigger is based on the logic state of the three input channels, CH1, CH2 and EXT. Here the user can set the coupling and trigger level of each channel. He then chooses the required logic state for each input and decides

whether the scope should trigger at the beginning of the defined pattern or at the end, i.e. when the pattern is “entered” or “exited”.

The FASTGLITCH and time-separation trigger capabilities described above can be combined with pattern trigger, enabling the user to compare the duration of the pattern, or the interval between patterns, with a reference time.

This type of trigger will be greatly appreciated whenever complex logic has to be tested. Examples are: computer or microprocessor debugging; high energy physics where a physical event is identified by several events occurring simultaneously; and debugging of data transmission buses in telecommunications. Figure 10 shows an example of pattern trigger with no constraints apart from the occurrence of the required logic combination.

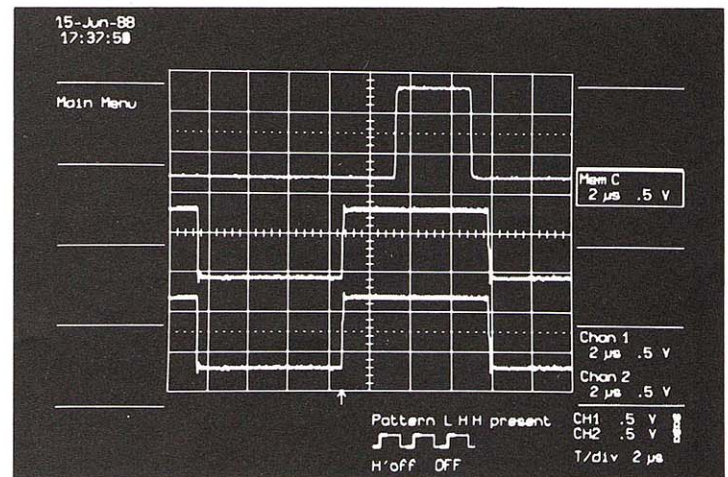

Figure 10: Example of a logic state trigger. As shown in the trigger graphics under the display, the 9450 is set to trigger on CH1 low, CH2 high and EXT high, as soon as the pattern is valid, i.e., at the beginning of the pattern.

The 9450 pattern trigger is the logic AND of the three defined input logic states. However, applying de Morgan's laws, the pattern trigger becomes much more general. To demonstrate this, let's look at an example which is of particular importance, that is a bi-level trigger (see Figure 11). Bi-level trigger means that the user wants the scope to trigger on a single-shot signal of unknown polarity and of roughly known amplitude.



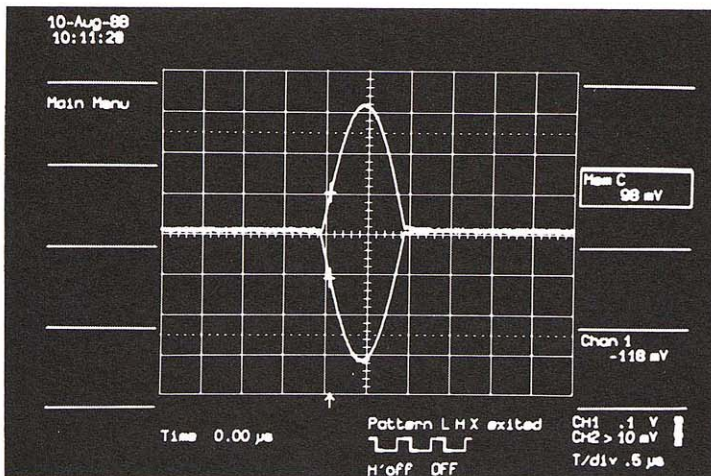

Figure 11: Example of bi-level trigger. The pattern trigger is set so that the scope can trigger on both the upper as well as the lower trace. While the lower trace shows channel 1, the upper trace shows a previous event stored in memory C. The cross-hair markers show the trigger point in both cases.

This can be done by connecting the signal source to two inputs, for instance CH1 and CH2. Let's imagine setting the threshold of CH1 to +100 mV and the threshold of CH2 to -100 mV. Bi-level triggering occurs if the scope triggers on CH1 for any pulse greater than +100 mV OR on CH2 for any pulse more negative than -100 mV.

In Boolean notation we can write:

$$\text{Trigger} = \text{CH1} + \overline{\text{CH2}} \text{ (when entering the pattern).}$$

By deMorgan's law this is equivalent to:

$$\text{Trigger} = \overline{\overline{\text{CH1}} \cdot \overline{\text{CH2}}}$$

i.e., trigger on CH1 = low AND CH2 = high when exiting the pattern. This last configuration can be easily programmed.

The possibility of setting the threshold individually for each channel extends this method to a more general window trigger. In this case, to trigger the 9450/20 the input pulse amplitude must lie within or outside a given window.

Another important aspect of the pattern trigger is that all the features of the single-source trigger mode can also be applied. That is, the user again has the choice of imposing a hold-off by time or by number of events, or alternatively, of detecting durations or intervals which are greater or smaller than a time fixed by the user.

A warning should be given here about which time interval is compared to the reference time. The pattern trigger is designed to let the user always choose the trigger point. So if, for instance, LHX-entering is chosen, the trigger will occur as soon as the pattern LHX becomes true. If we now add the condition pattern width < reference time, the width which is compared to the reference time is the width of the pattern  $\overline{\text{LHX}}$  complement preceding the trigger point. Therefore this trigger mode checks the repetition time of the pattern.

On the contrary, if LHX-exiting, pattern width < reference time is chosen, then the duration of the LHX state will be compared to the reference time and the scope will trigger when LHX becomes false (see Figures 12 and 13).

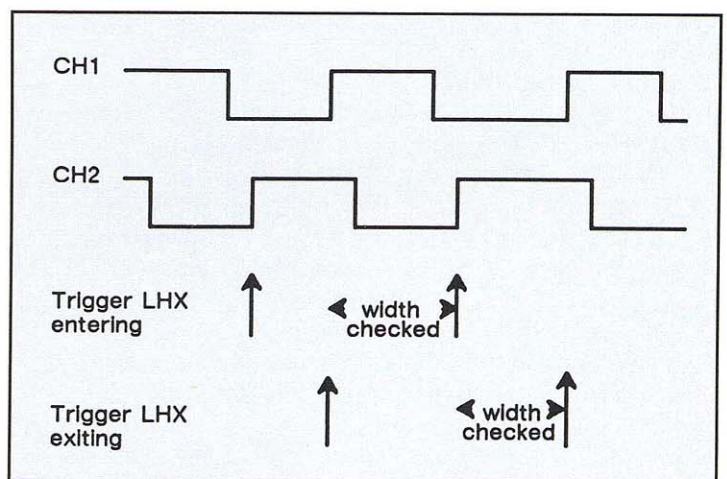

Figure 12: Timing diagram of the pattern trigger.



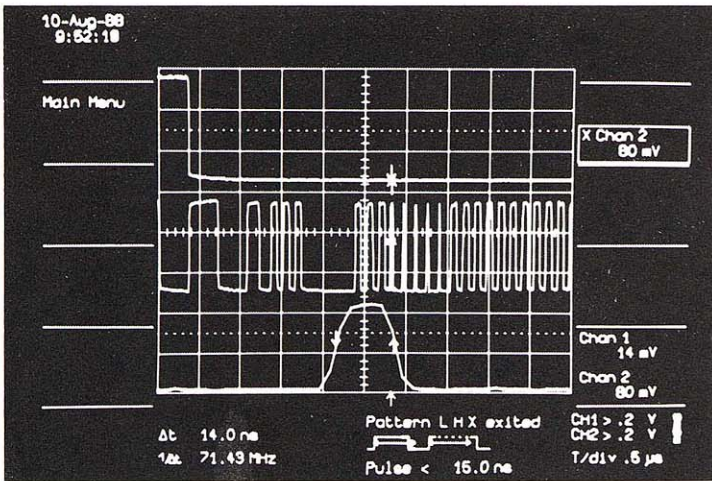

Figure 13: Example of triggering when exiting a pattern defined as LHX. The upper trace is CH1 and the middle trace is CH2. The trigger time is indicated by the arrow below the grid. The further constraint of a pulse width smaller than 15 nsec has been added. The width of the LHX pattern is compared to the specified pulse width of 15 nsec. The lower trace shows an expansion of CH2 with the time cursors showing the pulse width which has caused the trigger.

### c. State-qualified trigger

This trigger enables the oscilloscope to trigger on one source, CH1, CH2 or EXT, as soon as a selected logic condition of the other two sources exists. The user sets the required logic pattern on two sources and uses this condition as an enable or a disable for the third source. Different coupling, slope and trigger level settings can be chosen for each channel.

It is also possible to choose a delay by time or number of events which starts as soon as the logic pattern is valid, as illustrated in the timing diagram, Figure 14.

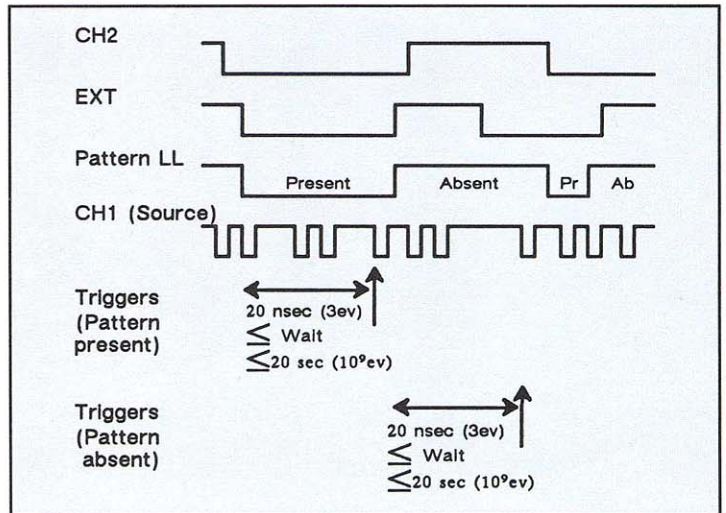

Figure 14: Timing diagram of the state-qualified trigger.

Typical applications for this trigger can be found wherever time violations occur, for instance in microprocessor debugging (Figure 15) or in telecommunications.

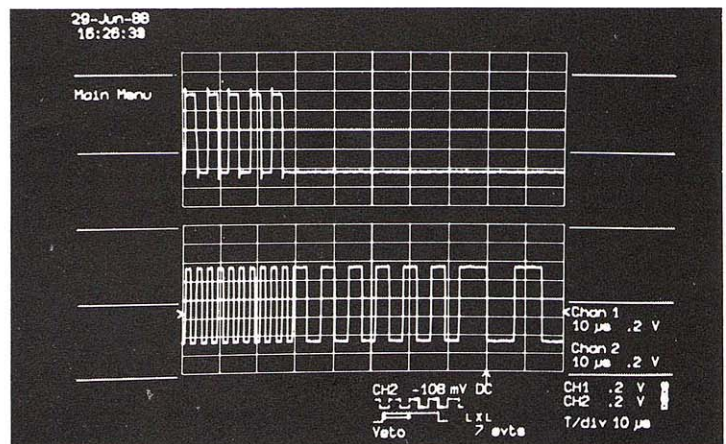

Figure 15: Example of state-qualified trigger taken from a microprocessor cycle. When the transition occurs on CH1 and EXT (upper trace, EXT being identical to CH1), a delay of 7 events starts on channel 2 (lower trace). The next high to low transition on CH2 triggers the scope provided CH1 is still in a low state.



## d. Time/event qualified trigger

This is another conditional trigger requiring a trigger source, CH1, CH2 or EXT, and a given logic state to exist on the three inputs. From the moment that this logic state is present or absent, a delay can be defined in terms of time or number of events. When the delay has elapsed, triggering is enabled as shown in Figure 16. This feature provides a solution to applications which involve systems with long firing jitter time, e.g. lasers and magnetic discs.

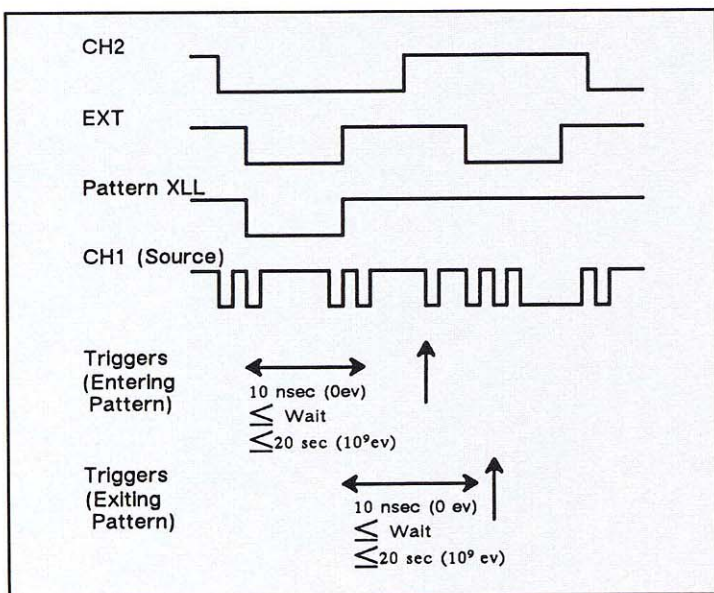

Figure 16: Timing diagram of the time/event qualified trigger.

Other applications can be found in telecommunications or microprocessors for debugging of asynchronous data buses. An example is shown in Figure 17.

## e. TV trigger

The user can decide whether he wants to trigger on every field, on either odd or even fields, or, when working with color TV signals, he can trigger on one of the four or eight color fields. This can be done for most of the TV standards such as NTSC, PAL-M, PAL and SECAM-625.

Once the field has been selected, the user can selectively trigger on any line within the field.

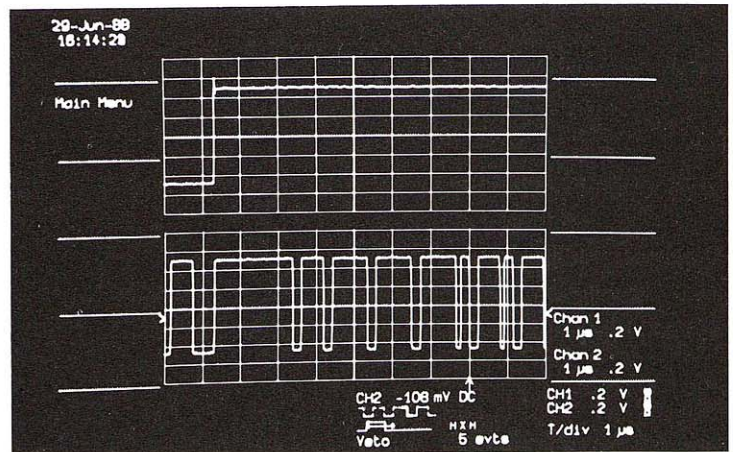

Figure 17: Example of time/event qualified trigger also taken from a microprocessor cycle. When the transition occurs on CH1 (upper trace), a delay of 5 events starts on CH2; the sixth event triggers the data acquisition.

When it comes to TV applications the LeCroy digital oscilloscopes offer many advantages over traditional test equipment. By combining pre- and post-trigger viewing capabilities, long 50 kiloword acquisition memories and very high sampling rates, the oscilloscopes enable measurements with improved timing accuracy and provide better analytical capabilities. For example, waveforms are easily stored and overlaid allowing rapid comparisons for measurements such as K ratings. Expansion (up to 1000 times) can be used to reveal glitches and discontinuities that affect picture quality and stability. Timing measurements on sync width, burst width, front-porch and horizontal blanking width can all be made with greater precision even on single-shot acquisitions. And, an optional FFT (Fast Fourier Transform) Spectral Analysis package is available so that frequency, power and phase information can be revealed at the touch of a button.

## III. Conclusion

The LeCroy 9450, 9420, 9424 and 7200 series offer the most comprehensive trigger systems available in an oscilloscope. Versatility has been combined with user friendliness to provide instruments with exceptionally powerful triggers.



# Fundamentals of Analog to Digital Conversion

The heart of any DSO or modular digitizer is its analog to digital converter. The function of this device is to output a binary logic code ("digital" word) representing the analog voltage applied to its input. The fundamental measures of ADC performance are the resolution achieved and the speed of conversion.

Resolution is normally expressed as the number of bits defining the output code. The converter's speed is normally expressed as the number of conversions/second that can be accomplished in steady operation; that is the maximum sample rate.

As a matter of practicality, the performance of a digitizer system is strongly influenced by performance of the elements supporting the ADC, including the analog signal conditioning, the sample/hold, the time base, the trigger circuit and the buffer memory. In general, all of these elements can act to restrict the resolution and speed offered by the ADC.

Analog to digital conversion may be achieved by any of several techniques. Each method offers specific advantages as well as drawbacks. LeCroy employs different ADC techniques in its various products, based upon the application requirements. Several of these are reviewed here.

## THE FLASH CONVERTER

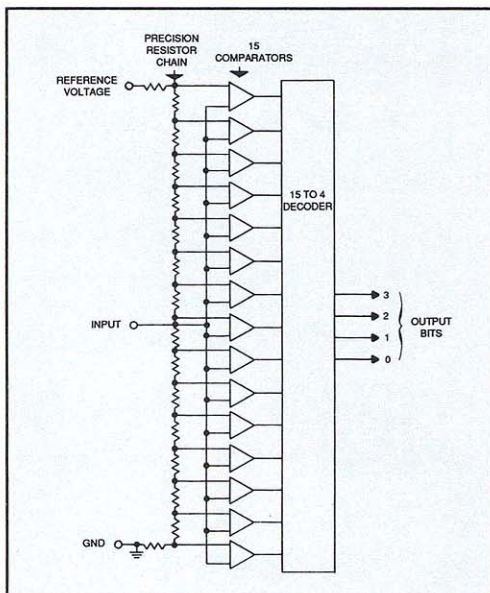

Figure 1.

The "Flash" converter illustrated in Fig. 1 offers an attractive means of A/D conversion at high speed. The method is functionally simple but hardware intensive. It is sufficiently rapid to be the only method applied to video bandwidth signals. Current silicon fabrication technology allows production of 8 bit flash converters running at 300 megasample/sec.

An "n bit" converter is formed from  $2^n - 1$  comparators, all sensing the input signal. Each of these comparators has a different reference input, these being derived from a voltage dividing precision resistor string of  $2^n$  equal elements. The outputs of all the comparators are melded by combinatorial logic to yield the output code.

The flash converter provides very rapid conversion at sample rates appropriate for a DSO or general purpose modular digitizer. LeCroy utilizes flash technology in several of its DSOs and modular digitizers.

## THE DUAL-RANK FLASH CONVERTER

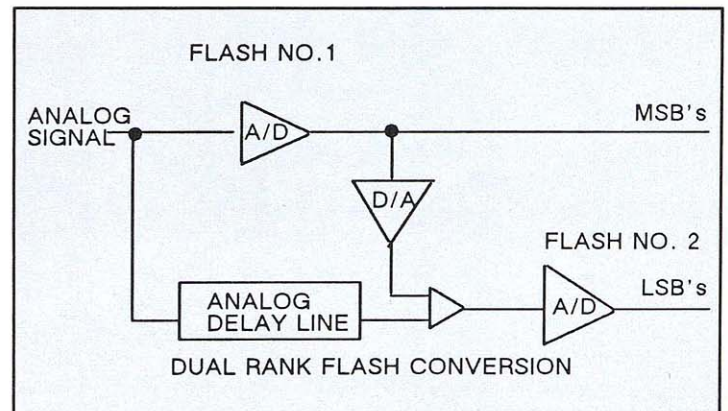

Figure 2.



Figure 2 illustrates a “dual-rank flash converter”, sometimes termed a “sub-ranging” ADC. This type of converter uses two flash ADCs, each of lower resolution than the required output code length. In simplest (“dead reckoning”) implementation, each of these provides half of the bits in the output word. The first flash in such a ‘dead reckoning’ converter needs the same precision as the final composite, i.e., 4 bits & 4 bits only works if the first 4 bits has 8 bits of precision. More advanced (“over-lapped”) implementations utilize two converters with combined total bit length *greater* than the number of bits required in the output code.

The two flash converters work in consort. Converter #1 digitizes the incoming analog signal, directly. Its output code represents the most significant bits of the total code. This “most significant nibble” (MSN) drives a rapid digital-to-analog converter. The DAC’s analog output is subtracted from the analog signal and gain is applied to this remainder. The remainder is digitized by converter #2 and its output code represents the “least significant nibble” (LSN).

An analog delay line is employed to allow both converters to work simultaneously. Hence, converter #1 processes the MSN of the *n*th sample while converter #2 digitizes the LSN of the sample *n-1*.

Dual-rank flash conversion provides the balance of speed and resolution required for a flexible digitizer. Conversion rates of 200 megasample/sec at 8 bits precision have been achieved with this technology. LeCroy utilizes overlapped dual-rank converters in some of its modular digitizers.

### THE INTERLEAVED CONVERTER

Multiple flash converters can also be arranged in the “interleaved” fashion of Figure 3. LeCroy employs this configuration in its 8-bit, 1 gigasample/sec DSOs.

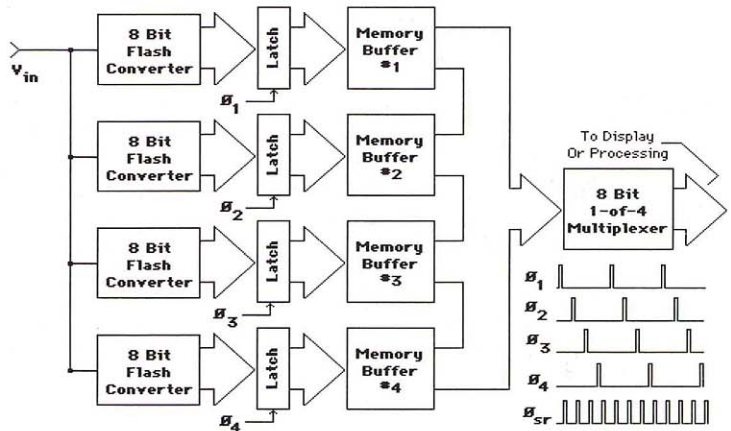

Figure 3.

Each of the four flash converters runs at 250 megasample/sec. The strobing clocks for these converters are arranged in phase quadrature, so that the converters are interrogated in sequence.

Each of the converters has its own buffer memory, updated at the 250 megasample/sec acquisition rate of the converter. The data is read from these buffers in interleaved fashion for display or processing by a commutating multiplexer. When the samples are accessed in this fashion, a single time history sampled at 1 gigasample/sec results.



## THE SIGMA-DELTA CONVERTER

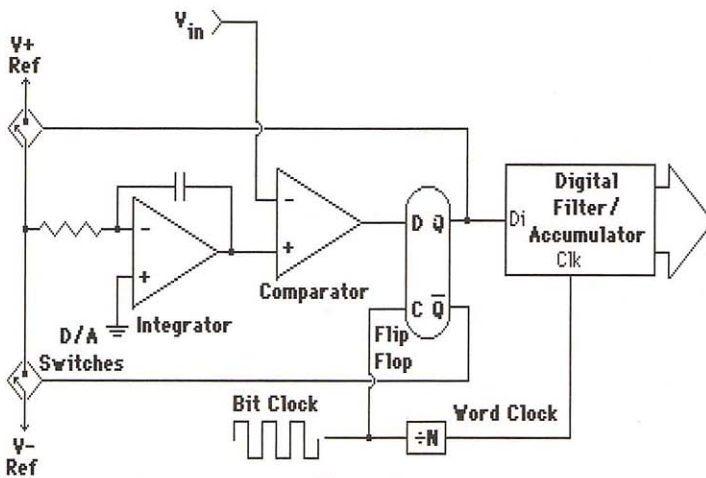

Figure 4.

Recent efforts in the high resolution, medium speed area have been directed toward the "Sigma/Delta Modulation" converter, illustrated in Figure 4. These devices can currently provide resolution to 16 bits at 100 kHz sample rate or to 12 bits precision at 400 kHz. They are particularly attractive for use with commercially distributed digital signal processing (DSP) ICs, for which their serial output format is appropriate.

An integrator, comparator and clocked flip-flop define a "delta modulator" loop. This circuit functions as a 1 bit ADC tracking the derivative of the input signal.

The integrator is constantly ramped up or down from its current output value. The ramp magnitude ( $dV/dt$ ) is constant, while its sign (+ or -) is determined by the flip-flop. The flip-flop gates the comparator's state to the ramp controlling D/A switches at the bit clock or *input* sample rate. This causes the integrator's output to track the input signal, although it "buzzes" about this value with a "triangle wave" error at the bit clock rate.

The serial bit stream emanating from the flip-flop thus represents a 1 bit quantized image of the input's derivative. This bit

stream is subjected to low-pass digital filtering, accumulation (the "sigma" process) and decimation (64:1 typical). The accumulator's output is a series of digital words available at the decimated *output* sample rate. Each of these represents the signal's mean value during the accumulation period and reflects many samples at the *input* rate.

The output data is equivalent to a parallel code developed at the *output* sample rate. Current embodiments output this data as a serial bit stream accompanied by an output bit clock and start-of-word framing pulse. These converters fall short of the speed requirements for a general purpose DSO.

## THE WILKINSON CONVERTER

One of the earliest ADC realizations is the Wilkinson converter shown in Figure 5. This embodiment is also variously known as a "dual slope", "run-down" or "integrating" ADC.

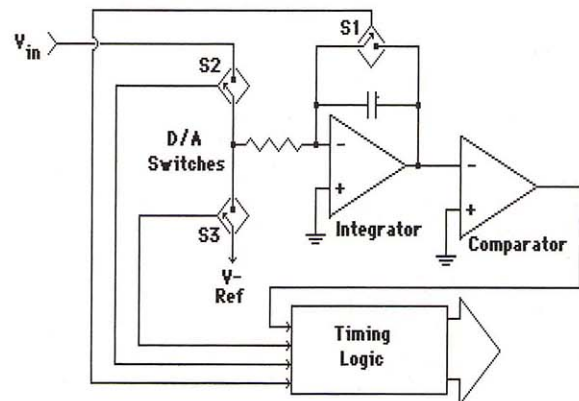

Step	S1	S2	S3	ACTION
1	closed	closed	open	Zero Integrator
2	open	closed	open	Charge capacitor from Vin for T1
3	open	open	closed	Discharge capacitor from Vref until comparator senses zero at T2

Figure 5.



Prior to each conversion, the integrator's capacitor is "zeroed" by closing S1. This switch is then opened and the input signal is integrated for a fixed period of time, T1. During T1, the integrator's output ramps linearly, with a slope proportional to the input's magnitude. The input is then removed (S2 opened) and a reference signal of opposite polarity is applied (S3 closed). A timer is started at this transition and stopped when the comparator monitoring the integrator detects a return to zero output. The timer's count (T2) is output as the ADC code.

Several variations on this type of converter have been developed to improve performance. These include the use of two reference polarities and logic to determine input polarity ("sign-magnitude"), use of two additional time periods to detect and correct for component bias error ("quad-slope"), substitution of constant current reference sources, and the use of current pulses of controlled duration ("pulse modulation").

These converters can be very resolute and precise. T1 can be selected to integrate power-line frequency noise to zero, improving S/N. Typical digitizing speed is too slow for DSO applications and thus the technique is generally used to analyze low rate events rather than for "sampling" purposes. Some of LeCroy's early nuclear research products still employ this technique..

## THE SUCCESSIVE APPROXIMATION CONVERTER

The "Successive Approximation" converter illustrated in Figure 6 is a very popular approach to analog to digital conversion. Here, a digital-to-analog (DAC) converter is used as a feedback element. The signal to be converted is applied as one input to a voltage comparator; the DAC provides the comparator's second input. Logic adjusts the code applied to the DAC to match these two levels. When the match is achieved, the DAC code is strobed to the converter's output latch.

The converter is termed "successive approximation" because the DAC code is adjusted one bit at a time, starting with the most significant bit (MSB). The DAC code is held in a "successive approximation register" (SAR) whose contents are changed by timing logic guided by the comparator's output. Thus an "N bit" ADC requires (at least) N "clocks" per conversion, rendering more resolute converters slower.

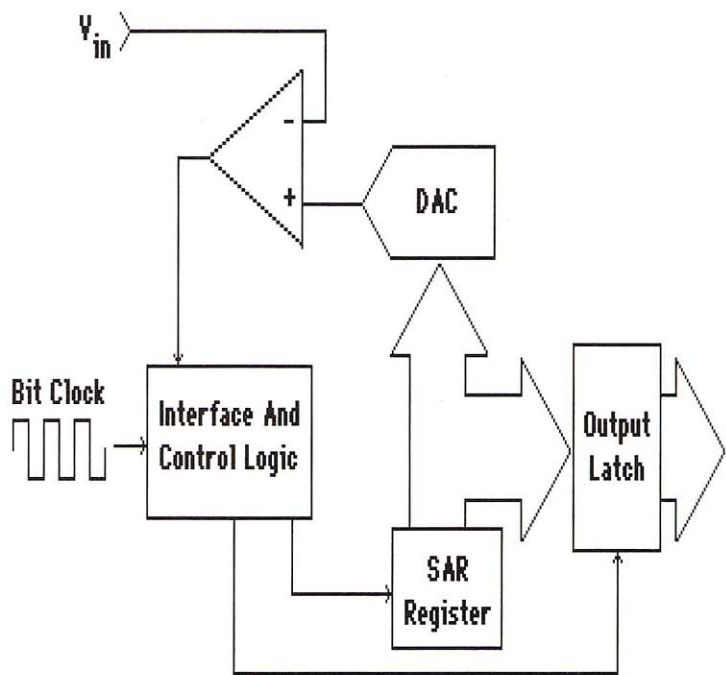

Figure 6.

At the start of conversion, the MSB is set high (1) and the remaining bits set low (0). If the comparator indicates the DAC's output to be less than the applied input, the MSB is retained high; otherwise it is reset to 0.

The test then proceeds to the next most significant bit, which is conditionally set to 1. The comparator's output is examined, again. If the DAC's output remains less than the input voltage, this bit is retained high in the SAR. If not, the bit is reset to 0. This process is repeated for all bits in sequence.

Successive approximation converters are popular in audio frequency instruments; they fall short of DSO speed requirements. Typical 1989 resolution/sample rate performance include: 8 bits @ 1 megasample/sec, 12 bits @ 300 kilosample/sec, 16 bits @ 16.7 kilosample/sec. This type of ADC is used in early LeCroy modular spectroscopy products.



## Fundamentals of Aliasing

Whenever a dynamic signal is synchronously sampled, a possibility of misunderstanding its frequency content exists. This difficulty is termed "aliasing", indicating that a given frequency may be misidentified. While aliasing is a time domain phenomenon, it normally presents only modest interpretive difficulty in this domain. When sampled data is transformed to the frequency domain, aliasing can seriously confuse the resulting spectrum.

We have all observed the aliasing phenomenon optically. Any child recalls seeing wheels revolving in the wrong direction as Indians chased a stagecoach across the screen of the local movie house. The error was caused by the camera's frame rate aliasing the frequency of spoke passage.

Most of us have tuned an automobile's ignition phase at least once. The "timing light" employed flashed at the firing or camshaft frequency, which is half of the crankshaft speed. When illuminated by this light, the rotating "timing mark" appeared frozen. In fact, the cam shaft frequency and all of its harmonics were aliased to DC by the periodic sampling light pulses. A similar action occurs when a signal is converted by an ADC.

### THE FUNDAMENTAL MECHANISM

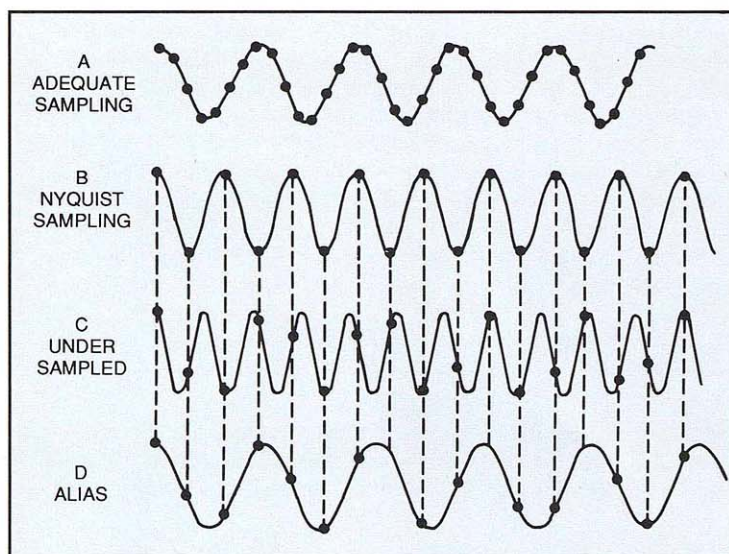

Consider what happens when we sample a sine wave, as shown in the preceding figure. If we have many samples per cycle, there is no difficulty in reconstructing the wave from the samples as in **A**. If we were to sample the signal at a sample rate equal to the sine's frequency, each sample would be identical and we would erroneously conclude the signal to be a DC level. For sample rates less than twice the sine's frequency we would consistently reconstruct a sinewave of erroneously low frequency as shown in **C** and **D**.

When we sample at twice the sine's frequency (**B**), we recover the frequency correctly. Note, however, that the recovered amplitude is a function of the sample phasing and we might recover any answer between zero and the actual amplitude. When a sinewave is applied to a sampled system at a frequency equal to half of the sample rate, it is said to be at the *Nyquist frequency* and is just at the "ragged edge" of information recovery.

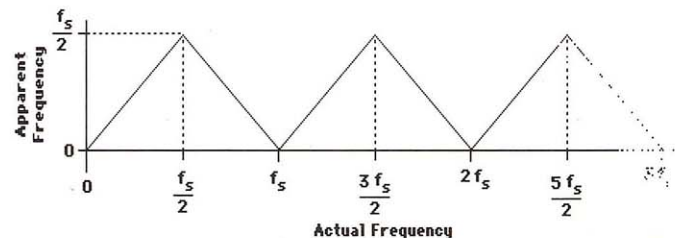

The above figure illustrates a fundamental property of sampled systems. If a digitizer operates at a sample rate,  $f_s$ , it is only possible to recover information about inputs at a frequency  $f_s/2$  or less. Inputs of higher frequency will "fold" or alias to appear as a frequency between DC and  $f_s/2$ . This effect is sometimes termed a "Faltung Convolution".

### ANOTHER POINT OF VIEW ... THE FREQUENCY DOMAIN

This effect can be better appreciated from a frequency domain viewpoint. Consider the following figure which illustrates the spectrum of an analog signal and the spectrum of sampled images of the signal at two different sample rates.



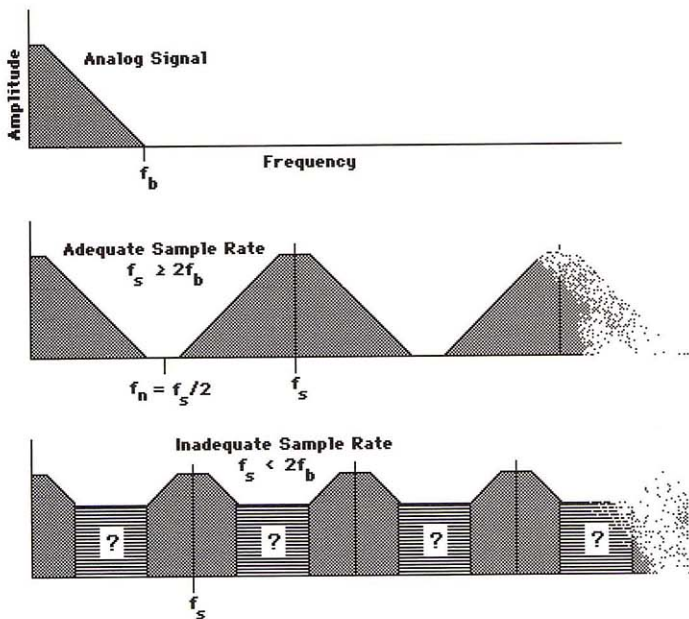

The sampling process introduces spectral images and reflections of the signal's content symmetrically distributed about the sample rate and all of its harmonics. When the signal's bandwidth,  $f_b$  is less than Nyquist frequency,  $f_s/2$ , these sampling-induced artifactual harmonics are distinct from the information-bearing spectrum sought.

When the signal's bandwidth exceeds  $f_s/2$ , the sample rate is inadequate and the sample-induced harmonics "overlap" the spectrum of the signal. This makes it impossible to discriminate between actual signal activity at a given frequency and "aliased" activity that actually occurred at a higher frequency.

In a practical sense, this is rarely a problem when viewing time domain waveforms; it can be a major problem when displaying spectra. In most instances, the instrument's sample rate can merely be increased to circumvent the ambiguity. In those circumstances where this is impractical, the signal must be bandlimited by use of an "anti-aliasing" filter.

### AN ANALOG SOLUTION TO A DIGITAL PROBLEM

An anti-aliasing filter is merely a low-pass filter used to limit the bandwidth of a signal so that it may be sampled at a desired rate. They are invariably incorporated in FFT analyzers and rarely implemented in DSOs.

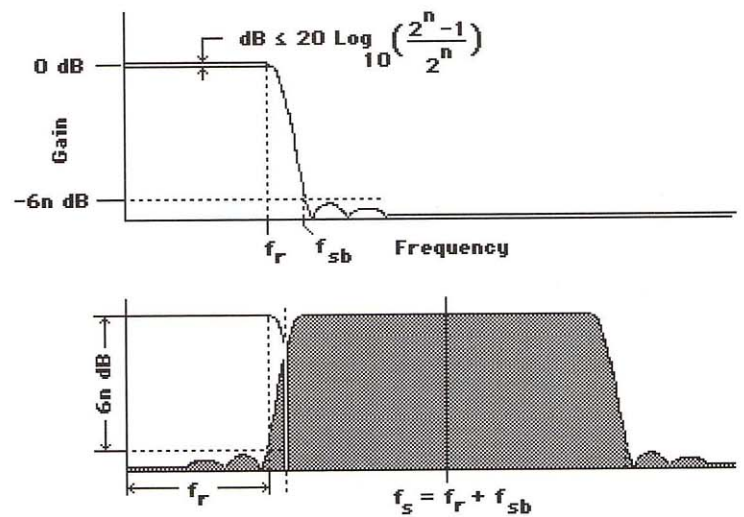

For reasons of computational efficiency, it is normally desirable to employ a filter with a very steep-sloped transition band. That is, a "brick wall" characteristic is desired. Elliptic (Cauer) filters are normally chosen for this role because of their exceedingly rapid initial attenuation by frequency. The above figure illustrates such a filter and its design requirements for a specific digitizing mission.

Elliptic filters exhibit many deficiencies including non-linear phase slope (non-constant group delay), pass-band ripple and non-monotonic stopband character. All of these characteristics are deleterious, particularly if sampled data is to be processed in the time or probability domains. They represent an optimum solution, solely, for spectral processing.

Presume that a frequency range of  $f_r$  needs to be studied with an  $n$  bit digitizer. The filter's unity gain passband needs to be flat between DC and  $f_r$ . "Flat" is defined as exhibiting passband ripple of 1 LSB or less. The filter must then "roll off" rapidly to a level of  $-6n$  dB or better. Depending on the number of poles and zeros and the specific "recipe" of the filter, this will be accomplished at some "stopband threshold" frequency,  $f_{sb}$ .

Arranging the sample rate,  $f_s$ , to be numerically equal to the sum of  $f_r$  and  $f_{sb}$  provides optimum placement of the filter, as shown. The lower figure illustrates the aliased image of the filter and demonstrates that this sample-rate/bandwidth placement protects the DC to  $f_r$  span against aliasing terms



greater than 1 LSB (presuming a "white noise" input). Re-stated, the filter needs to be designed so that  $f_{sb} \leq f_s - f_r$  to assure alias rejection of 6n dB over a frequency range of  $f_r$  with a sample rate of  $f_s$ .

As subsequently discussed, the aliasing phenomenon can also be used to advantage. It can be used to overcome the need for anti-aliasing filters when spectrum analyzing repetitive signals!

## EQUIVALENT TIME SAMPLING AND RIS

"Equivalent Time Sampling" (EQT) is a means of exploiting the aliasing phenomenon to increase the usable bandwidth of a digitizer by making it appear to sample more rapidly than its maximum ("single shot") sample rate. However, EQT is *only* applicable to stable, repetitive signals; it plays no role in the measurement of transient events. EQT can be implemented in at least three different ways, termed "sequential single sample", "sequential sweep" and "random interleaved sampling" (RIS).

The figure below illustrates sequential single sample EQT. At the first detected trigger, the digitizer acquires a single sample. It then waits for a second trigger. Upon receipt of the second trigger, a time delay equal to the reciprocal of the desired sample rate is executed and then the second sample

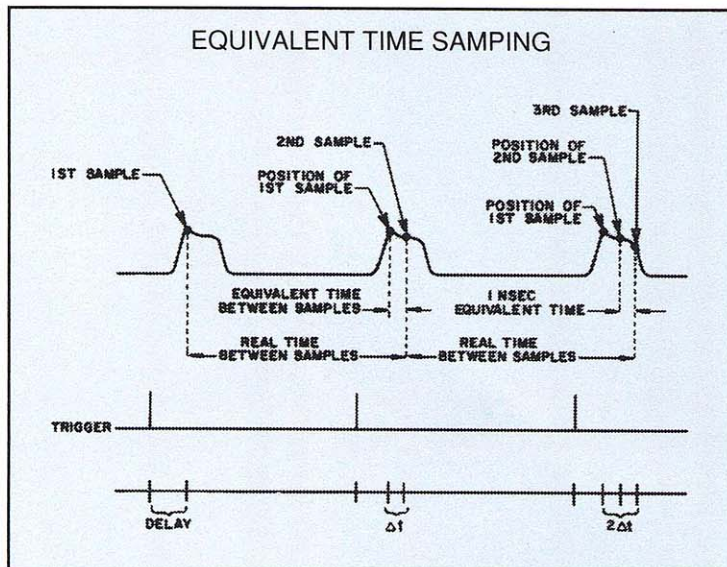

is acquired. The trigger-to-acquisition delay is incremented by the desired intersample period,  $\Delta t$ , for each subsequent acquisition. The resulting capture has an equivalent sample rate of  $1/\Delta t$ . Clearly this method is slow as N trigger cycles are required to gather N samples.

Sequential sweep EQT is more rapid because a sweep of samples spanning the desired display time range is acquired for each trigger. Here, N samples are acquired in M trigger cycles, where  $N = kM$ .

Upon receipt of each trigger, k sequential samples are acquired at sample rate,  $f_s$ . These are stored in every Mth location of the memory allocated for the N samples. The first sweep is acquired directly upon trigger receipt. Subsequent sweeps have an increasing delay between the trigger receipt and sweep initiation; the delay increment is  $1/Mf_s$ . At the conclusion of M sweeps, the N memory locations are occupied by samples with relative time separation of  $1/Mf_s$  with reference to trigger detection. Hence, the apparent sample rate is  $Mf_s$ .

Note that both of these methods gather samples *following* the receipt of a trigger. They provide no "pre-trigger" viewing capability, a major drawback of this technique. Random interleaved sampling (RIS), illustrated below, overcomes this shortcoming.

RIS uses a memory distribution scheme philosophically similar to that of sequential sweep EQT, but implemented differently. Again, data is gathered in multiple sweeps of k points at a sample rate of  $f_s$ . As with sequential sweep EQT, the equivalent sample rate is  $Mf_s$ . However, more than M sweeps will be required as the process is statistical in nature.

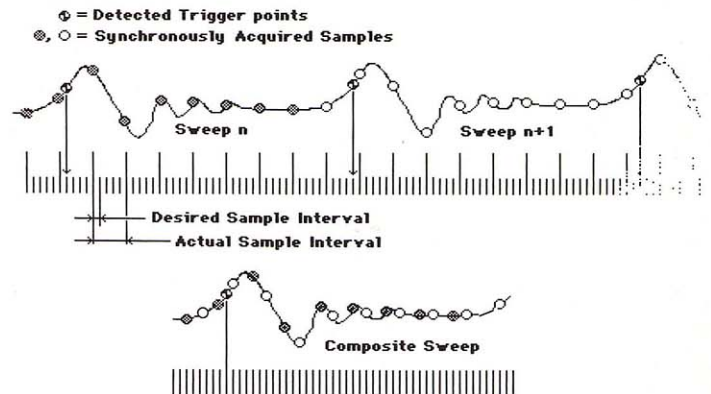



The ADC operates continuously, depositing samples in  $k$  memory locations that function as a “circular buffer”. That is, the newest sample replaces the oldest and the  $k$  most recent samples are always retained.

When a trigger is received,  $k$  points are retained and the buffer “seam” location area is indexed. Since the input signal is asynchronous to the sample clock, each trigger arrives randomly anywhere within a  $1/f_s$  sample interval. The arrival time of the trigger is measured relative to the next sample clock to a precision of better than  $1/Mf_s$ . It is quantized to one of the  $M$  potential “start times” sought.

Rather than issuing a sample or sweep command a known time delay after a trigger, each retained sweep is identified by an equivalent trigger-to-first-sample delay after its retention. The acquisition continues until all  $M$  required “start times” have been found.

Clearly, more than  $M$  sweeps will be required to achieve  $M$  uniquely satisfactory trigger arrivals. The first trigger received is qualified without exception as fitting in one of the  $M$  “arrival slots”. The second must match one of the remaining  $M-1$  required start times. Hence, as the acquisition proceeds, an ever increasing number of triggers must be rejected. The actual number of triggers,  $M_{act}$ , required to capture  $M$  sweeps each with a unique “start time is well modeled by:

$$M_{act} = M [.58 + \log_e(M)]$$

The  $N$  data points are displayed by interlacing the  $M$  retained sweeps based upon the recorded trigger arrival to first sample intervals. This amounts to aligning the randomly acquired sweeps upon a common trigger point, as shown. Because the triggers arrive after sweep initiation, pre-trigger information can be retained by simply adding an address off-set to the buffer “seam” location.



## Digital Signal Processing

Digital processing of acquired waveforms allows the user to make quantitative measurements of a variety of parameters. Because digital signal processing (DSP) is performed under the control of a computer or microprocessor, the technique provides answers which are ergonomic and more precise than the older analog technique. Because of the nature of digital recording, the advantages of pretrigger sampling and increased dynamic range are also provided.

DSP provides accurate measurements of waveform parameters like rise and fall times. Also, it allows processing after the fact without loss of any information. For example: Digital smoothing can provide signal to noise enhancement without losing the original signal. Also, as will be discussed later, transformations to the frequency domain allow information about the frequency content of a signal to be calculated.

When waveforms are stored as arrays of digital values, a variety of accurate measurements can be accomplished even for single shot signals. The digital computer used to control a waveform digitizer data acquisition system can be used to perform these waveform calculations, or if a microprocessor-based digital storage oscilloscope is used, the microprocessor can perform the calculations without transferring the data to the computer.

A variety of measurements can be made using "digitally derived cursors". For example, a typical 10-90% risetime measurement is shown in Figure 1. This measurement was made using a LeCroy 9450 400 Msample/sec DSO.

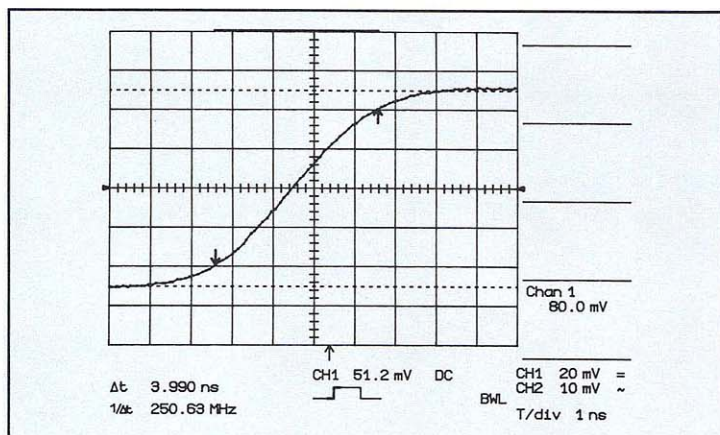

Figure 1. Risetime Measurement 10-90%

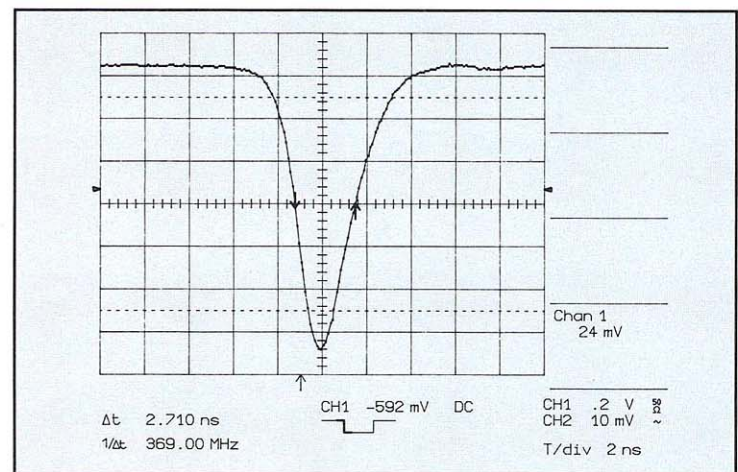

Figure 2. Pulse Width Measurement,  $\Delta t$

As a second example (Figure 2), the FWHM of a pulse is recorded using the LeCroy 9450 DSO. The number of significant figures is a consequence of the large number of samples within the oscilloscope.

Similarly, the time difference between two single shot pulses is recorded using a LeCroy 9450 400 Msample/sec DSO. See Figure 3.

Other parameters which can be measured with cursors include peak-to-peak swing and waveform overshoot.

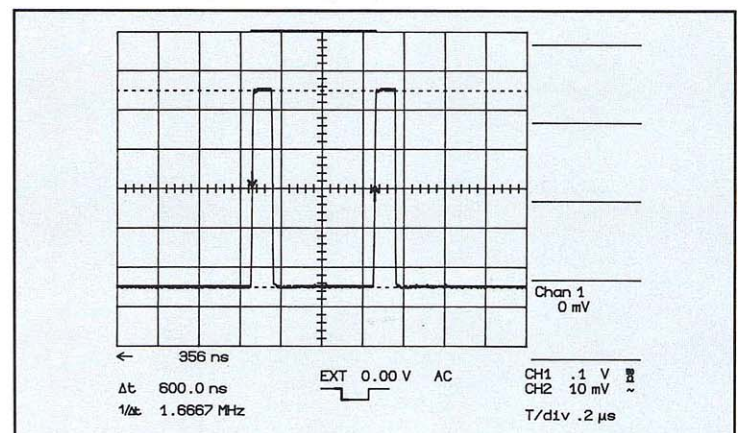

Figure 3. Time Between Pulses,  $\Delta t$



A second consequence of the digital nature of the storage is the ability to produce calculated waveforms. For example, Figure 4 shows the pressure waveform associated with a sonic transducer.

Also, the square of the waveform, the power, is calculated and displayed on the screen. The integral of the power showing the energy in the pulse is shown in the bottom trace.

Other examples of calculated waveforms include power and dynamic impedance when voltage and current are measured, linearity ( $V_{out}/V_{in}$ ) and absorption ( $V_{out}/V_{in}$ ).

In some applications, the signal may be repetitive but may vary in shape or structure. If the information to be gathered is the variation (e.g., phase or amplitude jitter) an algorithm can be used for selecting the "extrema" of an ensemble of waveforms on a point-by-point basis. The waveform made up

of all of the maximum values is called the Roof and the minima, the Floor. The total range of phase jitter can be measured in this way (see Figures 5 and 6).

The technique allows variations in amplitude to be recorded. For example, a sinusoid which has amplitude modulation can be characterized. Also, the same algorithm allows rare "glitches" to be found. See Figure 7. This rather dramatic measurement can be used to solve design problems which would be totally overlooked by an analog oscilloscope.

In some applications, the noise in a signal may obscure the information of interest. If the signal is a single-shot event, a signal-to-noise enhancement may be achieved by "digital smoothing". This technique involves generating a waveform in which each point is replaced by an average of itself with its nearest neighbors, two nearest neighbors, or three or four.

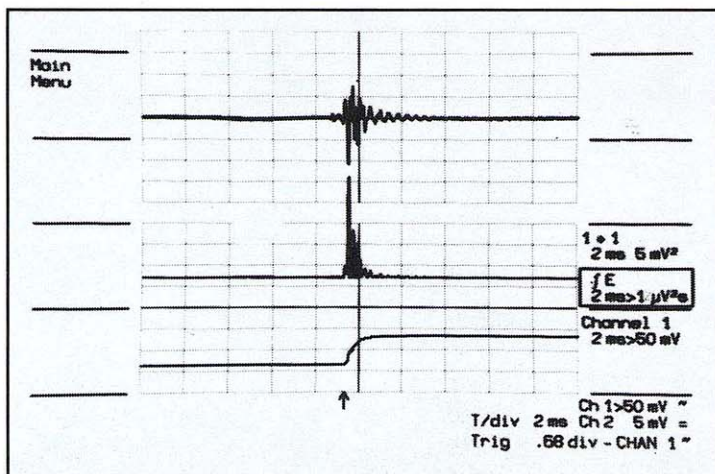

Figure 4. Pressure Power Energy

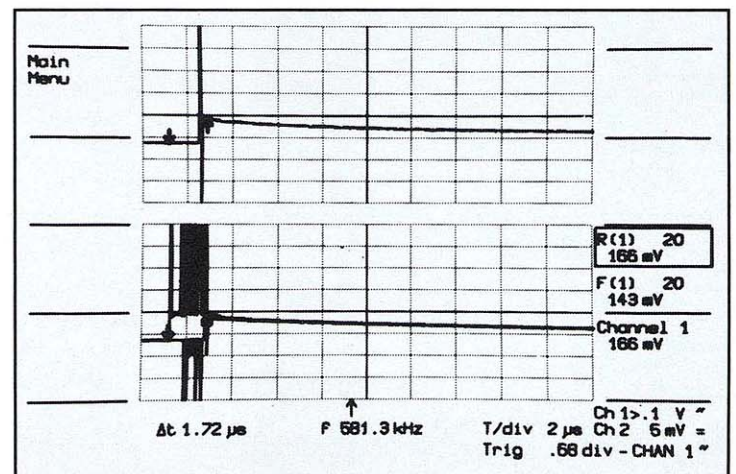

Figure 6. Extrema

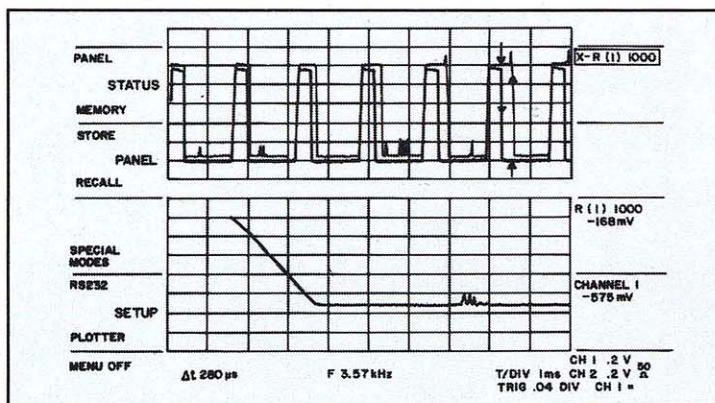

Figure 5. Roof and Floor

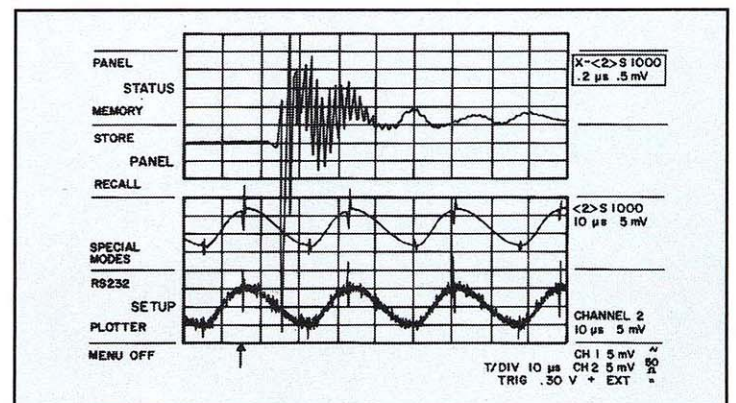

Figure 7. Glitches



# Technical Tutorial

This is called 3-, 5-, 7-, or 9-point smoothing. Figure 8 indicates 3-point smoothing.

As an example, the waveform captured on the 9400 shown in Figure 9 exhibits high frequency noise. Shown on the lower trace is a 9-point smoothed version of the same signal.

As can be seen, the smoothing is similar to the noise versus bandwidth trade-off which is typical of amplifier design. As a consequence, a signal is an excellent candidate for digital smoothing if it has been oversampled and the noise bandwidth exceeds the signal bandwidth. Digital smoothing produces results which are similar to those from a low pass filter. Alternately, one thinks of the oversampling as equivalent to recording each amplitude point more than once. Oversampling is similar to treating a single shot waveform as a repetitive waveform and performing waveform averaging.

Another example of digital smoothing is shown in Figure 10. In this case, the noise bandwidth greatly exceeds the signal bandwidth. As a consequence, the results of smoothing are dramatic.

If a good trigger signal can be obtained in conjunction with a repetitive waveform, signals which are plagued with noise can be significantly cleaned up by "averaging". Without a good trigger the repetitive waveforms cannot be correctly

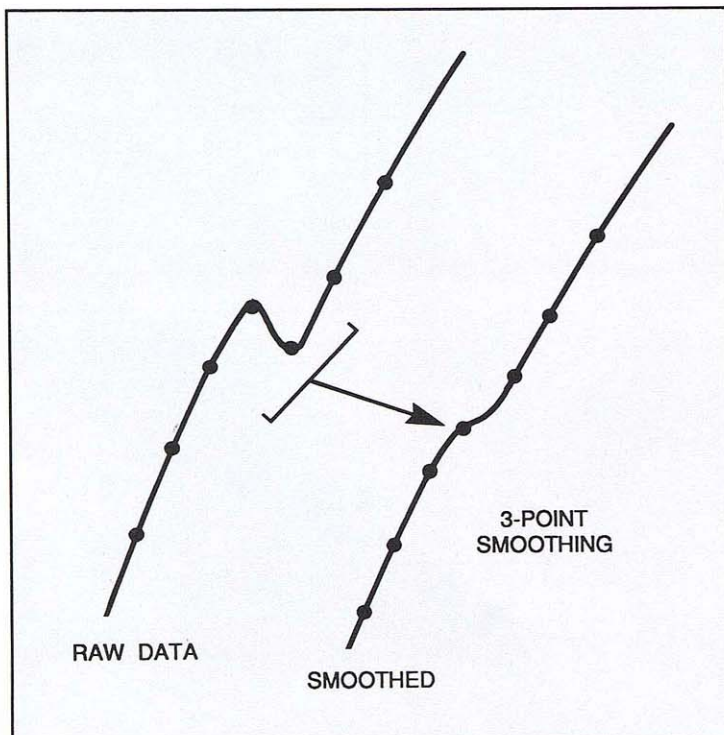

Figure 8. Three Point Smoothing Technique

overlayed. With a good trigger, the effect of coherent signal and incoherent noise is obtained. In Figure 11, a noisy signal is shown.

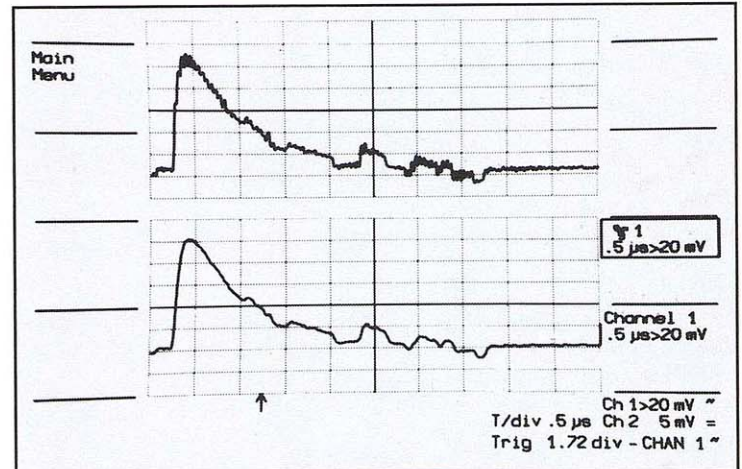

Figure 9. Smoothing Applied to Digitized Signal

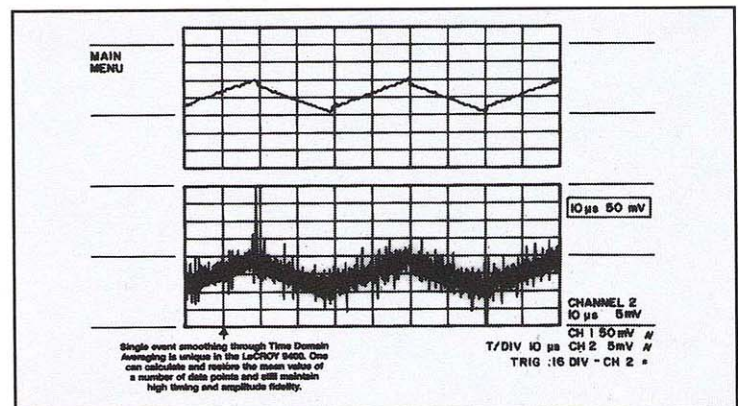

Figure 10. Smoothing of Sawtooth

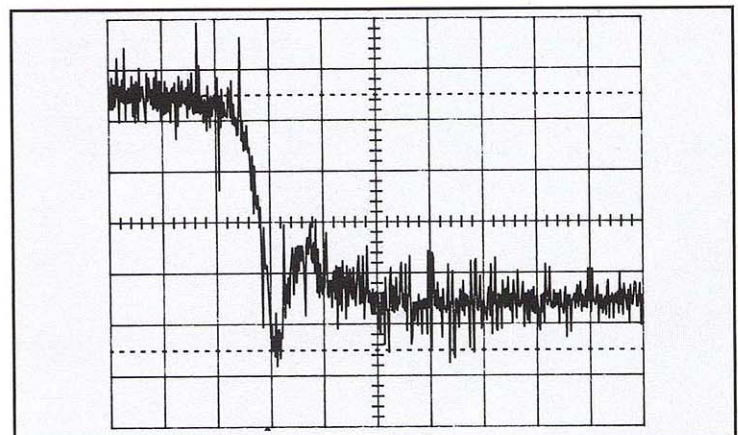

Figure 11. Noisy Signal



In Figure 12 the same signal is shown after averaging 1000 waveforms. The reduction of noise in the averaged signal is apparent to the eye. To illustrate the dynamic range enhancements of averaging, a noisy signal with a high frequency repetitive glitch was captured and averaged. The top trace in Figure 13 shows the signal as it was first captured. After averaging, the "noise" disappears, as in the second trace. The bottom trace shows an expansion of the resultant clean glitch. Note the structure now visible, making detailed analysis of the glitch characteristics possible.

Another method of noise reduction involves the process of digital filtering. The "high resolution" mode on newer digital oscilloscopes, such as LeCroy's 7200 Series, 9450, 9420, and 9424, effectively eliminates high frequency noise. Figure 14 shows a single-shot waveform recorded via real time sampling. The same signal is then shown in Figure 15, after a 3-bit resolution enhancement is invoked. In this particular case, the risetime is somewhat compromised due to the bandwidth limitation. However, lesser bit enhancements can

easily be selected to avoid changing the signal's inherent characteristics.

In some cases the signal of interest occurs repetitively for only a while. If this time interval is not known, then averaging over a longer time which is known to include the correct interval will not produce the desired result.

Rather, the true signal will appear diminished in amplitude by the ratio of the number of waveforms containing the signal of interest to the total number of waveforms recorded.

To deal with this a technique called "continuous" or exponential averaging is employed. Using this technique, as each waveform is acquired, it is added to the ensemble with a greater weight than any other. In this way, the past is exponentially forgotten. The formula for 1:N weighting is  $F^1(n) = (N F(n) + D(n))/(1+N)$ . Here  $F^1(n)$  is the new average,  $F(n)$  is the old,  $D(n)$  is the latest observation, all for the n-th time bin.

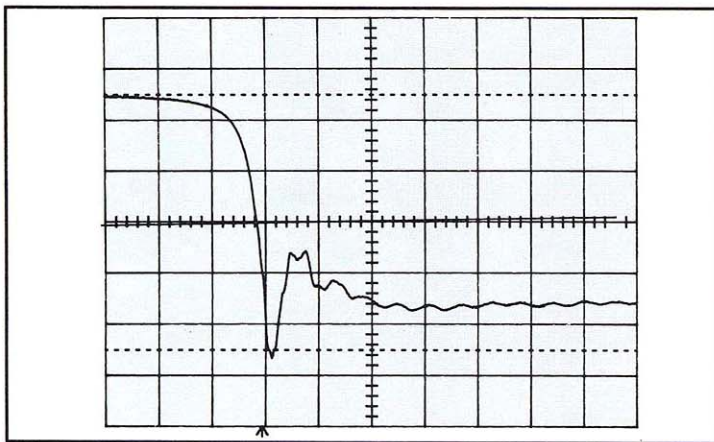

Figure 12. 1,000 Averages

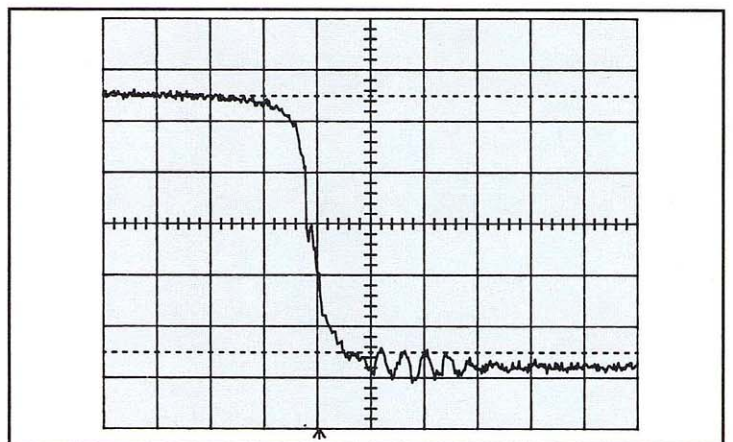

Figure 14. Recording of Waveform Transition

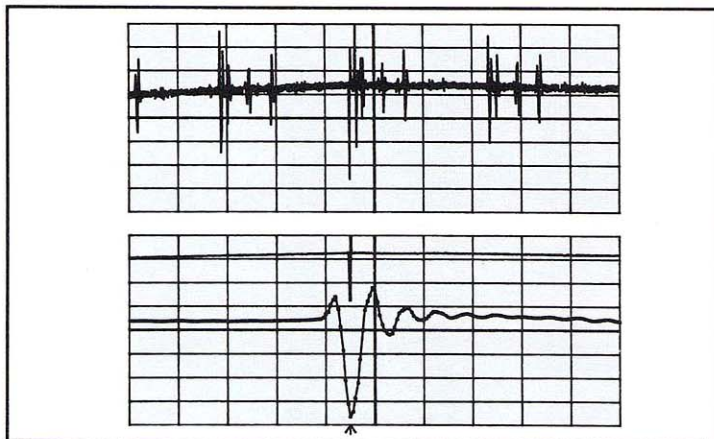

Figure 13. Locating and Expanding a Glitch

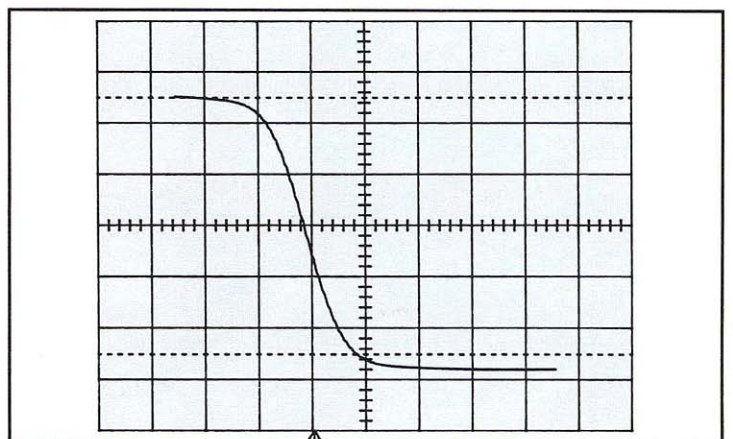

Figure 15. Waveform in Enhanced Resolution Mode



# Technical Tutorial

If the noise in a signal is less than an LSB, averaging will not enhance dynamic range of a waveform. The average of a column of identical numbers provides no additional significant figures. A waveform with such low noise can show a similar enhancement through a technique called "dithering".

This technique consists of adding a small (1 least significant bit) offset to a signal. The offset level is varied shot-to-shot and the digitized waveforms are averaged. This offset allows each point on the waveform to be "interpolated" to higher precision than could be achieved as a digitized single shot. By averaging many waveforms, the overall precision which can be achieved is limited by the DAC rather than ADC. This means dithering (and averaging) can improve the dynamic range available from the A/D.

If the dithering noise is digitally generated it is possible to produce a pseudo random sequence with a flat distribution, but then the resolution improvement is limited by the finite steps available in the noise amplitude. That is, if the noise can only reach eight values between A/D codes, then we can't expect more than eight times improvement regardless of the number of averages.

If the dithering noise is produced by an analog process, it can reach all values, but its distribution will probably not be flat. Although it is possible to calculate the signal value with any symmetric noise distribution exceeding 1 bit of the A/D, it is only as simple as demonstrated above if the distribution is flat across one code space. In this case, the mean value always approaches the center value of the distribution. If the noise amplitude over time is Gaussian distributed, for example, this is not the case. How does one make a Gaussian distribution nearly flat across one code? Make it wider. When the dithering noise is wider than one LSB, the effect of the shape of the noise amplitude distribution is reduced.

ACQUISITION PARAMETERS			
	Chan 1	Chan 2	
<b>VERTICAL</b>			
Fixed V/div	.2 V	5 mV	
Total V/div	200 mV	5.00 mV	
Offset	24 mV	-1.40 mV	
Coupling	DC 1 MD	DC 1 MD	
<b>TRIGGER</b>		Time/div	10 ns
Delay	25.2X Pre	Time/pnk	200 ps
Level	-.14 V	Points/div	50
Coupling	DC	Interleaved	
Source	EXT	Sampling	ON
Slope	-	BM-Limit	ON
Mode	SINGLE	# Segments	15
		For SEGANCE	
	Trigger Level has absolute meaning with DC-Coupling only		

Figure 16. Setup of 9400A

Figure 16 shows the setup menu of the LeCroy Model 9400A. As can be seen, it provides an offset adjustment for each analog channel. As this adjustment is made using a DAC, the 9400A can vary its offset digitally. As a consequence, the 9400A employs the digital technique for dithering.

Dithering by more than one LSB can also reduce the effects of differential non-linearity on an averaged result, since the mean value of the average reflects the probability of the signal being quantized to many different levels. The effect of the inaccuracy in any one level is reduced by the effect of the other correct quantization levels, and errors at different levels in opposite directions tend to cancel out.

In summary, both a signal-to-noise improvement and a dynamic range response enhancement can be achieved by averaging. This requires a synchronous trigger. Theoretically, the improvement is proportional to the square root of the number of waveforms which were recorded. Selection of continuous or summation averaging depends upon the nature of the effect. If the effect under study persists, summation averaging is preferred.

In some applications, the shape of a signal (for example, its risetime or its overshoot) is important. These features are obtained by interrogating the signal in the "time domain". This is the domain of amplitude (voltage current, pressure, etc.) versus time. The time domain information is the waveform which normally appears on an oscilloscope or is captured by a transient recorder.

In some cases the information is contained in the frequency content of the signal. In this case, one could obtain the "frequency domain" information by using a series of narrow band pass filters. As an alternative, a computational technique called the Fourier Transform can be used based upon the digitized waveform. See Figure 17.

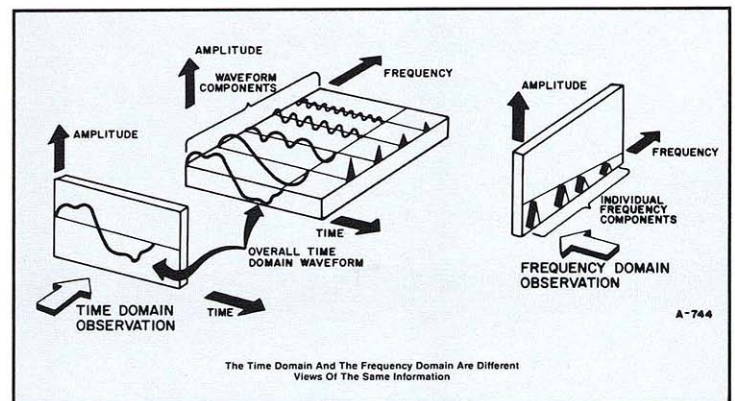

Figure 17. 3D Fourier Theory



The frequency domain is part of every day experiences. One's ears act as a Fourier analyzer. For example, it is easy to detect anomolous frequency components emanating from an automobile engine. This can mean bad rod bearings or bad main bearings. In recent years, DSP has been useful for diagnostics of jet engines.

Non-linear systems reveal themselves in the frequency domain. For example, amplifiers which exhibit input saturation (concave downward) produce odd harmonics. Devices with response curves which are concave upward exhibit intermodulation distortion.

The Q of a resonant circuit is a phenomenon which has meaning in the frequency domain. Wideband noise applied to a circuit is passed by the circuit in varying amounts. The Fourier decomposition of the output is peaked with a FWHM proportional to  $1/Q$ .

In practical digital signal processing applications, an approximate algorithm is normally employed called the "Fast Fourier Transform" (FFT). This approximation has no practical effect upon the data other than to shorten the time required to make the calculation.

Frequency domain analysis can often provide information which is completely obscured in the time domain. For example, the sine wave shown in Figure 19 contains "harmonic content" which is not apparent in the time domain. In the frequency domain the harmonic content is obvious.

Figure 18 shows a variety of waveforms and their Fourier Transforms. In general, the waveforms which are broadest in the time domain show the narrowest spectrum in the frequency domain. As examples, note the triangular wave has a rolloff of 12 dB/octave. In comparison, an impluse has a Fourier Transform with a  $\sin(t/T)/(t/T)$  response. Because the impulse is so broadband, it is particularly useful for probing, for example, oil exploration applications.

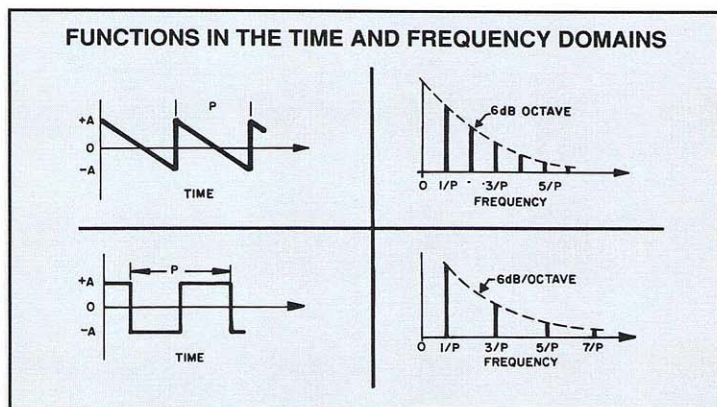

Figure 18. Typical Fourier Transforms

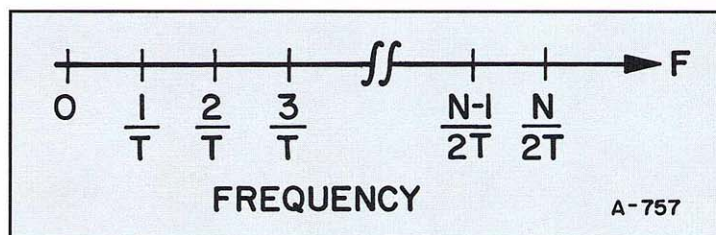

Figure 19. Frequency Produced

The FFT provides phase and amplitude information for each frequency bin which it calculates. For most applications, the amplitude (power density) information is of interest. Because of the wide dynamic range of the frequency content, it is customary to report the amplitude in dB.

For a waveform comprising N data points over a time interval T, the frequency binning action of the FFT is shown in Figure 19. The maximum frequency analyzed,  $N/2T$ , is the Nyquist Limit. (ie,  $f_N = f_s/2 = (N/T)/2 = N/2T$ , where  $f_N$  is the Nyquist frequency and  $f_s$  is the sampling frequency.) Within this range, the frequency bin size is dependent upon the number of points sampled. To illustrate the effect of sample size, a 200 point FFT is performed on 400 time domain samples of a sine wave recorded at a specific sampling rate. The FFT is shown in Figure 20. Note the width of the main spectral peak.

In contrast, 1000 point FFT is performed on 2000 time domain samples of the same waveform, recorded at the same sampling rate (ie, 4 times more cycles of the sine are Fourier transformed). The FFT is shown in Fig. 21. The frequency spectrum has 4 times better resolution than the FFT performed on fewer time samples. Fig. 20 indicates a typical result from a signal analyzer, while Fig. 21 indicates the increased resolution which can be achieved with the digital technique.

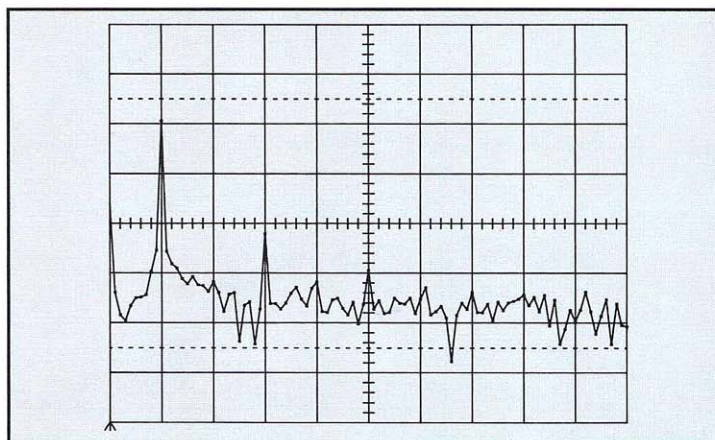

Figure 20. 200 Point FFT - 100 KHz Sine Wave



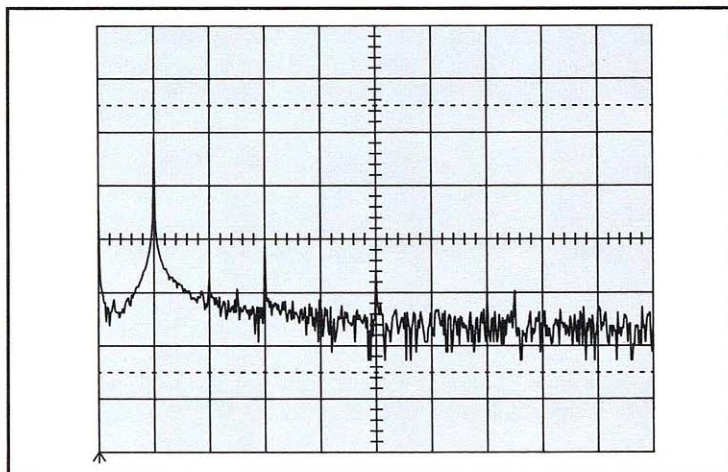

Figure 21. 1000 Point FFT - 100 KHz Sine Wave

In physical applications, a finite duration of record is recorded. As a consequence, the data have the equivalent of a square window weighting, that is a weighting factor of one as applied to all data within the sample time and zero for all data outside. This has the effect of the window mapped onto each Fourier filter and hence a monochromatic line will produce a peak with the characteristic  $\text{sin}X/X$  response mentioned above. This effect is not a mathematical artifact of the FFT and would also be found with a signal analyzer or a set of discrete filters if a finite time sample were applied to it.

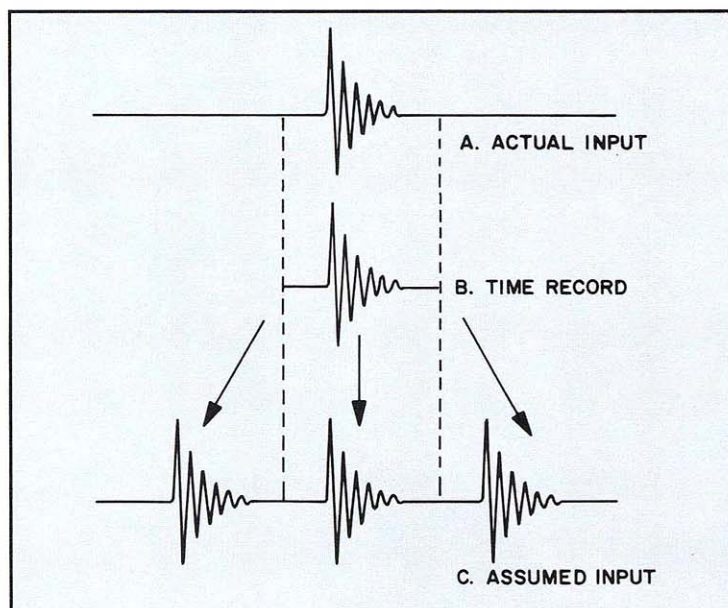

Figure 22. Periodic Assumption

The Fourier transform assumes that the signal is periodic with a frequency  $1/T$ . See Figure 22. If the waveform is not periodic in the window, the end points will not match each other. A consequence of this is that the assumed waveform has a discontinuity. See Figure 23. This implies high frequency components. These can be seen in the frequency domain. See Figure 24.

In order to eliminate the effects of the discontinuity it is common to apply a window to the time domain data before calculating the FFT. Unlike the rectangular window, often the purpose of such a window is to drive the endpoints in the time domain smoothly to zero, thus eliminating the high frequency tail described above. See Figure 25. Several typical windows are shown in Figure 26.

The windows are characterized by several properties. The most important ones are the 3 dB bandwidth and the amplitude of their highest side lobes. In general, the various window functions trade off bandwidth versus side lobe suppression.

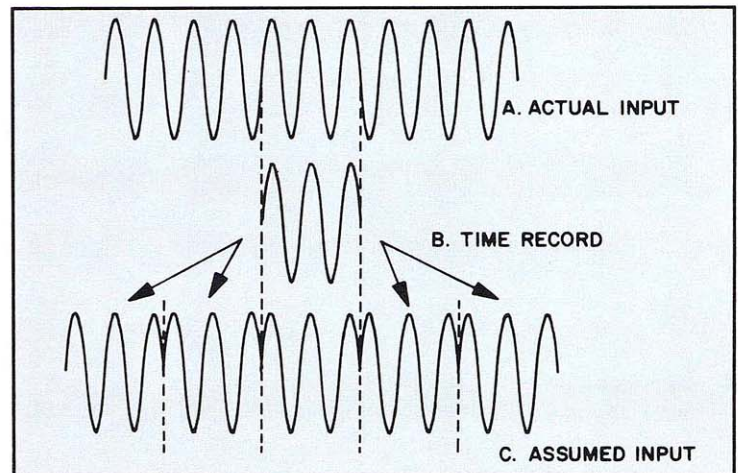

Figure 23. Discontinuous Sine Wave

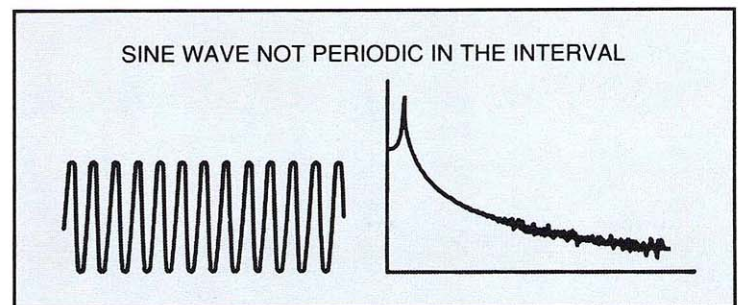

Figure 24. Discontinuous Sine in Frequency Domain



Depending upon the application, one or the other of these features is most important. Because the bandwidth of the FFT is comparable to the point spacing, the response to a single frequency component will depend upon the exact value of the frequency. If it is located midway between two frequency bins, the measured frequency amplitude will be smaller than one of frequency located on a frequency point. See Figure 27.

In comparison, a wider bandpass provides a flat top response and a lesser variation in measurement accuracy.

The Hanning window produces up to 1.5 dB attenuation of line intensity in comparison to wider functions like the Kaiser or Panzer functions which have about 0.1 dB variations. To see the effect of windowing, a frequency domain spectrum was calculated from the time domain dataset used in Fig. 21, using both Hanning (Figure 25) and Hamming (Figure 28) windows.

Compare the width of the fundamental frequency peak for the two spectra. Note that the spectrum acquired with Hamming windowing is significantly narrower. However, the line has a significant tail. Also, harmonics stand out over the background much more than do the harmonics for the Hanning windowed spectrum. Thus, to detect the presence of spectral lines, the Hamming window is better.

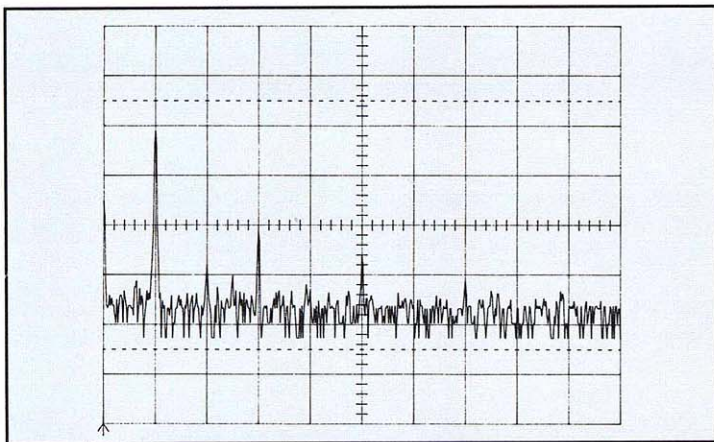











Figure 25. Smoothing - Hanning Window (von Hann)

TABLE SPECTRAL CHARACTERISTICS OF WEIGHTING FUNCTIONS					
WEIGHTING FUNCTION	3-DB BANDWIDTH	HIGHEST SIDELobe LEVEL (dB)	WEIGHTING FUNCTION	3-DB BANDWIDTH	HIGHEST SIDELobe LEVEL (dB)
RECTANGLE 	$0.85 \beta$	-13	HAMMING = $(\text{COSINE})^2 + 0\% \text{ PEDESTAL}$ 	$1.3 \beta$	-42
TRIANGLE 	$1.25 \beta$	-26	TRIPLET = $(\text{COSINE})^2 \times \text{EXPONENTIAL}$ 	$1.5 \beta$	NONE
COSINE 	$1.17 \beta$	-23	KAISER (K=10) 	$1.75 \beta$	-74
$(\text{COSINE})^2$ HANNING 	$1.4 \beta$	-32			
$(\text{COSINE})^3$ 	$1.61 \beta$	-39			
$(\text{COSINE})^4$ 	$1.80 \beta$	-48			

$\beta = \text{RECIPROCAL OF WEIGHTING FUNCTION LENGTH}$

Figure 26. Typical Windows

Because of the picket fence effect, the Hanning is better if the amplitude of the various lines must be measured accurately. Averaging of frequency spectra differs from averaging of time domain records in how the noise is treated. Random noise averages to zero in the time domain. In the frequency domain, however, the noise has a characteristic spectrum and thus does not average to zero. Rather, the effect of averaging of multiple frequency spectra is to eliminate statistical fluctuations and to smooth the noise spectrum. It is often useful to record signal plus noise and then separate noise only and compute averaged frequency spectra. By subtraction, the background can be eliminated.

If a synchronous trigger can be established, it is possible to do time domain averaging and then calculate the frequency spectrum after the noise has been averaged.

In summary, data recorded digitally can be processed in a variety of ways—in the frequency domain, the time domain, or both. When you select a digital instrument, your DSP requirements should play an important role in your selection. If your processing requirements vary from measurement to measurement, a dedicated firmware-based system should be your choice. Otherwise, consider a computer-based system to allow complex custom DSP algorithms.

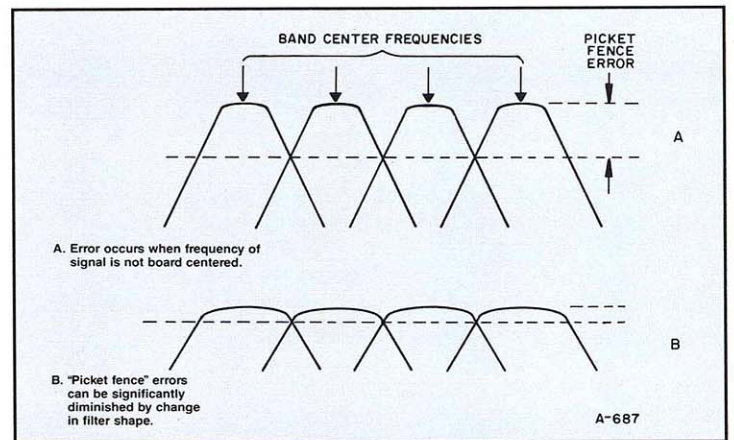

Figure 27. Hanning Picket

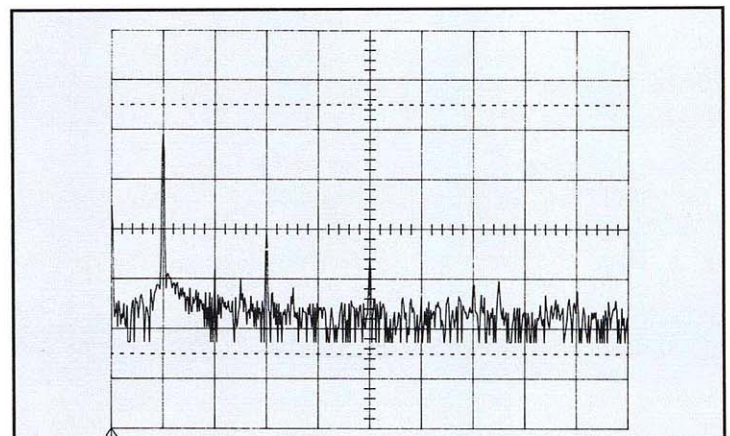

Figure 28. Hamming Window



# The Hows and Whys of Arbitrary Function Generators

---

## Introduction

The Arbitrary Function Generator (AFG) provides the user with the ability to generate custom waveforms. As such, it is ideally suited to automated testing and extensive circuit characterization during the design phase. Using a custom stimulus waveform and measuring the response waveform provides a realistic characterization of the device under test. Features unique to an AFG allow it to make extremely long intricate waveforms which are impossible with its analog counterpart. It also allows the user to vary the size and shape of a small section of the waveform. In the following sections, the utility of AFG features is described and interpretation of AFG specifications is discussed.

### STIMULATING QUESTIONS

Suppose you need a stimulus signal which is not a repetitive sinusoid. Rather, it is a sine wave several cycles long with intermittent base line segments and a few square waves thrown in. How do you generate it?

You have just designed a sophisticated communications system, but your normal test gear cannot test your new encoding schemes. How can you test it?

Your computer disk test system needs to detect missing bits accurately and your standard function generator does not provide the interactive flexibility you need. How can you do it?

Until recently, the answer to all of these questions was to design a stimulus yourself. However, today's technology has reached the level at which a do-it-yourself approach is no longer necessary because an AFG will probably do it for you.

### CHOOSING A SIGNAL SOURCE SOLUTION... THE AFG CONCEPT

Experience often influences users to choose standard signal generators. This is why many users still attempt to make do with the limited number of repetitive waveshapes provided by the traditional function generator. Typically only a standard set of cookbook waveforms such as sine, square, triangle and sawtooth is available. Real-world signals are seldom so

simple and require more sophistication than these waveshapes provide. This is the main impetus for the creation of arbitrary function generators.

The AFG allows the user to emulate virtually any system output. In so doing, it eliminates the need to build special circuits or systems and allows generation of almost any waveshape imaginable. In addition, the AFG is based on a microprocessor and provides the programmability, repeatability and reliability synonymous with today's digital technology.

### WHEN TO USE AN AFG

- When you need a non-standard real-world stimulus
- When you need an ATE programmable stimulus
- When the repeatability of memory storage is important
- When cost effectiveness is required.

The AFG can be used whenever a real-world event must be duplicated. With only a few constraints, an AFG can generate almost any custom signal within the bandwidth limits of the unit. Because an AFG stores waveshapes in RAM, these files can be archived and saved for future reference.

In many instances, an AFG can replace a rack full of other signal sources since it can also produce modulation, frequency sweep, pulses, standard functions and digital patterns. It is actually a universal signal source.

## The Basic AFG

### AFG TECHNOLOGY

An arbitrary function generator converts digital arrays into an analog waveform. Digital data stored in the AFG memory, are sent through the output DAC and amplifier as orchestrated by a microprocessor. See Figure 1.

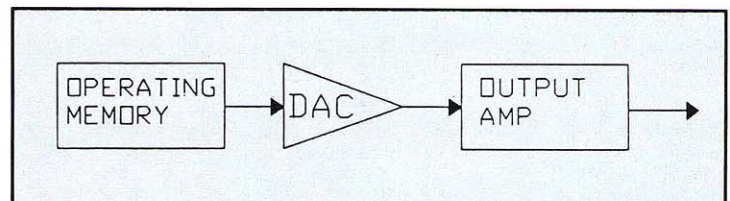
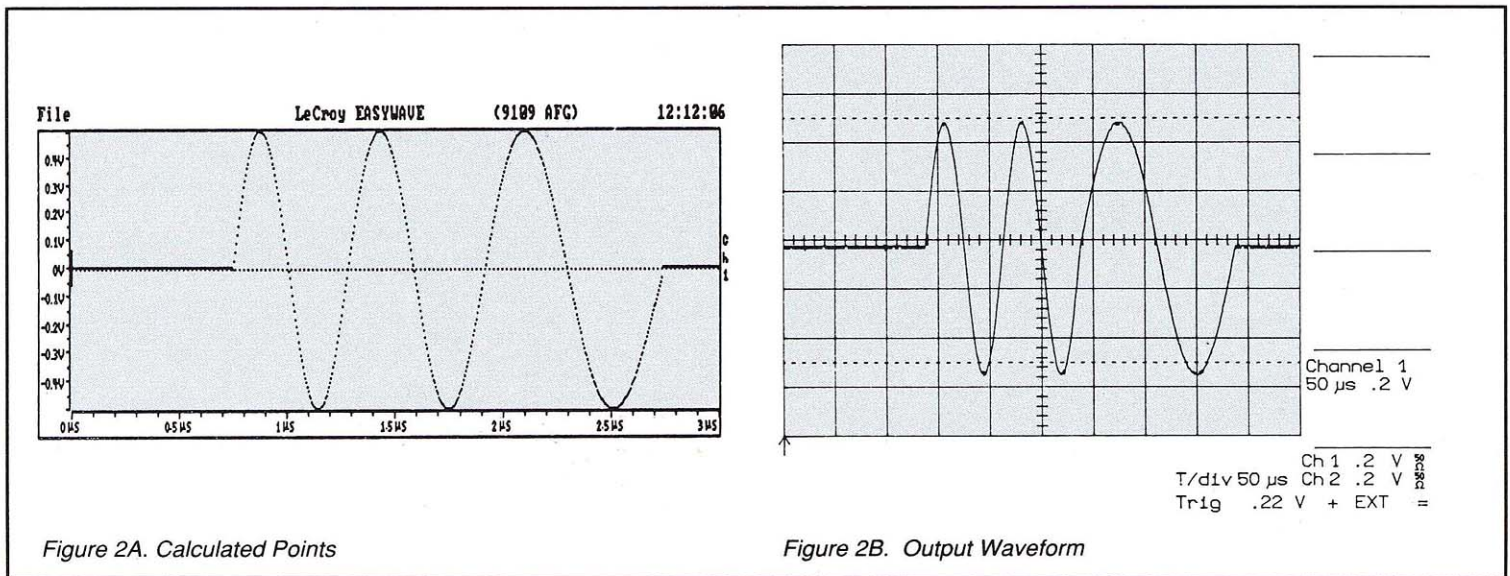

Figure 1. The Basic AFG





The brain of an AFG is the microprocessor. The CPU must not only coordinate and record all digital transactions with the memory, but also must coordinate communications over the GPIB or RS-232 bus when called upon. In addition, the digital circuitry in the AFG is called upon to perform a variety of high-speed data handling operations, all at the full speed of the AFG. These advanced functions are described in the Extended AFG Functions section below.

The user can produce a variety of waveforms by loading them into the AFG memory as a list of digital values. The waveform list is accessed digitally and played back either as a single-shot or repetitively. Each digital value is applied to the digital-to-analog converter which in turn produces a corresponding voltage. Then the next value is accessed from memory and applied to the DAC, producing the next output voltage. In this way, a series of calculated points (Figure 2A) becomes a series of analog levels which map out the waveform (Figure 2B).

AFG's are direct digital generators which employ a timebase made up of a phaselocked loop. The phaselocked loop, a form of a stabilized oscillator, provides a very stable timebase.

Finally, some AFG's even provide non-volatile storage memory or a second output channel. The memory can be used to

archive waveform data. The second channel output can be summed onto the first, making possible interactive parametric variation.

### CREATING CUSTOM WAVEFORMS WITH AN AFG

Actually, the AFG waveform file is a simple digital data array. AFG's typically provide many different methods of entering this information into the generator. Waveforms can be created by:

- equation entry
- simple element selection
- digital data arrays
- acquisition from a digital scope
- standard functions
- tablet entry
- any combination of the above

These many waveform creation utilities are enhanced even more by waveform creation software available with some models. Cut and paste, scaling, and the ability to accomplish algebraic operations on any of the above waveform creation techniques magnify the possibilities still further.



Commercial arbitrary function generators are available with writing rates of 1-800 Mpoints/sec. They provide a DAC resolution of 8-12 bits. However, the combination of the maximum speed and the maximum number of bits (with corresponding bandwidth/signal-to-noise ratio) is beyond the state-of-the-art.

Using the basic AFG described above provides advantages to the user which cannot be attained in any other way. These advantages are:

## Real World Waveforms

The AFG is not limited to standard waveforms, such as sine waves, square waves or sawtooths. Instead, video signals, disk read/write signals and many other signals are possible. As an example, a Loran C waveform can be accurately represented:

$$V(t) = t^2 \exp^{-t/T} \sin(\omega t)$$

Here T is the decay constant of the waveform and  $\omega$  is  $2\pi$  times the frequency of the carrier. This waveform is shown in Figure 3.

## Repetitive Playback

A single-shot waveform like one from a fuse blowing or an explosive test can be captured with a digital oscilloscope or a transient recorder, or simulated with equations. When loaded into the AFG, the waveform can be played back repetitively. This allows the user to study the response of a circuit and set it up under real-world conditions using only conventional tools like an analog oscilloscope.

## GENERATING ARBITRARY WAVEFORMS

An AFG waveform file is simply a collection of digital samples representing the waveform amplitude levels to the AFG's D-to-A converter. Suppose the AFG employed an 8-bit DAC. Then, waveform files for this AFG would have digital data levels encoded from 0 to 255. Since the digital samples are vertically oriented (i.e., represent amplitude information), the horizontal timing of any particular level is set by the AFG clock period. This provides the ability to maintain the same waveform file, yet vary the frequency to match the application. By clocking the memory/DAC from a phase-locked loop oscillator,

the frequency content of the desired waveform can be adjusted, typically to a precision of several parts in  $10^4$ . In Figure 4, two versions of a single waveform are shown, one based upon a 200 MHz clock and the other based upon a 190 MHz clock. The 190 Mpoint/sec waveform is clearly lower

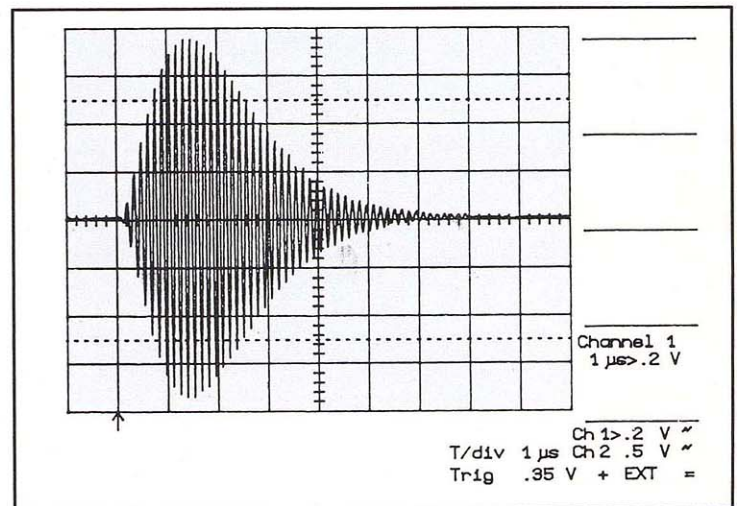

Figure 3. A Loran C Waveform

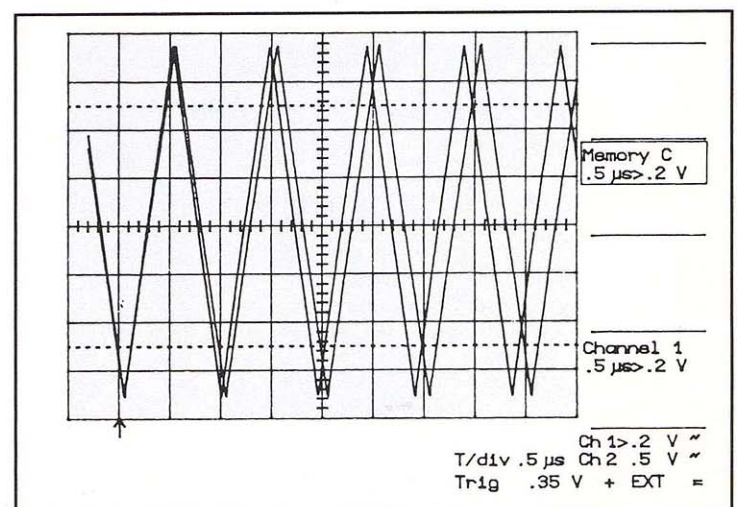

Figure 4. Clocking at Two Frequencies



in frequency content than the 200 Mpoint/sec waveform. The signal conditioner in an AFG includes a series of programmable amplifiers and attenuators. While the dynamic range of a single signal is limited by the number of bits of the DAC (typically 8-12 bits), the amplifier/attenuator allows the AFG to produce signals of varying amplitudes from several mV to several volts.

By virtue of the discrete nature of AFG programming, waveforms are actually a staircase of the programmed values. See Figure 5A. Note the plateaus in the waveform. In order to produce a smooth waveform, most AFG's provide a series of user-selectable low-pass filters. By selecting a filter with a pass frequency somewhat higher than that of the waveform, the plateaus can be rounded out of the waveform. See Figure 5B. The filters can also play an important roll in determining waveshape. If a sawtooth is heavily filtered, the resulting waveform is a sinusoid. This fact allows the user to produce waveforms of a frequency of up to half the sampling frequency. This fact can be useful in producing the waveshape required for MIL-STD 463C EMI testing. As an example, a damped sawtooth is given by:

$$V(t) = e^{-(t/5)} \cos(\pi t), t = 0, 1, 2 \dots \text{samples}$$

The factor  $\cos(\pi t)$  produces a sawtooth because the variable  $t$  is the number of waveform samples and as such can assume only integer values.

The resulting waveform as captured on a digital oscilloscope is shown in Figure 6A. In this case, the waveform generator was operated at a rate of 50 Mpoints/sec with a circuit bandwidth of greater than 100 MHz. In Figure 6B, the same waveform is displayed. In this case, the waveform was produced at 200 Mpoints/sec with a filter set to 100 MHz. Note that the resulting waveform is a high quality sinusoid with user programmable damping ("Q"). Therefore, the feature of programmable filtering can be used to help establish the desired waveshape.

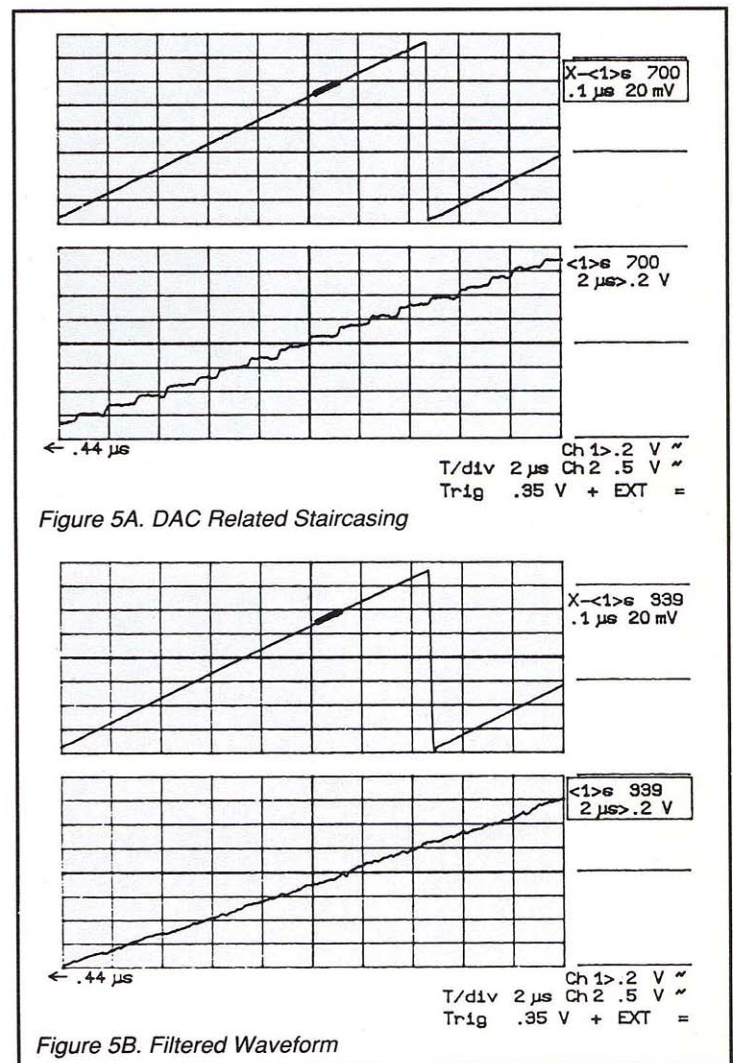

## FLEXIBLE TRIGGER MODES

Often an application requires more than simply continuous regeneration of the same signal. AFG's offer many different and useful trigger modes. Depending on the application, these trigger modes can offer additional customizing all their own. Common trigger modes are continuous, burst, single, recurrent and gate.

Recurrent trigger mode allows the user to vary the amount of time between waveform repetitions. This can be a powerful capability to allow variable pulse widths or randomly varying amounts of dead time between bit streams.

Gate trigger mode can work in conjunction with another system signal that provides the AFG with a window of time in



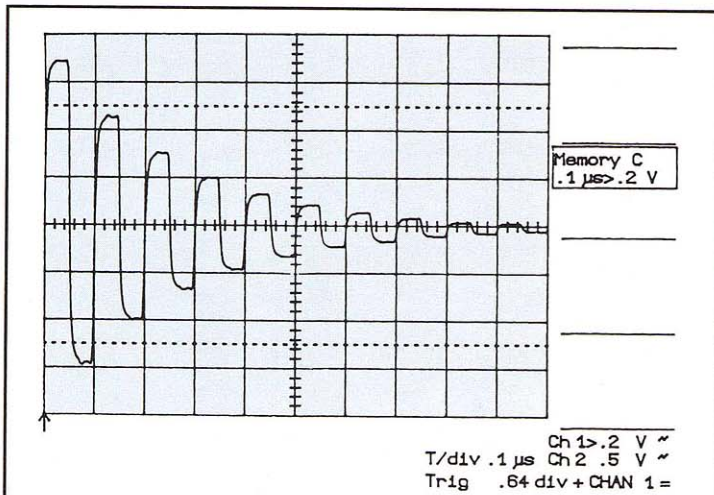

Figure 6A. Unfiltered Damped Sinewave

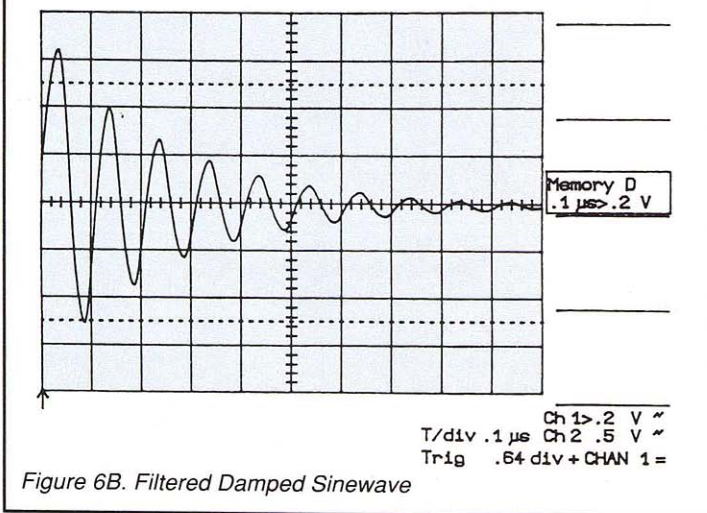

Figure 6B. Filtered Damped Sinewave

which to output signal. This ability is very useful in phased array radar testing or ultrasonics to synchronize the AFG stimulus to the system under test.

Single-shot events, such as switch-mode power supply inrush current spikes, can be captured by a digital oscilloscope. The data in acquisition memory can be sent to an AFG with

the aid of a computer controller. There it will be played back repetitively, in continuous trigger mode, to allow the user to study and further characterize the defects of the spike on the rest of the system.

## Extended AFG Functions

### TWO CHANNELS ARE BETTER THAN ONE

Some AFG's offer two channels in a single instrument or offer the ability to synchronize two independent instruments. By operating two channels off of a single sampling clock, two waveforms can be precisely synchronized. This allows waveforms to be produced together either as a single shot or repetitively. The ability to synthesize multichannel arbitrary waveforms greatly enhances the utility of the AFG. The following applications require multiple channels:

**Radar Simulation:** The output from a receiver is typically made up of two signals -I and Q. The AFG can be used to produce such a signal pair for the purpose of testing and characterizing the signal processing circuitry that follows the receiver.

**Magnetic Disk:** Channel 1 can be programmed to produce the head output and Channel 2 can produce the index signal. Additionally, the two channels can be combined to create an interactively variable missing or extra bit.

**Video Signals:** Video signals are quickly changing today with all of the movement towards a new international standard for high resolution television. In addition, interactive compact disks and similar consumer video technologies are now requiring non-standard television signal formats which TV generators cannot provide with their standard cookbook of offerings. A dual channel AFG can produce the main structure of the video signal while placing the sync signals or other information on the second channel.

**Accurate Phase Control:** Digital synthesis of dual channel waveforms on a point-by-point basis allows the user to precisely adjust the phase relationship between two waveforms. By delaying one waveform by a single sample point with respect to the other waveform, a 1 MHz signal synthesized at 100 Mpoints/sec provides 1% resolution (3.6°).



## Channel Summing

Perhaps the most powerful feature afforded by the addition of a second channel is the ability to place one channel's output onto the other. In this fashion, two commonly-clocked channels can produce a composite output. Because the waveshapes produced by the two channels of an AFG can be independently programmed, this summing capability facilitates a variety of unique operating modes. Several examples are discussed below.

**Extended Dynamic Range:** Programming the gain of the summed channels to different values allows the AFG to produce large signals with small features on them. The programming resolution which can be achieved with this technique is greater than that which can be achieved with a single channel. The most common configuration for the dynamic range enhancement is demonstrated in Table 1.

TABLE 1

	CH1	CH2
Amplitude:	5V p-p	10 mV p-p
Filter:	10 MHz	100 MHz
Signal:	5 MHz sine	20 nsec pulse

In the configuration shown, the sine wave is produced with a 5 V swing. The purpose of the 10 MHz filter is to remove the sharp corners in the waveform resulting from the discrete DAC steps in the programmed waveform. The spike produced in Channel 2 is 500X smaller than the sine wave upon which it is superimposed. Because of the ratio of the gains programmed for the two channels, the resolution of the glitch is as high as the resolution of the sine wave.

## Adjustable Feature Size

By using the two-channel summed mode, a waveform can be loaded into Channel 1 with an anomaly loaded into Channel 2. Then, by varying the gain of Channel 2, the amplitude of the anomaly can be adjusted without changing the signal size. This feature is a powerful tool for studying the immunity of a variety of circuits to unwanted phenomena. Several examples are given below:

**Bit Dropouts on Magnetic Disks:** The signal which appears at the output of a head of a magnetic disk is called a Lorentzian and is represented by the equation:

$$V(t) = \sin(\omega t) - (1/3) \sin(\omega t/3) + (1/5) \sin(\omega t/5)$$

In order to simulate a bit dropout, one half of a cycle is truncated from the Channel 1 waveform and transferred to Channel 2. By adding the two waveforms, a normal Lorentzian waveform is obtained. (See Figure 7A next page). By decreasing the gain of Channel 2, the amplitude of the single cycle is decreased. (See Figure 7B). By adjusting the size of the bit under test, the sensitivity of the decoding electronics to signal amplitude can be studied.

**Sensitivity to Undershoot:** A digital pulse can be represented by an exponential rise

$$V(t) = (1 - \exp^{-t/T})$$

with a similar trailing edge. Multiple cycles of such a waveform were loaded into Channel 1 with a damped sinusoid in Channel 2. (See Figure 8A - next page). The sum of these signals is shown in Figures 8B and 8C (next page), with a low gain and high gain respectively. Thus, by varying the amplitude of the glitch on Channel 2, the magnitude of the undershoot can be adjusted, thereby allowing the user to study the immunity of a digital circuit to the occurrence.



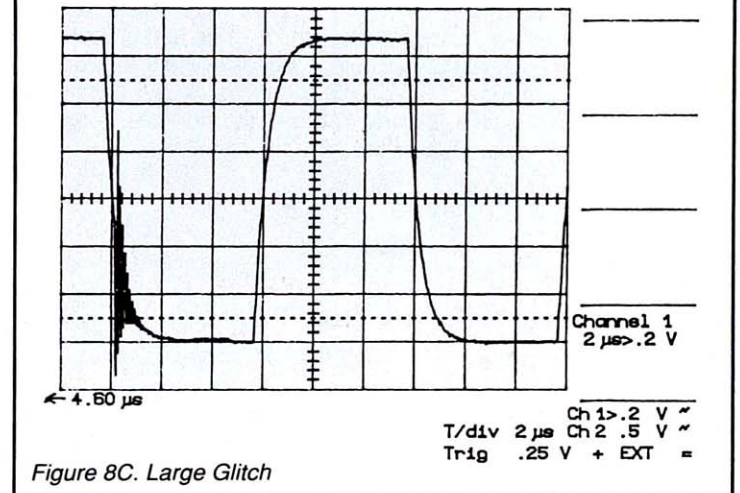
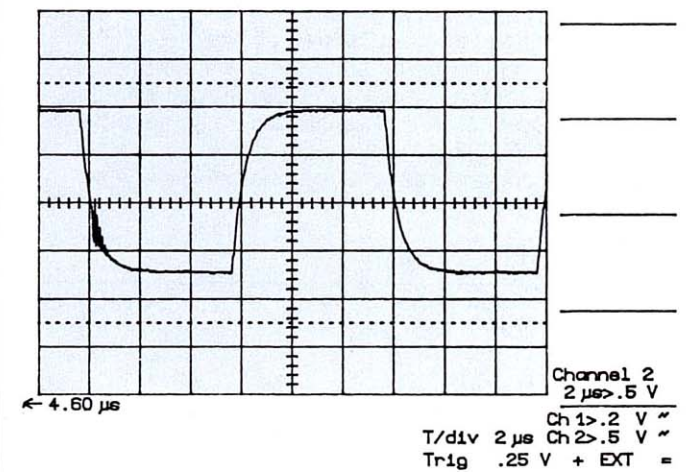
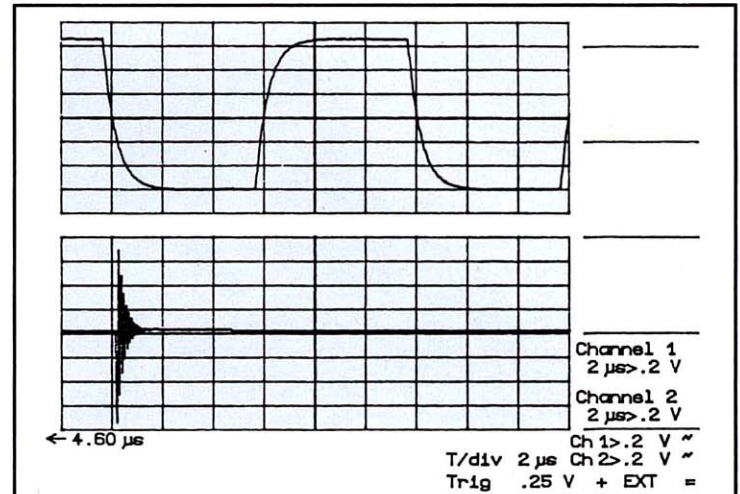
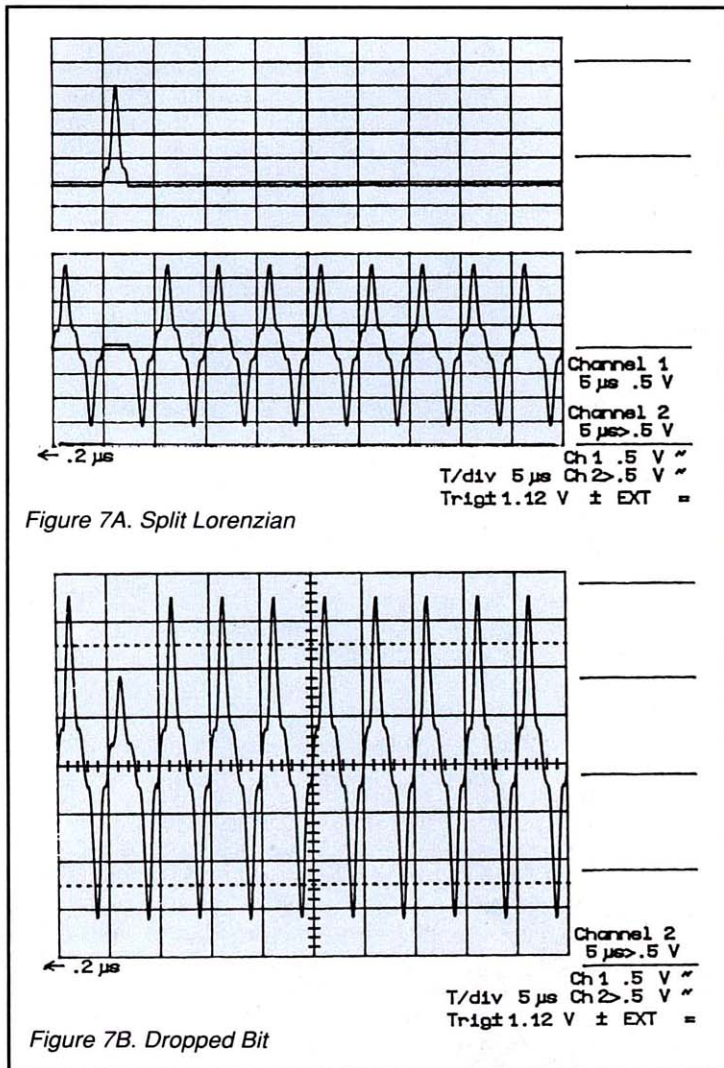



## RECURRENCE PROGRAMMING

Arbitrary Function Generators have a memory depth of a few thousand samples to as much as 512K samples. Long AFG memory allows an AFG to produce a waveform which is of long duration and at the same time has high frequency components. In contrast, conventional function generators can be made to produce long waveforms, but typically only at the expense of bandwidth. Many waveforms are repetitive or piecewise repetitive. When this is true, the AFG can be made to produce waveforms made up of more sample points than would be possible using the memory of the instrument directly.

### Linking

A feature which adds to the utility of the AFG by increasing the effective amount of memory is linking. This facilitates storing a variety of waveforms in segments of the AFG's memory and playing them back as an executable list. Most AFG's produce no gap between the waveforms. Because a waveform can be called up more than once, the operation of linking provides for rather long complex waveforms. An example of such a linked waveform is shown in Figure 9.

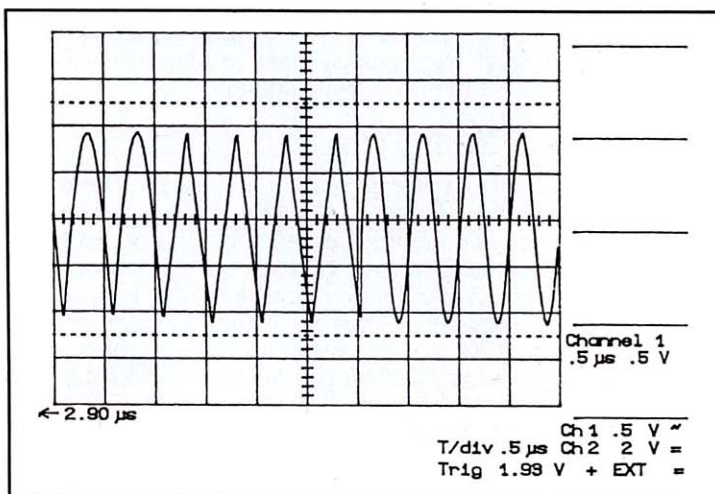

Figure 9. Linking Waveforms

### Looping

The most obvious way to extend the useful memory of the AFG is by looping. Many AFG's provide a loop counter to allow a given waveform to be repeated a programmable number of times. This allows a fixed number of waveforms to be produced each time the AFG is triggered.

### Looping and Linking

The strength of the recurrence programming feature is best demonstrated by the combination of looping and linking. Combining these features allows the AFG user to produce the longest and most complex waveforms. Several examples are given below.

**Bit Error Rate Testing:** A variety of schemes is used for encoding digital data, for example, frequency shift keying. In a system such as this, the chances for errors is great and testing must be done. A comprehensive test can be done through looping and linking a series of 256 waveforms together corresponding to  $2^8$ , or 256 bytes. An AFG can produce a long repeat cycle of bits with a random pattern. Then, an AFG auto-programming feature called a sequence file can be used to automatically execute this series of waveforms. A sequence file is similar to a computer command file or batch file and can reside within the AFG, ready for execution. A typical sequence file is shown in Figure 10.

```

LeCROY EASYWAVE SOFTWARE

SEQUENCE FILE EDITING

LOAD, BYTE0, 2;
LINK, BYTE1, 1;
LINK, BYTE, 3;
LINK, BYTE253, 100;
LINK, BYTE254, 50;
LINK, BYTE255, 5;
GO;
END;
    
```

Figure 10. Sequence File



## Evaluating Specifications

### ARCHITECTURE

Because of the newness of the AFG in the T&M marketplace, many different instrument architectures have emerged. Some are front-panel oriented, others are computer oriented. Some AFG's provide the ability to calculate waveforms from equations using an internal microcomputer. Others provide non-volatile storage of many waveforms which must be calculated by an external computer. Each has advantages. The former allows the AFG to stand alone, but the other provides faster execution without the need to recalculate each time. Still other AFG's require a computer to download waveforms each time they are needed. These are the simplest and lowest cost units but they sacrifice utility. A few AFG's provide front panels or keypads to facilitate standalone operation, while others are best controlled from a computer. There are even AFG's which do both.

Is your AFG needed for an ATE system application or is it a benchtop stand alone need? Stand alone units with either a keypad or front panel can provide some rudimentary arbitrary waveform capability, but to obtain the full customizing power of an AFG, a computer controller is generally required.

A second architectural aspect to consider is the number of channels. As described above, the multichannel unit provides a number of advantages especially if channel summing is also provided.

Another feature which is often provided is a digital word output. The same digital words which are applied to the DAC can be applied to a front panel connector as TTL or ECL levels. This provides a variety of digital testing opportunities in D/A or A/D testing as well as digital filters or radar applications.

### RESOLUTION OR SPEED?

Currently, AFG's offer either high resolution or fast sample rates. There are AFG's which incorporate 12-bit vertical resolution but at the expense of clock speed, while other possess much higher speeds at 8-bits. Generally, the choice must be made between higher bits or speed.

There are digital-to-analog converters commercially available today with output rates beyond several hundred MHz. Some gallium arsenide devices offer sample rates in the GHz range. The state-of-the-art is changing rapidly.

### TIMEBASE

The most obvious timebase specification is the maximum clock rate. This specification determines the applications for which the AFG is useful. For example, a 100 Kpoint/sec unit finds use in test of medical instruments such as EKG machines, whereas a 200 Mpoint/sec unit can be used for high speed applications such as radar.

A second parameter related to the timebase is called clock "settability". Many AFG's use phase-locked loop circuitry. The method in which the local oscillator frequency is programmed determines the ability of the generator to achieve a particular frequency. Some AFG's can set frequencies to 3 or even 4 significant digits, others can specify to two digits. Some AFG's only allow frequency programmed in factors of two. This difference can be important for some applications. For example, one might be settable to 99.99 Mpoints/sec as differentiated from 100 Mpoints/sec, but nowhere in between. The advantage of the simpler clock circuit is cost. Also, in some designs the accuracy and jitter of the more settable clock circuit suffer and provide less analog performance. In either case, the clock frequency is typically derived from a crystal standard and thus is highly accurate.

### HOW MUCH AFG MEMORY?

What is the longest waveform duration at maximum time precision an AFG can provide? The AFG maximum output speed and memory depth provide the answer. For instance, a 1 Kpoint memory length clocked at 20 nsec per point would generate a maximum of 20  $\mu$ sec of a waveform. This might be fine for transient analysis, but not ideal for functional testing. Obviously, the solution involves having a much longer memory length. AFG's today run from 1 Kpoint up to 512 Kpoints of memory. Depending on the application, this long memory might or might not be needed. Look for the features you need.



The AFG is memory intensive. Furthermore, it has several forms of memory. The memory specifications for each section include both the amount of memory and the availability of battery backup.

## Storage Memory

A moderate speed memory is used to store files which may be called for playback. Practicality dictates that this memory must be of a non-volatile nature. Many AFG's have no storage memory (RAM disk), so if your application requires the use of many different waveforms, and you do not have a computer or do not want to execute a series of keystrokes, be sure to choose a unit with this feature.

## Active Memory

Sometimes called the high-speed memory, this memory contains the waveform segments being executed. The importance of non-volatile active memory is important only for architectures without Storage Memory. AFG's are available with active memory sizes up to 512 Kpoints.

## Sequence Memory

The memory sequencer can be used to program looping and linking. The length of this memory determines the longest sequence of looping/linking operations which can be performed. Some AFG's also use this memory to insert pauses and to reset operating parameters such as amplitude setting.

## ANALOG PERFORMANCE

Perhaps the greatest number of specifications of an AFG pertain to the analog performance of the circuit. The DAC, amplifier/attenuator and filter circuits all effect the analog performance of the unit.

## Output Swing

Most AFG's are designed to drive 50 Ohms. Some can produce an output swing of one-to-two volts p-p and others provide greater than 20 V p-p. The specifications, however, may be written for driving 50 Ohm load or for a high impedance.

## Bits

The number of bits is a measure of the range of amplitude programmability. The resolution increases dramatically with the number of bits:

BITS	RESOLUTION
6	63
8	255
10	1023
12	4095

In general, the fastest AFG's have fewer bits than the lower speed units. Specifications regarding units with a summing mode may also quote the amount the performance (in effective bits) can be extended by summing. Also, when evaluating the performance of an AFG, compare the number of bits with the overall performance specifications (SNR and distortion specifications).

## Calibration Accuracy

The amplitude programming of an AFG is done using the amplifiers and attenuators in the signal conditioner section of the instrument. Precise amplitude resolution requires the use of several stages of amplifier and attenuator. This places great demands on the calibration accuracy of the AFG. As a consequence, some AFG's specify their amplitude accuracy only at full scale.

## Settling Time, Overshoot and Frequency Response

An arbitrary waveshape can take virtually any form. By virtue of its design, a good AFG should attempt to provide this complete flexibility. To achieve it, an AFG's output signal should be capable of swinging quickly from baseline to full amplitude in only one data point with a minimum of overshoot or ringing. In addition, the settling time it takes to arrive back at the final amplitude should be minimized.



Most AFG manufacturers specify their data point settling time and overshoot. These specifications are the true measure of a custom waveform generator. To accomplish this, AFG designers must make some trade-offs. Owing to the quantity of digital circuitry of the AFG, there is always the possibility of noise up to the clock frequency. Minimizing this noise is sometimes done by limiting the frequency response of the instrument. This is accomplished by placing a filter in the output path of the AFG. In the end this gives the best noise performance. A sharp roll-off will give the best noise performance, but only at the expense of introducing overshoot and ringing. Such a configuration does not faithfully produce high-speed edges like logic pulses and is optimal only for sine waves. If your application involves sine waves, such an instrument will do well. If not, be certain to check the overshoot specification as well as the data point settling time numbers.

## Noise

Noise comes from a variety of sources including that inherent to the output stage, the power supplies and other design factors. Also important, is the noise which originates from clock pickup.

Typically, the noise is specified in dBc (decibels below the carrier). It should be specified for operation without any of the output filters selected. In particular, when selecting an AFG, always make certain that the noise specifications make sense with regard to the number of bits of dynamic range specified. For example, with each bit corresponding to 6 dBc [i.e.,  $20\text{LOG}_{10}(2)$ ], 12 bits would correspond to a dynamic range of 72 dB.

## Distortion

When investigating the distortion specifications of an AFG, it is important to take into account the digital nature of the instrument. For instance, at higher frequencies there is even less resolution per cycle of a sine wave, therefore, the signal's energy is transferred to the harmonics. The distortion specs are normally given in dBc per frequency by the manufacturer and involve total harmonic distortion, spurious and non-harmonic distortion and intermodulation distortion.

## SOFTWARE SUPPORT

The availability of waveform creation software is an important plus for any AFG. The software must also allow for control of the instrument. Also important is the selection of computers for which the software has been written. Dedicated AFG software packages with sophisticated waveform entry and editing capabilities are available for ATE configurations. In addition, the software package normally makes it possible to combine an AFG and either a digital oscilloscope or digitizer together to form waveform workstation. This can be very useful for characterizing systems with stimulus/response. (Figure 11.)

## Conclusion

The AFG is a new class of instrument which uniquely satisfies a wide variety of applications. In R&D, it allows the designer to better understand his circuit's performance under real world conditions. In ATE, the AFG allows much more realistic testing of a product without expensive design of custom testers. As more experience is gained with this new instrument, exciting new uses continue to develop.

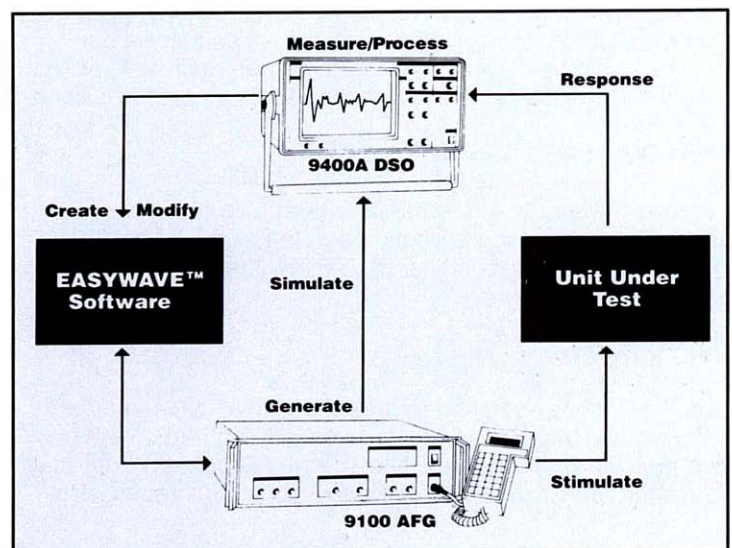

Figure 11. Stimulus/Response Testing



# Understanding Effective Bits

The accuracy and precision of a digitizer system is influenced by its analog to digital converter (ADC) and all of the signal processing components that support it. These include the analog signal conditioning, the sample-and-hold circuit and the stability of the time base.

While the performance of each of these elements can be assessed and specified individually, what is really needed is an overall measure of *system* performance. This is provided by a digitizer's "Effective Bits" specification. In essence, all system frailties are reflected as a "de-rating" of the ADC.

A system's effective bits will invariably be fewer than the number of physical bits in the ADC. In general, effective rather than physical bits define the *useable dynamic range* of a system.

## ADC QUANTIZATION ERROR

Even an ideal analog to digital converter produces errors due to quantization. The level of such error decreases with the number of bits employed. To appreciate this, consider the

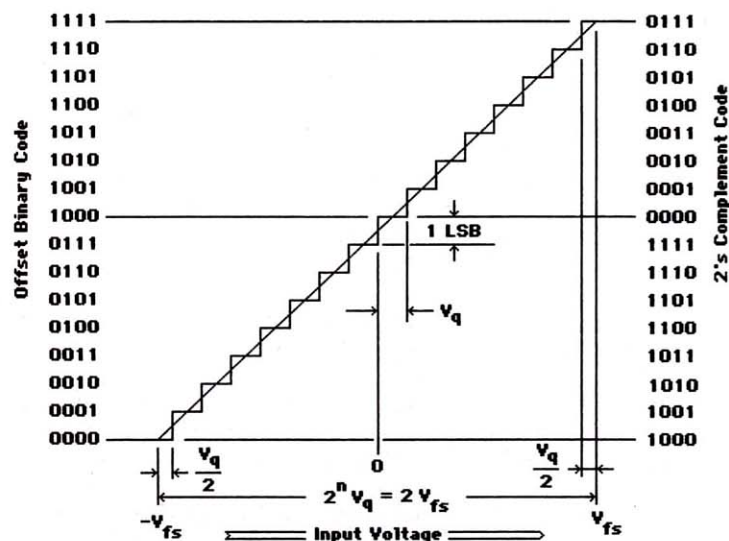

transfer characteristic of a four bit converter shown below. A perfect "n bit" converter exhibits  $2^n$  unique output codes uniformly spanning its  $\pm V_{fs}$  input voltage range. Each "least significant bit" (LSB) change of the output code reflects a change in input voltage by an amount,  $V_q$ , termed the "quantization voltage". Hence the code representation is exactly correct at only  $2^n$  specific voltages. In all other cases, it can represent an error of as much as  $\pm V_q/2$ . Hence the converter is said to be precise to  $\pm 1/2$  LSB.

Each output code thus represents a voltage span of  $\pm V_q/2$ . Normally, the quantization voltage is selected such that  $V_q = V_{fs}/2^{n-1}$ , where  $2^{n-1}$  represents the number of 'gaps' between actual codes. This preserves the  $\pm V_q/2$  spacing to the code extremes rendering the extreme codes meaningful (if external overload detection is employed). Such placement is presumed for the remainder of this discussion although it is noted that a "narrower" placement of  $V_q = V_{fs}/(2^{n-1}-1/2)$  may be used if the extreme codes merely serve as over-range detectors.

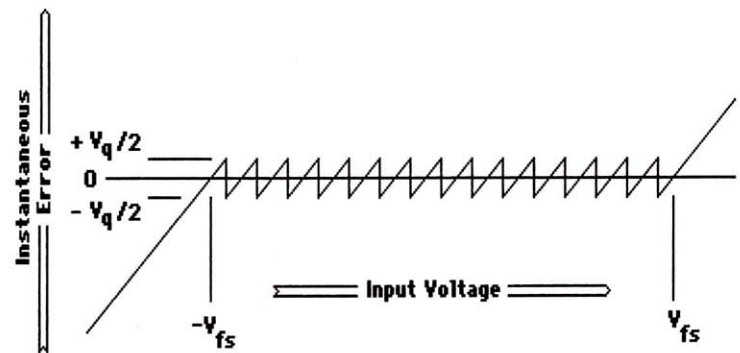

As may be seen in the figure above, the instantaneous disparity between the analog input and its code defined quantized approximation is bounded between  $\pm V_q/2$  for any input within the  $\pm V_{fs}$  range. When a dynamic signal is applied to the converter, any instantaneous error within this span is equally probable, regardless of the input signal's form. Hence, the quantization error may be characterized by a uniform Probability Density Function (PDF), as follows.



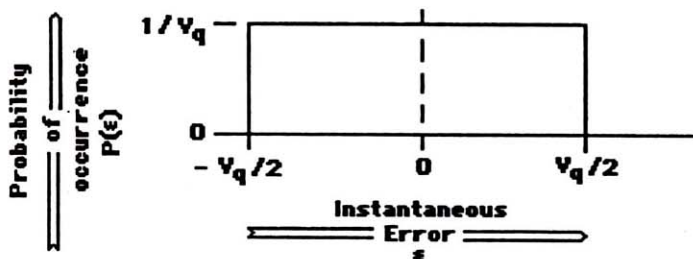

Clearly, the “mean” error or central error value is zero. Less obvious is the “mean square” (variance plus mean<sup>2</sup>) which may be derived as the second moment of the PDF, specifically:

$$\Psi^2 = \text{Mean Square Error} = \int_{-\infty}^{\infty} \epsilon^2 p(\epsilon) d\epsilon = \int_{-V_q/2}^{V_q/2} \frac{\epsilon^2}{V_q} d\epsilon = V_q^2/12$$

## THE SPECTRAL CHARACTERISTIC OF QUANTIZATION NOISE

An analog to digital converter is clocked at a fixed sample rate,  $f_s$ . Each converted code contains an error, a sample of the instantaneous quantization. Since the data contains no additional information until the arrival of the next sample, we may consider this digital error to be constant over the interval  $1/f_s$ . Each digital error is a sample from the uniformly distributed probability density function shown above.

Thus a digital “error signal” may be visualized as a stream of uniform width, random height pulses as shown below. The amplitude of the error signal is bounded by  $\pm V_q$ , and the random pulse height is updated at intervals of  $1/f_s$ .

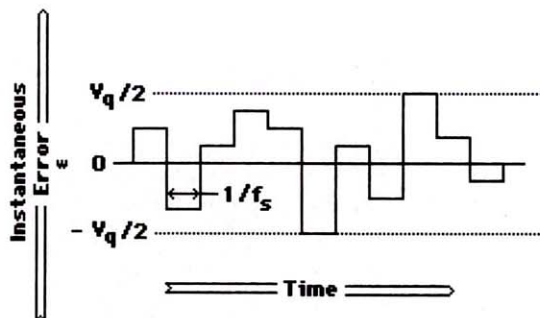

Clearly, the error at any given instant is independent of that at prior or following samples provided the input signal is dynamic. That is, the individual error samples are statistically unrelated; they are uncorrelated.

Hence we recognize that the Autocorrelation Function (ACF) describing the error must decay to the square of the mean error,  $\mu = 0$ , at a lag time equal to the intersample interval. We also know that the peak value of this function will occur at lag time equal to zero and that its amplitude will equal the mean-square,  $\Psi^2$ .

Between these extremes, the ACF will merely reflect the averaged correlation of each sample with itself, decaying with increasing lag time. The nature of this decay must be linear, owing to the rectangular form of each error pulse. Thus the ACF has the following form.

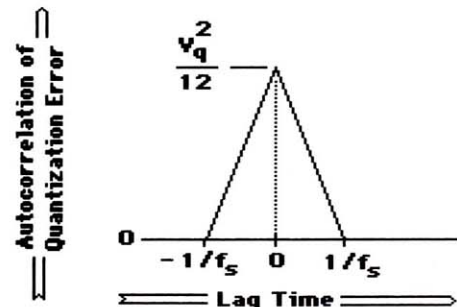

The Power Spectral Density (PSD) of the quantization error may be derived by Fourier transformation of the ACF in accordance with the well known Wiener- Khinchin theorem. This results in the spectral form shown in the next figure.

The PSD is the frequency derivative of the signal's mean-square. Hence the area under this curve is equal to  $\Psi^2$ . The actual spectral shape of the quantization noise is  $\sin^2(x)/x^2$  distributed with nodes at each harmonic of the sample rate. As may be seen in the next (linear-linear) figure, the bulk of the signal's power lies in the first lobe.

We deal here with a temporally sampled system. Any attempt to compute the error signal's frequency content *from the samples* will invariably result in a spectrum bounded by DC and  $f_s/2$ , the Nyquist frequency. That is we will detect an “aliased” image of the  $\sin^2(x)/x^2$  spectrum.



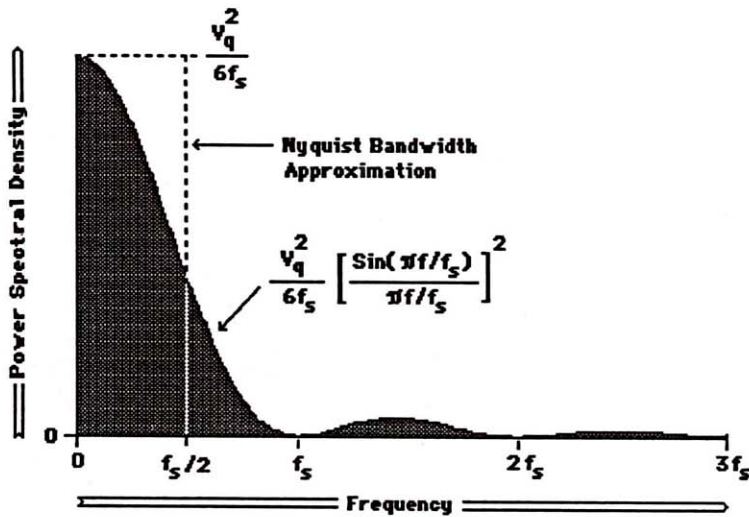

As a matter of practicality, we need to “fold” this spectrum so that the signal’s total power is expressed between DC and the nyquist frequency. The resulting aliased spectrum is closely approximated by a constant power per unit bandwidth of  $V_q^2/6f_s$  volt<sup>2</sup> per Hertz.

We gain several insights from this analysis. Firstly, the (mathematically detectable) spectral distribution of quantization noise is essentially equal from DC to the nyquist frequency. Secondly, while the total quantization mean-square is (theoretically) independent of sample rate, its power spectral density is inversely proportional to the sampling speed. Thirdly, both  $\Psi^2$  and its PSD amplitude decrease with increasing converter bits. Fourthly, these levels are a fixed fraction of the input range ( $\pm V_{fs}$ ) and are not a function of input signal level.

**SIGNAL-TO-NOISE RATIO**

It is desirable to have simple means of describing a digitizer’s quality. Modern approaches to this description have been developed utilizing the concept of “root mean-square” (RMS) error. From the preceding, the RMS quantization error of an “ideal” converter may be stated.

$$\Psi = \text{RMS Quan. Error} = \frac{V_q}{\sqrt{12}} = \frac{\sqrt{3}}{6} V_q \cong 0.289V_q$$

This RMS error is often compared against an analog input sinusoid of the form:

$$\text{“Full-Scale” Sinusoid} = V_{fs} \sin(2\pi ft) = 2^{(n-1)} V_q \sin(2\pi ft)$$

The RMS value of such a full-scale signal is:

$$V_{\text{RMS}} = \frac{\sqrt{2}}{2} V_{fs} = \frac{\sqrt{2}}{2} 2^{n-1} V_q = \frac{\sqrt{2}}{4} 2^n V_q$$

So that the maximum “signal to noise ratio” (S/N) for an “ideal” digitizer may be stated:

$$S/N_{\text{ideal}} = V_{\text{RMS}}/\Psi = \frac{3\sqrt{2}}{2\sqrt{3}} 2^n \cong 1.225 * 2^{(n)}$$

This ratio is often expressed in decibels (dB) in accordance with:

$$\text{dB}(S/N_{\text{ideal}}) = 20 \log_{10}(1.225 * 2^{(n)}) \cong (1.761 + 6.021n) \text{ dB}$$

Several observations can be made with regard to these relationships. Firstly, The actual noise exhibited by a real digitizing system will invariably exceed the quantization noise,  $\Psi$ , of an “ideal” converter. Hence, the measurable S/N ratio always will be less than  $1.225 \times 2^n$  for an “n-bit” converter. Secondly, the *ratio* of this noise to the signal input stimulating it will *increase* with signal level and signal frequency. These effects reflect properties of the analog circuitry supporting the ADC as well as those of the actual converter. Thirdly, more resolute converters exhibit lower quantization noise with a rate of improvement of  $\approx 6$  dB per bit.

**EFFECTIVE BITS CHARACTERIZATION**

The practical evaluation of digitizers hinges upon expressing the RMS noise,  $\Psi_{\text{act}}$ , actually exhibited by the converter as a multiple of the quantization noise,  $\Psi$ , of an “ideal” converter. This multiple is commonly expressed as a binary exponential of the form ...

$$\Psi_{\text{act}} = 2^{(L)} \Psi ; L = \text{“lost bits”}$$

The exponent, L, is termed a measure of “lost bits”.



Rather than thinking of the the digitizer's performance in terms of RMS noise or S/N ratios, this allows the performance to be specified in terms of the remaining or "effective bits" of usable quantization. The IEEE has proposed the following definition of a converter's effective bits.

$$B_e = \text{Effective Bits} = \text{Actual Bits} - \text{Log}_2 \frac{\text{Actual RMS Quant. Error}}{\text{Ideal RMS Quant. Error}}$$

$$= n - \text{Log}_2(\Psi_{\text{act}}/\Psi)$$

The IEEE also proposed a means of measuring this characteristic and this has been generally accepted throughout the T&M industry. Although a rigid industry-standard testing specification has yet to be generated, most manufacturers have developed procedures that embrace the spirit of the IEEE proposal.

The IEEE proposed test signal is a sinewave of high spectral purity, stable frequency, low DC off-set and stable amplitude. The preferred signal source is the (analog) filtered output of a digital sinewave synthesizer. Digital synthesis provides frequency and amplitude stability; filtering the synthesizer's output with a band or low-pass filter provides the required spectral purity.

This signal is applied to the digitizer and a series of N samples are recorded to memory in a continuous sequence at sample rate,  $f_s = 1/\Delta t$ , without regard to any trigger condition. Each such sample,  $Y_i$ , is presumed to be the form:

$$Y_i = Y(i\Delta t) = \text{DC} + V \text{Sin}(2\pi f_i \Delta t + \theta) + \epsilon_i$$

That is, each sample is presumed to taken from a biased sinewave of fixed frequency, phase and amplitude. The ith is presumed to be in error by an amount,  $\epsilon_i$ . The N digital samples thus acquired are subjected to a mathematical "curve fitting" algorithm that identifies four parameters.

The curve-fit identifies the frequency, amplitude, and phase of the sinewave and the amount of DC off-set accompanying it. The algorithm is a "least squares" error minimization process that simultaneously detects the four parameters in such manner as to minimize the accumulated squared error,  $\Psi_{\text{act}}^2$ , where:

$$\Psi_{\text{act}}^2 = \sum_{i=0}^{N-1} \epsilon_i^2$$

This is accomplished by solving the non-linear set of equations that result from equating the first derivatives of  $\Psi_{\text{act}}^2$  with respect to V, f,  $\theta$  and DC to zero. While  $\Psi_{\text{act}}^2$  is not explicitly developed by the curve-fitter, it may be evaluated from the N samples,  $Y_i$ , and the four parameters returned from the fitting algorithm.

Thus the "fit error",  $\Psi_{\text{act}}$ , may be recognized as an RMS error akin to the "ideal" quantization noise,  $\Psi$ , but of invariably greater magnitude. This permits defining the digitizer's effective bits in accordance with:

$$B_e = n - \text{Log}_2(\Psi_{\text{act}}/\Psi)$$

At first glance, this procedure seems a little "loose" in that the amplitude, frequency and phase of the test signal are neither prescribed nor independently measured. In actuality, these are meritorious characteristics of the IEEE proposal. Note that no secondary measurement standards (with attendant traceability) are required to implement this procedure. All characteristics of the test signal are recovered solely from the digital samples taken by the digitizer.

The samples are acquired without regard to trigger timing; signal positioning (phase) is determined by the curve-fit. Hence, trigger circuit frailties do not influence the  $B_e$  computation. Since the frequency is also determined by the algorithm, the absolute accuracy of the sample clock is not influential. Clearly, the stability of the sample clock is tested.



Amplitude effects deserve special attention. Note that the RMS value of the test signal can be computed from the returned amplitude value, V. This allows the computation of the test's actual S/N ratio as:

$$S/N_{act} = \frac{\sqrt{2}V}{2\Psi_{act}}$$

While this statistic might simply be used in comparison with the "ideal" S/N ratio, it is more informative to use it algebraically to form an alternative and absolutely equivalent  $B_e$  statement. Specifically:

$$B_e = .166 [dB(S/N)_{act} - dB(V/V_{fs})] - .293$$

If the actual performance of the digitizer approximates "ideal" converter character,  $\Psi_{act}$  will be essentially independent of the signal level, V. Thus reducing the test signal's amplitude by X dB will decrease  $S/N_{act}$  by a like number of dB. But it will also decrease the ratio of the signal to the digitizer's full scale ( $V/V_{fs}$ ) by X dB and thus the two factors within the braces will cancel one another. In principle, then, the result should be independent of signal amplitude.

In point of fact, the "effective bits" definition was conceived as a means of qualifying a digitizer with a single number rather than a myriad of interrelated specifications. While this objective was noble, it has proven infeasible. Effective bits accurately convey a converter system's performance in a readily conceived manner, but this performance is not constant over the entire operational range for current technology digitizers.

Effective bits describe a measurement system's overall performance, not merely the behavior of a single component. The IEEE proposed procedure evaluates the entire "front end" of an acquisition system. Hence it reflects the performance of analog signal conditioning, the sample/hold circuitry preceding an ADC, the converter itself and the timing consistency of the clocking circuits. Each of these elements exhibit different frailties; some are signal dependent, others are frequency sensitive.

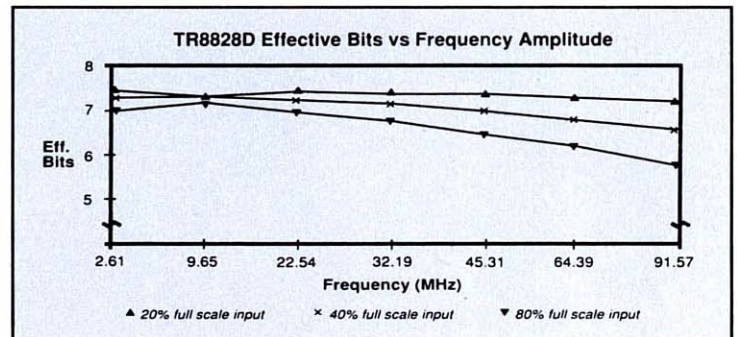

Effective bits accurately convey a digitizer's worth when they are evaluated over the range of the instrument's utility. In general, all current digitizers exhibit maximum effective bits when tested at low frequency with a signal of modest amplitude. As the test signal's frequency is increased, the effective bits fall off indicating a significant decrease in usable resolution. To a lesser extent, increasing signal amplitude also results in a loss of effective bits. Reputable digitizer manufacturers now characterize their products with families of effective bit verse frequency curves for varying amplitudes as shown above.



## Glossary of Technical Terms

**Acquisition Time:** In a sample-and-hold or track-and-hold circuit, the time required after the sample or track command for the output to slew through a full scale voltage change and settle to its final value to within a specified error band.

**ADC:** Analog-to-digital converter.

**Aliasing:** Whenever a dynamic signal is synchronously sampled, a possibility of misunderstanding its frequency content exists. This difficulty is termed "aliasing", and occurs whenever the sampling rate is less than twice the highest frequency component in the signal being measured. (See "Fundamentals of Aliasing" in Tutorial Section).

**AND:** Logical designation or circuit function meaning that all inputs must be in the TRUE state for a TRUE output.

**Aperture Jitter:** In a sample-and-hold or ADC, the jitter between the time of the sample (or convert) command pulse and the time the input signal is actually sampled. This jitter is usually due to thermal noise. It leads to an uncertainty in the sampled amplitude equal to  $\Delta t \, dV/dt$  where  $\Delta t$  is the aperture jitter, and  $dV/dt$  is the rate of change of the input voltage at the time of sampling. The terms aperture jitter and aperture uncertainty are often used interchangeably.

**Aperture Uncertainty:** In a sample-and-hold or ADC, the total uncertainty in the time of the sample (or convert) command pulse and the time the input signal is actually sampled, due to all causes including noise, signal amplitude dependent delay variation (as in a flash ADC), temperature, etc. Often used interchangeably with aperture jitter, but aperture uncertainty is the more inclusive term.

**Area:** In a time domain DSO waveform measurement, area is the sum of the sampled values between the cursors times the duration of a sample.

**Artifact Rejection:** Used in summation averaging to exclude waveforms which have exceeded the dynamic range of recording system.

**Automatic Gain Control:** A circuit that automatically adjusts the gain of a receiver to account for signal attenuation through the transmission media in order to create the desired range at the receiver output.

**Automatic Setup:** In an oscilloscope, automatic scaling of the time base, trigger, and sensitivity settings. Provides a stable display of repetitive input signals.

**Automatic Threshold Control:** A circuit that automatically adjusts the comparator threshold of a digital receiver to some fraction of the peak amplitude of the input signals.

**Average:** See Mean Value, Summation Averaging and Continuous Averaging.

**Bandwidth:** In normal use, the frequency range over which the gain of an amplifier or other circuit does not vary by more than 3 dB.

**Baseline Shift:** See DC LEVEL SHIFT.

**BCD:** Binary-coded decimal.

**BER:** See BIT ERROR RATE.

**Binning:** A technique for combining points in a histogram to be compatible with the resolution of the display device.

**Bit:** An abbreviation of "binary digit", one of the two numbers, 0 and 1, used to encode computer data. A bit is often expressed by a high or low electrical voltage.

**Bit Error Rate:** Ratio of the number of bits of a message incorrectly received to the total number received.

**Blanking:** Setting an output signal to its quiescent level for the duration of the blanking input signal. (Not the same as RESET).

**Bridged Outputs:** Parallel output connections which are internally tied common from one signal source.

**Byte:** A group of eight bits used to encode a single letter, number or symbol.

**Cascading:** Using units in series to augment a desired characteristic (e.g., amplification, number of inputs, etc.).

**CCD:** Charge Coupled Device. An integrated circuit which allows the transfer of a variable amount of charge through a series of cells; an analog shift register.



# Appendix A

**Channel:** 1. A path through an arrangement of components (modules and electrical and/or optical cabling) along which signals can be sent (e.g., a data channel, voice channel, etc.).

2. A path through a single module often containing many identical parallel paths (e.g., "12-channel amplifier" usually implies a module with 12 identical amplifiers).

3. A band of amplitudes, frequencies, or time domains, as when a general region of interest is divided into many small slices (also called bins). (For example, a multichannel analyzer is an instrument that accepts a train of signals and sorts them into their appropriate bins or channels.)

**NOTE:** in referring to ADCs, there is often confusion whether definition 2 or 3 applies. A 256 channel ADC may mean 256 independent ADCs in one module or may mean a single ADC with 256 ( $2^8$ ) amplitude bins or channels (usually referred to as 8-bit ADC).

**Channel Paralleling:** Analogous to paralleling outputs. Two or more channels give exactly the same output as a function of all the inputs to the given channels.

**Channel Profile:** A measure of intrinsic ADC or TDC noise, normally expressed as the nominal width at a defined height of the probability vs. input distribution of the channel.

**Charge Sensitive:** A device in which the output is directly proportional to the total integrated charge contained in the input pulse. A nominal integrating time must be specified.

**Clamping:** Holding a circuit point to some reference level (frequently ground) by means of a low-impedance element such as a saturated transistor, FET, forward-biased diode, relay, etc.

**Coherent Gain:** The normalized coherent gain of a filter corresponding to each window function is 1.0 (0 dB) for the Rectangular window and less than 1.0 for other windows. It defines the loss of signal energy due to the multiplication by the window function.

**Common Mode Range:** The maximum range (usually voltage) within which differential inputs can operate without a loss of accuracy.

**Common Mode Rejection Ratio:** The ratio of the common-mode input voltage to the output voltage expressed in dB. The extent to which a differential amplifier does not provide an output voltage when the same signal is applied to the both inputs.

**Common Mode Signal (Noise):** The signal (usually noise) which appears equally, and in phase on each of the differential signal conductors to ground. See DIFFERENTIAL INPUT.

**Complementary Output:** An output giving a signal with its quiescent state and TRUE state reversed from that of the normal output signal.

**Complementary Logic:** Using complementary logic pulses to simulate an anti-function. For example, if in a coincidence unit a complementary pulse is in time coincidence with other inputs, it will inhibit the action of the other inputs; in a veto input, a complementary pulse will act as an enable.

**Continuous Averaging:** Sometimes called exponential averaging the technique consists of the repeated addition, with unequal weight, of successive source waveforms. Each new waveform is added to the accumulated average according to the formula:

$$S(i,\text{new}) = N/(N+1) \times [S(i,\text{old}) + 1/(N+1) \times [W(i)]$$

where

i index over all data points of the waveforms

W(i) newly acquired waveform

S(i,old) old accumulated average

S(i,new) new accumulated average

N Weighting factor (1,3,7...)

**Control and Status Register (CSR):** A register used to control the operation of a device and/or record the status of an operation.

**Conversion Cycle:** Entire sequence involved in changing data from one form to another, e.g. digitizing an analog quantity, changing binary data to BCD, etc.

**Conversion Gain:** The slope of the function relating a converter output to the input, e.g., for a linear charge ADC with no pedestal, the conversion gain is the full-scale counts, divided by the full-scale input, probably in counts/pC. Note that this is the inverse of the sensitivity of the converter, but the terms are occasionally interchanged.

**Conversion Time:** The amount of time taken to measure an analog phenomenon (e.g., a time duration, peak waveform voltage, quantity of charge within a pulse, etc.) and have its digital representation ready for readout.

**Crosstalk:** Unwanted coupling of a signal from one channel to another.

**DAC:** Digital-to-analog converter.



**Data Logger:** An instrument which accepts input signals (usually slow analog), digitizes them, and stores the results in memory for later readout. The digital equivalent of a strip-chart recorder.

**DC:** Direct current. Normally means a voltage or current which remains constant.

**DC Level Shift:** A change in the nominal DC voltage level present in a circuit.

**DC Offset:** See DC LEVEL SHIFT. This term may imply that the shift is intentional, for example, adjustable per control knob.

**DC Overload:** An overload signal of long duration compared to the normal input pulse width or duty ratio of a circuit.

**Dead Time:** In a digital oscilloscope, the dead time is the time from the end of one acquisition of data to the start of the next acquisition.

**Decimation:** The process of reconstructing a source waveform with a reduced number of data points by only every Nth data point, where N is an integer.

**Differential Input:** A circuit with two inputs that is sensitive to the algebraic difference between the two.

**Differential Linearity:** A term often inappropriately used to mean differential non-linearity.

**Differential Non-Linearity:** 1. The percentage departure from the average of the slope of the plot of output versus input from the slope of a reference line.

2. The percentage of variation in ADCs or TDCs from the mean of the analog (or time) width of any single digital step. Usually measured by driving the input with a large number of random amplitude pulses and then measuring the relative number of events in each digital bin.

**Differential Output:** A circuit with two outputs supplying one normal and one complementary level of output signal.

**Differential Pulses:** Two opposite polarity pulses coincident in time.

**Dithering:** Typically used when averaging signals (which have low noise content) to improve vertical resolution and decrease the effects of an ADCs non-linearities. The technique applies different offsets to each incoming waveform to ensure the signal is not always digitized by the same portion of the ADC. The offsets must be subtracted from the recorded signals before being included in the summed average.

**Digital Filtering:** The manipulation of digital data to enhance desirable and remove undesirable aspects of the data.

**Double-Pulse Resolution:** The minimum input pair spacing at which a comparator responds properly to the second of a pair of pulses.

**DPR :** See DOUBLE-PULSE RESOLUTION.

**Duty Cycle:** A computed value in digital scopes, representing the average duration above midpoint value as a percentage of period for time domain waveforms.

**Dynamic Range:** The ratio of the largest to the smallest signal which can be accurately processed by a module.

**Dynamic RAM:** A random access memory in which the internal memory must be refreshed periodically.

**ECL:** Emitter-coupled logic, an unsaturated logic performed by emitter-coupled transistors. Normally, ECL LOGICAL 1 = -1.6 V and LOGICAL 0 = -0.8 V.

**EMI:** Electromagnetic interference caused by current or voltage induced into a signal conductor by an electromagnetic field in the conductor's environment.

**ENBW (Equivalent Noise Bandwidth):** For a filter associated with each frequency bin, ENBW is the bandwidth of an equivalent rectangular filter (having the same gain at the center frequency) which would collect the same power from a white noise signal.

**Equivalent Time Sampling (EQT):** Equivalent Time Sampling (EQT or sometimes ETS) is a means of exploiting the aliasing phenomenon to increase the usable bandwidth of a digitizer by making it appear to sample more rapidly than its maximum single shot sample rate. Works only with stable, repetitive signals. (See "Aliasing" Ap. Note in Technical Tutorial section).

**Extrema:** The computation of a waveform envelope, by repeated comparison of successive waveforms, of all maximum points (roof) and all minimum points (floor). Whenever a given data point of the new waveform exceeds the corresponding maximum value in the roof record, it is used to replace the previous value. Whenever a given data point of the new waveform is smaller than the corresponding floor value, it is used to replace the previous value.

**Falltime:** Unless otherwise defined, the time required for a pulse to go from 90% to 10% of full amplitude. Can also refer generally to the trailing edge of a pulse.

**Fan-in:** The mixing of more than one input to obtain one of the following outputs: 1. Linear — a circuit which linearly adds the amplitudes of more than one input signal and creates an output signal equal to the algebraic sum of the inputs; or 2. Logic — a circuit with more than one input which gives a logic output signal whenever a logical signal appears in any input (equivalent to a logical OR function.)



---

# Appendix A

---

**Fan-Out:** The reproduction of an input signal at more than one output.

**Fast Fourier Transform (FFT):** In signal processing applications, a Fast Fourier Transform is a mathematical algorithm which takes a discrete source waveform, defined over N points, and computes N complex Fourier coefficients, which are interpreted as harmonic components of the input signal. For a "real" source waveform (imaginary part equals 0), there are N/2 independent harmonic components.

**Feedthrough:** Unwanted signal which passes a closed gate, or disabled input.

**FFT:** See Fast Fourier Transform.

**FFT Frequency Bins:** A Fast Fourier Transform (FFT) corresponds to analyzing the input signal with a bank of N/2 filters, all having the same phase and width, and centered at N/2

components such as CCD's) used in a common circuit, or to perform waveform integration, differentiation, or smoothing, just to name a few types.

**Flash ADC:** A very fast analog-to-digital converter in which the analog signal simultaneously is compared to  $2^n - 1$  different reference voltages, where n is the ADC resolution. Also called a parallel converter. A very fast analog-to-digital converter usually consisting of a large set of fast comparators and associated logic.

**Floor:** The record of points which make the bottom (or minimum) of an envelope created from a succession of waveforms.

**FWHM:** Full-Width Half Maximum. The width of a pulse or waveform at 50% amplitude used to measure the duration of a signal. Used to measure the duration of a signal.



**IC:** Integrated Circuit. A self-contained multiple element circuit such as a monolithic or hybrid.

**Importance Sampling:** Increasing the sample rate during certain periods of recording to obtain denser sampling information. (A technique often used with transient recorders to optimize use of memory areas).

**Inhibit:** A signal or switch which prevents a unit from operating or responding to inputs; also called VETO in fast logic.

**Integral Linearity:** A term often used inappropriately to mean integral non-linearity.

**Integral Non-Linearity:** Deviation of ADC response from an appropriate straight line fit. The specification is sometimes defined as maximum deviation expressed as a fraction of full scale. More recent ADCs have a specification expressed as a percent of reading plus a constant.

**Interchannel Dead Time:** The time required to switch from one circuit path to another.

**Interleaved Clocking:** Supplying clock pulses of equal frequency but different identical circuits or instruments in order to increase the system sample rate. For example, use of two transient recorders with inputs in parallel but complementary clocks to allow operation at twice the maximum rate of a single unit.

**Interval Trigger:** Selects an interval between two edges of the same slope. The trigger can be generated on the second edge if it occurs *within* the selected interval (interval ) or *after* the selected interval (interval ). The timing for the interval is initialized and restarted whenever the selected edge occurs.

**Jitter:** Short-term fluctuations in the output of a circuit or instrument which are independent of the input.

**Leading-Edge Inhibit:** Only the leading edge of the input must be overlapped by an "inhibit pulse" to prevent response of the unit.

**Leakage:** When observing the Power Spectrum of a sine wave having an integral number of periods in the time window using the Rectangular Window, leakage is the broadening of the base of the peak spectral component that accurately represents the source waveform's amplitude.

**LED:** Light Emitting Diode.

**Limiter:** A circuit element which limits the amplitude of an input (used for input protection, pulse standardizing, etc.).

**Logical 1:** A signal level indicating the TRUE state; corresponds to the unit being set (i.e. if interrogated, the answer is yes).

**Logical 0:** A signal level indicating the FALSE state; corresponds to the unit NOT being set (i.e. if interrogated, the answer is no).

**Long-Term Stability:** Refers to stability over a long time, such as several days or months.

**Mass Terminate:** The ability to attach a single multipin connector to multiconductor ribbon cable or coax.

**MCA:** Multichannel Analyzer (e.g., pulse height analyzer).

**Mean Value:** Average or DC level of all data points selected in a waveform. i.e.,

$$\frac{1}{N} \sum_{i=1}^N V_i$$

**Median Value:** The data value of a waveform above and below which there are an equal number of data points.

**Mode Value:** The most frequently occurring data value of a waveform.

**Monolithic IC:** An integrated circuit whose elements (transistors, diodes, resistors, small capacitors, etc.) are formed in situ upon or within a semiconductor substrate.

**Monostable Multivibrator:** A circuit which, if triggered into its unstable state, will return after a preset length of time. (Also called a monovibrator or a univibrator).

**Monotonic:** A function with a derivative that does not change sign.

**Multiple Pulsing:** More than one serial output from a single input.

**Multiplexer:** A device used to selectively switch a number of signal paths to one input or output.

**NAND:** An AND circuit, except with a complementary (negative true) output.

**Negation:** The process of transposing all negative values into positives and all positive values into negatives.

**Noise Equivalent Power:** NEP (W); the rms value of optical power which is required to produce unity rms signal-to-noise ratio.

**NOR:** An OR circuit, except with a complementary (negative true) output.

**NRZ:** Non-return to zero. A serial data format in which successive bits are not separated by a momentary return to the zero state.



# Appendix A

**Nyquist Frequency:** The Nyquist frequency ( $f/2$ ) is the maximum frequency that can be accurately measured by a digitizer sampling at a rate of ( $f$ ). In other terms, a digitizer sampling at a rate of ( $f$ ) cannot measure an input signal with bandwidth components exceeding  $f/2$  without experiencing "aliasing" inaccuracies. (See "Aliasing" Ap. Note in Tutorial Section).

**Offset:** The amount by which an analog or digital output or input baseline is shifted with respect to a specific reference value (usually zero).

**OR:** A logic circuit having the property that if at least one input is true, the output is true.

**Overshoot, Negative:** A time domain parameter in waveform measurements, equal to the base value of a waveform minus the minimum sample value, expressed as a percentage of the amplitude.

**Overshoot, Positive:** A time domain parameter in waveform measurements, equal to the maximum sample value minus the top value, expressed as a percentage of the amplitude. The top value is the most probable state determined from a statistical distribution of data point values in the waveform.

**Parallel Converter:** A technique for analog-to-digital conversion in which the analog signal is simultaneously compared to  $2^n - 1$  different reference voltages, where  $n$  is the ADC resolution.

**Pattern Trigger:** The pattern trigger logically combines the states of the trigger inputs. The combination, called a pattern, is defined as the logical AND of the trigger states. A trigger state is either high or low; high when a trigger source is greater than the trigger level and low if it is less than the trigger level. For example, the pattern can be defined as present when the trigger state for channel 1 is high, 2 is low, and EXT is high. If any are not met, the pattern state is considered absent.

**Pattern Width:** Selects a pattern width, either maximum or minimum. If the width is less than the selected width, the trigger is generated when the pattern ends. If the width is greater than the selected width, the trigger is generated when the pattern ends. The timing for the pattern width is initialized and restarted at the beginning of the pattern.

**Peak Spectral Amplitude:** Amplitude of the largest frequency component in a waveform in frequency domain analysis.

**Peak Sensing ADC:** An analog-to-digital converter which measures only peaks of waveforms occurring within the measurement period.

**Pedestal:** The response of a digitizing circuit (in counts or input units) when gated with no input signal applied. The value normally depends upon the gate width. For charge digitizers, the relation is generally linear and corresponds to an input offset current.

**Period:** A full period is the time measured between the first and third 50% crossing points (mesial points) of a cyclic waveform.

**PHA:** Pulse Height Analyzer. A device that gives a measure of the amplitude of a signal applied to its input.

**Picket Fence Effect:** If a sine wave has a whole number of periods in the time domain record, the Power Spectrum obtained with the Rectangular window will have a sharp peak, corresponding exactly to the frequency and amplitude of the sine wave. If it does not, the spectrum obtained will be lower and broader. The highest point in the power spectrum can be 3.92 dB lower (1.57 times) when the source frequency is halfway between two discrete bin frequencies. This variation of the spectrum magnitude is called the Picket Fence Effect (the loss is called the Scallop Loss). All window functions compensate this loss to some extent, but the best compensation is obtained with the Flat Top window.

**PISO:** Parallel-In, Serial-Out shift register.

**Post-Trigger Sampling:** A design concept frequently used in transient recording in which sampling continues after assertion of a stop trigger for a predetermined interval.

**Power Spectrum:** The Power Spectrum ( $V^2$ ) is the square of the Magnitude spectrum. The Power Spectrum is displayed on the dBm scale, with 0 dBm corresponding to  $V_{ref}^2 = (0.316 V_{peak})^2$ , where  $V_{ref}$  is the peak value of the sinusoidal voltage which is equivalent to 1 mW into 50  $\Omega$ .

**Power Density Spectrum:** The Power Density Spectrum ( $V^2/Hz$ ) is the Power Spectrum divided by the equivalent noise bandwidth of the filter, in Hz. The Power Density spectrum is displayed on the dBm scale, with 0 dBm corresponding to  $(V_{ref}^2/Hz)$ .

**Pretrigger Sampling:** A design concept used in transient recording in which a predetermined number of samples taken before a stop trigger are preserved.

**PROM:** Programmable read-only memory. An integrated circuit memory array that is made with a pattern of either all logical zeros or ones and has a pattern written into it by the user with a special hardware program.

**Pulse Width:** Determines the duration between the Pulse Start (mesial point, i.e. the 50% magnitude transition point, on the leading edge) and the Pulse Stop (mesial point on the trailing edge) of a pulse waveform.



**Pulse Start:** The 50% magnitude transition point (mesial point) on the leading edge of a pulse waveform.

**Pulse Stop:** The 50% magnitude transition point (mesial point) on the trailing edge of a pulse waveform.

**Pulse Trigger:** Selects a pulse width, either maximum or minimum. The trigger is generated on the selected edge when the pulse width is either greater than or less than the selected width. The timing for the width is initialized and restarted on the edge opposite to the edge selected.

**Quasi-Differential:** An input which accepts single-ended signals, yet its isolated ground return offers common mode rejection properties similar to a fully differential input. In general, the common mode rejection is effective only for low frequencies.

**RAM:** A memory in which each data address can either be written into or read from at any time.

**Random Interleaved Sampling (RIS):** Random Interleaved Sampling is one method of Equivalent Time Sampling. Acting upon stable, repetitive signals, it represents the process of storing different full sampling sweeps in a DSO or digitizer system, where each sweep is slightly offset from the other to achieve a higher effective sampling rate than the single shot rate. A major advantage of RIS over other EQT (ETS) techniques is "pretrigger viewing." (See "Aliasing" Ap. Note in Technical Tutorial section).

**Real Time:** A process that occurs without having to pause for internal conversions and references. Real time processes usually have little or no intrinsic deadtime and are able to proceed at a rate which permits almost simultaneous transitions from inputs to outputs.

**Reciprocal:** The division of unity by the data value being processed.

**Reflection Coefficient:** The amount of signal amplitude that is reflected from an input, expressed as a percentage of the original input signal.

**Resolution:** The minimum measurable increment, as one bit level of an ADC.

**Reverse Termination:** An output so constructed that pulses reflected back from the rest of the system meet a matching impedance and are absorbed.

**RF:** Radio Frequency. Normally in the megahertz range.

**RFI:** Radio Frequency Interference. A special case of EMI wherein the field causing the induced signal falls into the radio portion of the electromagnetic spectrum.

**Risetime:** Unless otherwise defined, the time required for a pulse to go from 10% to 90% of full amplitude. Can also refer generally to the leading edge of a pulse.

**RMS:** Is derived from the square root of the average of the squares of the magnitudes, for all the data as described above.

$$\sqrt{\frac{1}{N} \sum_{i=1}^N (V_i)^2}$$

**ROM:** Read only memory is any type of memory which cannot be readily rewritten. The information is stored on a permanent basis and used repeatedly. Usually randomly accessible.

**Roof:** The record of points which make the top (or maximum) of an envelope created from a succession of waveforms.

**Rundown:** The discharge of a capacitor at a measured rate.

**Sample and Hold:** A circuit that on command stores on a capacitor the instantaneous amplitude of an input signal.

**Sampling Frequency:** The clock rate at which samples are taken during the process of digitizing an analog signal in a DSO or digitizer.

**SCA:** Single channel analyzer. A circuit which responds only to input signals falling between an upper and lower amplitude level.

**Scalloped Loss:** Loss associated with the picket fence effect.

**Sensitivity:**

1. The minimum signal input capable of causing an output signal with the desired characteristics.

2. The ratio of the magnitude of the instrument response to the input magnitude (e.g., a voltage ADC has a sensitivity that is probably measured in counts/mV). Often, sensitivity is referred to the input and is therefore stated as the inverse.

**Shift Register Scanner:** A circuit that converts parallel inputs (DC level) into serial outputs, with a given frequency.

**Shot Noise:** Noise caused by current fluctuations, due to the discrete nature of charge carriers and random emission of charged particles from an emitter. Many refer to shot noise loosely, when speaking of the mean square shot noise current (amps) rather than a noise power (watts).

**SIPO:** Serial-In, Parallel-Out shift register.



**J. Other Costs & Savings**

The potential benefit of enhanced QA could be enormous. Last year, \$120,000 was expended in reworking defects that could have been caught by in-process QA. Not only will this equipment operate faster, but it will allow an increased number of tests at no extra cost. An estimated minimum reduction in the in-process rework of 20% or \$24,000 is anticipated.

**IV. COST SUMMARY**

**Cash Flow Over Useful Life (\$000)**

Year	1	2	3	4	5	6	7	8	9	10
<b>A. Acquisition Cost Salvage</b>	33.0									(1.0)
<b>B. Obsolescence Cost</b>					5.0					
<b>C. Equipment Salvage</b>										
<b>D. Installation Cost Saving</b>										
<b>E. Training Cost Saving</b>	(3.0)	(3.0)	(3.0)	(3.0)	(3.0)	(3.0)	(3.0)	(3.0)	(3.0)	(3.0)
<b>F. Maintenance Cost Saving</b>	(1.4)	(1.4)	(1.4)	(1.4)	(1.4)	(1.4)	(1.4)	(1.4)	(1.4)	(1.4)
<b>G. Service Cost Saving</b>	(.6)	(.6)	.3	(.6)	(.6)	.3	(.6)	(.6)	.3	(.6)
<b>H. Business Interruption Cost Saving</b>	.7	.7	.7	.7	.7	.7	.7	.7	.7	.7
<b>I. Labor Cost Saving</b>	(30.0)	(30.0)	(30.0)	(30.0)	(30.0)	(30.0)	(30.0)	(30.0)	(30.0)	(30.0)
<b>J. Other Cost Saving</b>	(24.0)	(24.0)	(24.0)	(24.0)	(24.0)	(24.0)	(24.0)	(24.0)	(24.0)	(24.0)
<b>Total Cost Saving</b>	33.7	.7	1.0	.7	5.7	1	.7	.7	1.0	.7
	(62.0)	(62.0)	(62.0)	(62.0)	(62.0)	(62.0)	(62.0)	(62.0)	(62.0)	(63.0)
<b>Net Saving</b>	(28.3)	(61.3)	(61.0)	(61.3)	(56.3)	(61.0)	(61.3)	(61.3)	(61.0)	(62.3)

**V. PAYBACK ANALYSIS**

$$\frac{\text{Cost}}{\text{monthly savings}} = \frac{\$33,000}{\$62,000/12} = 6.4 \text{ months}$$



# Applications Literature

## MEASUREMENT TECHNIQUES & CONCEPTS

	APP. NOTE NO.
How to Measure RMS Using the LeCroy 9400 Digital Oscilloscope	ITI-001
Single-Shot Bandwidth as a Function of Memory Length in Digital Oscilloscopes	ITI-007
Benefits of Long Memories in Digital Oscilloscopes	ITI-008
How to Trigger on the Most Elusive Events	ITI-009
Long Memories Provide Higher Analog Bandwidth	ITI-010
Enhanced Resolution for the LeCroy 9420/24/50 Oscilloscopes	ITI-011
Dynamic Performance Testing of High Speed Transient Recorders at LeCroy	ATS-2004
Determining Digitizer Performance Through Visual Methods	ATS-2005
Segmentation of Memory Using Burst Mode on LeCroy TR8828 Series	ATS-2014
Fast Switch Between Waveform Catalyst Acquisition Software and ASYST Signal Processing on IBM PC/AT	ATS-2016
Principles of Digital Signal Processing	ATS-2018
Fundamentals of Digital Scopes and Digitizers	CSD-001
Fundamentals of Analog to Digital Conversion	CSD-002
Fundamentals of Aliasing	CSD-003
Understanding Effective Bits	CSD-004
The Hows and Whys of Arbitrary Function Generators	SSD-AN-005

## APPLICATIONS

Generating Test Signals for High Resolution Video	SSD-VIDEO
The 9400 Oscilloscope in Ultrasonics	ITI-003
Vibration Analysis Now Works on Reciprocating Engines	ITI-004
Modular Waveform Digitizers for Medical Ultrasound Applications	ATS-2012
High-voltage Breakdown Measurements Using LeCroy Modular Digitizers	ATS-2013
Disk Drive Testing with LeCroy 9100 Arbitrary Function Generator	SSD-OP-1
EMP Testing with LeCroy 9100 Series Arbitrary Function Generators	SSD-AN-04
Arbitrary Function Generator Test Strategies	SSD-EE-989

## INTERFACING AND STANDARDS

Linking the Lecroy 9400 to an IBM PC/AT	ITI-002
Linking the LeCroy 9400 to an IBM PC/AT via GPIB	ITI-005
Linking the LeCroy 9400 to a Hewlett Packard 9000 Model 216 Controller	ITI-006
Linking the LeCroy 9100 to a Tektronix 2430A via GPIB	SSD-PN-01
Linking the LeCroy 9100 to a Hewlett Packard 300 Computer via GPIB	SSD-PN-02A
Programming CAMAC Instruments through a CAMAC to GPIB Interface Using an Hewlett Packard 9845	ATS-2001
GPIB Device Commands for LeCroy Model TR8818 or TR8828C Transient Recorders Using the LeCroy Model 8901 or 8901A GPIB Interface	ATS-2011
Programming LeCroy GPIB Modular Digitizers With a Hewlett Packard 9836 Desk-top Computer	ATS-2015
Modular Waveform Digitizers for Seismologic Applications	ATS-2019
Ignition Testing Using Model 6810	ATS-2020
Introduction to CAMAC	CSD-005



# Attenuation of Cables

Attenuation of Cables

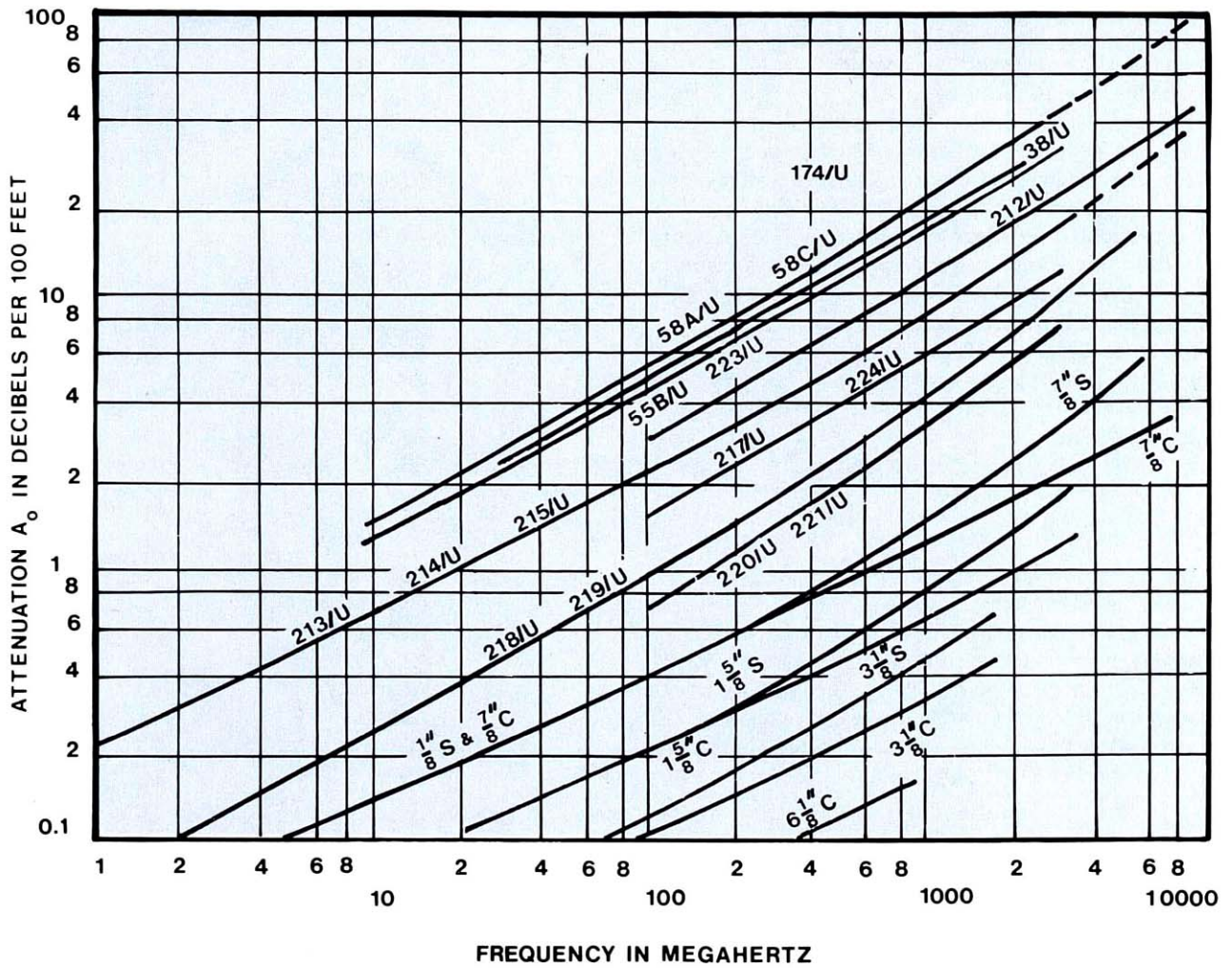

2004

S = Semi-rigid 50Ω  
C = Rigid copper coax.



## Attenuation of Cables

Class of Cables	JAN Type RG.	Inner Conductor	Propagation Delay V/C at 1 MHz	Nominal Diameter of Dielectric (in.)	Nominal Capacitance (pF/ft)	Maximum Operating Voltage (rms)	Remarks
High Temp: Single Braid	178B/U	7/0.004" Silvered Copper Covered Steel	.7071	0.034	29.0	1,000	Z=50 ohms
	179B/U	Same as above	.7071	0.063	20.0	1,200	
	196A/U	Same as above	.7071	0.034	---	1,000	Miniaturized cable. Z=50 ohms. Teflon Dielectric
	211A/U	0.190" Copper	.7071	0.620	29.0	7,000	Semiflexible cable operating at -55°C to +200°C (formerly RG-117A/U). Z=50 ohms 0.450 lb/ft.
	228A/U	0.190" Copper	.7071	0.620	29.0	7,000	Same as RG-211A/U, but with armor (formerly RG-118A/U). Z=50 ohms. 0.600 lb/ft.
	303/U	0.039" Silvered Copper-Covered Steel	.7071	0.116	28.5	1,900	Z=50 ohms
	304/U	0.059" Silvered Copper-Covered Steel	.7071	0.185	28.5	3,000	Z= 50 ohms
	316/U	7/0.0067" Annealed Silvered Copper Covered Steel	.7071	0.060	---	1,200	Miniaturized Cable. Z = 50 ohms.
High Temp: Double Braid	115/U	7/0.028 Silvered Copper	.7071	0.250	29.5	5,000	Medium Size cable for use where expansion and contraction are a major problem. Z=50 ohms.
	142B/U	0.039" Silvered Copper-Covered Steel	.7071	0.116	28.5	1,900	Small-Size Flexible Cable. Z = 50 Ohms.
	225/U	7/0.0312" Silvered Copper	.7071	0.285	29.5	5,000	Semi-flexible cable operating at -55°C to +200° C (formerly RG-87A/U). Z=50 ohms.0.176 lb/ft.
	227/U	7/0.0312" Silvered Copper	.7071	0.285	29.5	5,000	Same as RG-225/U but with armor (formerly RG-116/U) Z=50 ohms. 0.224 lb/ft.
High Attenuation: Single Braid	301/U	7/0.0203" Karma Wire	.7071	0.185	29.0	3,000	High -Attenuation cable. Z=50 ohms.
50 ohms: Single Braid	58/U	1/0.032" Copper	0.649	0.121	28.5	1,900	0.024 lb/ft.
	58A/U	19/0.0071" Copper	0.649	0.120	29.5	1,900	0.025 lb/ft.
	58C/U	19/0.0071" Tinned Copper	0.65938	0.116	28.5	1,900	Small -size flexible cable, 0.029 lb/ft.
	213/U	7/0.0296" Copper	0.65938	0.285	29.5	5,000	Medium -Size flexible cable (formerly RG-8A/U), 0.120 lb/ft.
	215/U	7/0.0296" Copper	0.65938	0.285	29.5	5,000	Same as RG-213/U, but with armor (formerly RG-10A/U), 0.160 lb/ft.
	218/U	0.195" Copper	0.65938	0.680	29.5	11,000	Large Size low-attenuation high-power transmission line (formerly RG-17A/U). 0.491 lb/ft.
	219/U	0.195" Copper	0.65938	0.680	29.5	11,000	Same as RG-218/U, but with armor (formerly RG-18 A/U). 0.603 lb/ft.
	220/U	0.260" Copper	0.65938	0.910	29.5	14,000	Very -large low-attenuation high-power transmission cable (formerly RG-19A/U). 0.745 lb/ft.
	221/U	0.260" Copper	0.65938	0.910	29.5	14,000	Same as RG-220/U, but with armor (formerly RG-20A/U). 0.925 lb/ft.
	50 ohms: Double Braid	55B/U	0.032" Silvered Copper	0.65938	0.116	28.5	1,900
212/U		0.0556" Silvered Copper	0.65938	0.185	28.5	3,000	Small size microwave cable (formerly RG-5B/U).0.093 lb/ft.
214/U		7/0.0296" Silvered Copper	0.65938	0.285	30.0	5,000	Special medium-size flexible cable (formerlyRG-9B/U, 0.158 lb/ft
217/U		0.106" Copper	0.65938	0.370	29.5	7,000	Medium Size power transmission line (formerly RG-14A/U), 0.236 lb/ft.
223/U		0.035" Silvered Copper	0.65938	0.116	28.5	1,000	Small size flexible cable (formerly RG-55A/U), 0.036 lb/ft.
224/U		0.106" Copper	0.65938	0.370	29.5	7,000	Same as RG-217/U, but with armor (formerly RG-74A/U), 0.282 lb/ft.
Misc:		174/U	7/0.0063" Copper Covered Steel	0.649	0.060	30.0	1,500
	59/U	1/0.0253" Copper Covered Steel	0.649	0.150	21.0	2,300	High Voltage. Z = 73 ohms.
	59B/U	1/0.023" Copper Covered Steel	0.649	0.150	20.5	2,300	High Voltage. Z = 75 ohms.
	62/U	1/0.025" Copper Covered Steel	0.833	0.250	13.5	750	Z=93 ohms.
	62A/U	1/0.025" Copper Covered Steel	0.833	0.249	13.5	750	Z=93 ohms



# Conversions, Resistor Codes

## Conversions

Powers of 2	Decibel Equivalents		Octal	Decimal	Hexadecimal
$2^0 = 1$	0 dB=	1.0000	100	64	40
$2^1 = 2$	1 dB=	1.1220	1,000	512	200
$2^2 = 4$	2 dB=	1.2589	2,000	1,024	400
$2^3 = 8$	3 dB=	1.4125	3,000	1,536	600
$2^4 = 16$	4 dB=	1.5849	4,000	2,048	800
$2^5 = 32$	5 dB=	1.7783	5,000	2,560	A00
$2^6 = 64$	6 dB=	1.9953	6,000	3,072	C00
$2^7 = 128$	7 dB=	2.2387	7,000	3,584	E00
$2^8 = 256$	8 dB=	2.5119	10,000	4,096	1,000
$2^9 = 512$	9 dB=	2.8184	20,000	8,192	2,000
$2^{10} = 1,024$	10 dB=	3.1623	30,000	12,288	3,000
$2^{11} = 2,048$	11 dB=	3.5481	40,000	16,384	4,000
$2^{12} = 4,096$	12 dB=	3.9811	50,000	20,480	5,000
$2^{13} = 8,192$	13 dB=	4.4668	60,000	24,576	6,000
$2^{14} = 16,384$	14 dB=	5.0119	70,000	28,672	7,000
$2^{15} = 32,768$	15 dB=	5.6234	100,000	32,768	A,000
$2^{16} = 65,536$	16 dB=	6.3096	200,000	65,536	10,000
$2^{17} = 131,072$	17 dB=	7.0795	300,000	98,304	18,000
$2^{18} = 262,144$	18 dB=	7.9433	400,000	131,072	20,000
$2^{19} = 524,288$	19 dB=	8.9125	500,000	163,840	28,000
$2^{20} = 1,048,576$	20 dB=	10.0000	600,000	196,608	30,000
			700,000	229,376	38,000

Common Tap and Clearance Drill Sizes					Resistor Color Code	
Screw	Tap No.	Dia. (inches)	Clearance No.	Dia. (inches)		
2-56	50	0.070	42	0.094	0	Black
4-40	42	0.094	31	0.120	1	Brown
6-32	36	0.107	27	0.144	2	Red
8-32	29	0.136	18	0.170	3	Orange
10-24	25	0.150	9	0.196	4	Yellow
1/4-20	---	17/64	7	0.201	5	Green
					6	Blue
					7	Violet
					8	Gray
					9	White
					5%	Gold
					10%	Silver
					20%	No Band

Useful Conversion Factors		Prefixes		
2.2046 lb/kg	0.4536 kg/lb	Tera	$10^{12}$	T
0.2642 gal/l	3.7850 l/gal	Giga	$10^9$	G
0.03937 mils/ $\mu$	25.40 $\mu$ /mil	Mega	$10^6$	M
57.296 $^\circ$ /rad	0.01745 rad/ $^\circ$	Kilo	$10^3$	K
$3.1558 \times 10^7$ sec/yr $\cong \pi \times 10^7$ sec/yr		Milli	$10^{-3}$	m
		Micro	$10^{-6}$	$\mu$
		Nano	$10^{-9}$	n
		Pico	$10^{-12}$	p
		Femto	$10^{-15}$	f
		Atto	$10^{-18}$	a

Resistance =  $ab \times 10^c \pm d$



## Ordering Information

### REQUESTS FOR QUOTATION AND TECHNICAL INFORMATION

LeCroy's worldwide network of offices and technical sales engineers will assist you in specifying, ordering, installing and operating LeCroy equipment. Please refer to the Sales and Service offices in Appendix G for the one nearest you.

### PRICING

Export prices are available from our worldwide sales offices. Prices in the U.S.A. can be obtained by calling either your local sales office direct number or dialing 1-800-5-LeCroy.

### HOW TO ORDER

When placing an order, please specify the model number as well as the name of the instrument. Many model numbers include letter designations such as the 9450WP01 or the DP9001. Some models are offered with several options designated by a slash followed by a number such as P9010/2. Special care should be taken to include these alphanumeric designations on your order.

### MINIMUM ORDER

All purchase orders are subject to a \$100.00 minimum value for USA products and SFR 200 - for Swiss products.

**U.S. Government Sales:** Most products listed in this catalog are on G.S.A. Federal Supply Schedule Contract. See Appendix F. Please verify pricing with your local sales office and/or obtain a copy of the LeCroy G.S.A. Price List.

### WHERE TO ORDER AND CURRENCY

Purchase orders may be forwarded to your local sales office or directly to the manufacturing facility producing the product you desire. Your local currency may be used for orders placed with direct LeCroy subsidiaries or sales representatives. A list of all the sales offices and representatives is given in Appendix G.

Rental company orders within the U.S.A. should be called in directly to Corporate Headquarters in New York at (914) 578-6066.

### LEASING

Leases may be handled through a leasing firm of your choice or through First Industrial Commercial Finance Corp., 30 Ridgedale Avenue, East Hanover, New Jersey 07936; Phone: (201) 428-4746; FAX (201) 428-4758; Attn.: Russ Benson or Bob Petty.

### ACKNOWLEDGEMENT

When a purchase order is accepted by LeCroy Corporation, an acknowledgement is issued immediately confirming the equipment type, quantity and price, and indicating an estimated delivery date. Please read this acknowledgement carefully. Any unacceptable discrepancy between the purchase order and the acknowledgement should be reported immediately to the local sales office.

### SHIPPING

The standard FOB point for all orders placed in the United States is Chestnut Ridge, New York. The standard shipping method for most products is via two-day parcel service. Some products require either air freight or motor freight.

Special shipping instructions should be arranged prior to placing a purchase order so that any additional shipping charges are properly taken into account.

### TERMS

**Domestic Orders:** Payment terms are "Net 30-Days, acceptance period included" for all orders originating within the United States. The 30-day period begins on the actual shipping date. Any exception to these payment terms should be requested before placing a purchase order. Credit references will be required for new customer accounts.

**Export Orders:** For orders placed directly with LeCroy's main location in Chestnut Ridge, New York in U.S. dollars, payment terms for orders less than \$5,000. are via 30-day date draft, acceptance period included. >\$5,000. - Irrevocable Letter of Credit drawn on The Bank of New York, 48 Wall Street, New York, N.Y., 10015, USA. For the account name of LeCroy Corp. at The Bank of New York in Spring Valley, N.Y., Acct. #254-00-8881, Routing Code: 50-244/219.

For orders placed in Swiss Francs directly with LeCroy's European Headquarters in Geneva, Switzerland, for digital oscilloscope products, payment terms for less than SFR 10,000 are 30-day date draft, acceptance period included. >SFR 10,000 - Irrevocable Letter of Credit drawn on Credit Suisse, Charmilles - Balexert, Geneva, Switzerland.

Terms for orders placed with LeCroy export sales subsidiaries are Net 30-days, unless other special arrangements have been made in advance.







## Sales Offices

### United States

#### VT, NH, MA, ME, RI, CT, UP NY

LeCroy Corporation  
340 Commercial Street  
Manchester, N.H. 03101  
Phone: (603) 627-6303  
FAX: (603) 627-1623

#### NYC, NY-LI, UP NY

LeCroy Corporation  
690 Chestnut Ridge Road  
Chestnut Ridge, New York  
10977-6499  
Phone: (914) 578-6064  
FAX: (914) 425-8967

#### W NJ, N NJ, E PA, W PA, W MD, WV, BOYD KY

LeCroy Corporation  
690 Chestnut Ridge Road  
Chestnut Ridge, New York  
10977-6499  
Phone: (914) 578-6091 or  
(914) 425-2000 Ext 3191  
FAX: (914) 425-8967

#### DC, MD, VA

LeCroy Corporation  
7000 Infantry Ridge Road  
Suite 100  
Manassas, Virginia 22110  
Phone: (703) 368-1033  
FAX: (703) 361-6968

#### S NJ, DE, SE PA, MD, W VA

LeCroy Corporation  
1003 Old Philadelphia Road  
Suite 101  
Aberdeen, Maryland 21001  
Phone: (301) 575-7544  
FAX: (301) 272-5295

#### FL, MS, PR

LeCroy Corporation  
410 Ware Boulevard  
Suite 517  
Tampa, Florida 33619  
Phone: (813) 626-1818  
FAX: (813) 621-7964

#### SW VA, NC, SC, E TN

LeCroy Corporation  
8501 Castlekeep Road  
Charlotte, North Carolina 28226  
Phone: (704) 542-9787

#### AL, GA, W TN

LeCroy Corporation  
8244 Carrington Way  
Hiram, Georgia 30141-2007  
Phone: (404) 439-5139

#### IL, WI, MN, IA, E MO, W MO, ND, SD, E NE

LeCroy Corporation  
9401 West Beloit Road, No. 312  
Milwaukee, Wisconsin 53227  
Phone: (414) 545-6505  
FAX: (414) 545-2630

#### KY, IN, N OH, S OH, MI

LeCroy Corporation  
4306 Rosedale Road  
Middletown, Ohio 45042  
Phone: (513) 422-0112

#### NM, AZ, S NV, W TX

LeCroy Corporation  
14800 Central Avenue, S.E.  
Albuquerque, N.M. 87123  
Phone: (505) 293-8100  
FAX: (505) 293-9617

#### S TX, LA

LeCroy Corporation  
16720 Stuebener Airline Road  
Suite 222  
Spring, Texas 77379  
Phone: (713) 370-8255  
FAX: (713) 251-5766

#### N TX, OK, AR, KS

LeCroy Corporation  
7700 Bogart  
Fort Worth, Texas 76180  
Phone: (817) 577-1401  
FAX: (817) 581-2208

#### N CA, N NV, HI, TRIUMF

LeCroy Corporation  
5912 Stoneridge Mall Road  
Suite 150  
Pleasanton, California 94566  
Phone: (415) 463-2600  
FAX: (415) 463-9179

#### S CA, SAN DIEGO CA

LeCroy Corporation  
16200 Ventura Boulevard  
Suite 223  
Encino, California 91436  
Phone: (818) 788-5552  
FAX: (818) 788-4967

#### S CA

LeCroy Corporation  
9650 Business Center Drive  
Suite 125  
Rancho Cucamonga, CA 91730  
Phone: (714) 944-7991

#### UT, CO, WY, E ID, E MT, W NE

LeCroy Corporation  
7500 East Arapahoe Road  
Suite 335  
Englewood, Colorado 80112  
Phone: (303) 741-0537  
FAX: (303) 741-1619

## International

#### WESTERN ONTARIO

Rayonics Scientific, Inc.  
1655 Flint Road  
Downsview, Ontario M3J 2W8  
Phone: (416) 736-1600  
FAX No: (416) 736-1607

#### QUEBEC

Rayonics Scientific, Inc.  
6618 Vanden Abeele  
Ville St. Laurent, Quebec  
H4S 9Z7  
Phone: (514) 335-0105  
FAX: (514) 336-7735

#### SASKATCH, ALBERTA, BC

Rayonics Scientific, Inc.  
4506 Dawson Street  
Burnaby, B.C. V5C 4C1  
Phone: (604) 293-1854  
FAX: (604) 298-2874  
Calgary: (403) 280-7123

#### MARITIME PROVINCES

Rayonics Scientific, Inc.  
473A Windmill Road  
Dartmouth,  
Nova Scotia B3B 1B2  
Phone: (902) 463-3344  
FAX: (902) 465-2370

#### EAST ONTARIO AND MANITOBA

Rayonics Scientific, Inc.  
2485 Lancaster Road  
Unit 10  
Ottawa, Ontario K1B 5L1  
Phone: (613) 521-8251  
FAX: (613) 521-0592

#### ARGENTINA

Search SA  
Corrientes 617, 6° Piso  
1043 Buenos Aires  
Phone: (01) 394.5882  
FAX: (01) 111403 Telex: 24447

#### AUSTRALIA

Scientific Devices  
Australia Pty. Ltd.  
2 Jacks Road  
South Oakleigh, Victoria  
Phone: (61) 3 579 3622  
FAX: (61) 3 579 0971

#### AUSTRIA

Dewetron Elektronische  
Messgeraete Ges. M.B.H.  
Foellingerstrasse 9E  
A-8044 Graz  
Phone: (316) 391804  
FAX: (316) 391052.9



## BELGIUM, NETHERLANDS

LeCroy B.V.  
Waalreneweg 17  
NL-5554 HA Valkenswaard  
Phone: (04902) 8.9285  
FAX: (04902) 42628  
Telex: 59032

## BRAZIL

Rua Da Quitanda  
194-Sala 404  
CEP 20091, Rio De Janeiro  
Phone: (021) 233.5590  
Telex: 021 37645

## DENMARK

Lutronic  
Vibeholms Alle 11-15  
DK-2600 Glostrup  
Phone: (42) 45.97.64  
FAX: (42) 63.07.20

## FINLAND

Labtronic OY  
Box 34  
01721 Vantaa  
Phone: (0) 84 71 44  
FAX: (0) 84 37 08  
Telex: 124990

## FRANCE

LeCroy SARL  
Avenue du Parana, B.P. 214  
F-91941 Les Ulis Cedex  
Phone: (1) 69.07.38.97  
FAX: (1) 69.07.40.42  
Telex: 602838 F

## GREECE

Hellenic Scientific  
Representations Ltd.  
11 Vrassida Street  
GR-115 28 Athens  
Phone: (01) 721 1140  
(01) 721 3154  
Telex: 219330

## INDIA

Electronic Enterprises  
Post Bag No. 6367, Unit 216  
Regal Industrial Estate  
Acharya Donde Marg, Sewri  
Bombay-400015  
Phone: (022) 413 33 41  
(022) 413 70 96  
FAX: (022) 4133341  
Telex: 11-71071/11-76055

## ISRAEL

Ammo  
60 Pinkas Street  
P.O. Box 21362  
61213 Tel Aviv  
Phone: (03) 453 157  
FAX: (03) 459 281  
Telex: 342105

## ITALY

LeCroy S.r.l.  
Via Roccaporena 58  
I-00191 Roma  
Phone: (06) 302.96.46  
FAX: (06) 327.92.21  
Telex: 621501

LeCroy S.r.l.  
Via Pinturicchio, 9  
I-20133 Milano  
Phone: (02) 20.47.082  
FAX: (02) 20.47.026

## JAPAN

TOYO Corporation  
Daito Building 2-1-Chome  
Hongoku-Cho, Nihonbashi  
Chuo-ku Tokyo 103  
Phone: (03) 279.0771  
FAX: (03) 246.0645  
Telex: 2222973

## KOREA

Samduk Science and  
Ind. Co., Ltd.  
K.P.O. Box 1253  
Cheongjin Building, Room 305  
23-4, 2-Ga, Seongsoo-Dong  
Seong Dong-Ku, Seoul  
Phone: (2) 468.0491  
FAX: (2) 468.0495  
Telex: 25808

## MEXICO

NUCLEOELECTRONICA, SA  
Calz. Las Aguilas 101  
Delegacion Alvaro Obregon  
01710 Mexico, 20 d.f.  
Phone: (905) 593-6043  
FAX: 180361

## NEW ZEALAND

E. C. Gough, Ltd.  
245 St. Asaph Street  
P.O. Box 22073  
Christchurch  
Phone: (03) 798.740  
FAX: (03) 796.776  
Telex: 4864

## PAKISTAN

Electro Tech Corporation Ltd.  
1st Floor, 16 Kazi Chambers  
Bahadurshah Zafar Road  
Karachi-5  
Phone: (021) 418 087  
Telex: 95225700 KCC PK

## SOUTH AFRICA

Westplex Test and  
Measurement (Pty) Ltd.  
P.O. Box 1765  
Randburg 2125  
Republic of South Africa  
Phone: (011) 787.0473  
FAX: (011) 787.0237  
Telex: 421295

## SPAIN

Anadig Ingenieros, SA  
Amado Nervo 3  
E-28007 Madrid  
Phone: (1) 4332412  
FAX: (1) 552.37.22  
Telex: 43104

## SWEDEN

Measurement Systems  
Scandinavia AB  
P.O. Box 393  
Sagvagen 13  
S-184 24 Akersberga  
Phone: (46) 764.68100  
FAX: (46) 764.66536

## SWITZERLAND

**LECROY SA**  
2, chemin Pré-de-la-Fontaine  
P.O. Box 314  
CH-1217 Meyrin 1  
Geneva  
Phone: (022) 719.21.11  
FAX: (022) 782.39.15  
Telex: 419058

## TAIWAN

Topward Electric Instruments  
Co., Ltd.  
No. 26, Kong 4th Rd  
Linkou 2nd Industrial Park,  
Taipei Hsien  
Phone: (02) 6018801  
FAX: (02) 6018367  
Telex: 33514

## THAILAND

Measuretronix, Ltd.  
2101/63 Ramkamkaeng Road  
Huamark, Bangkok  
Phone: (02) 3742516/(02)  
3741632  
Telex: 82796

## UNITED KINGDOM

LeCroy LTD  
28 Blacklands Way  
Abingdon Business Park  
GB-Abingdon, OXON OX14 1DY  
Phone: (0235) 33114  
FAX: (0235) 28796  
Telex: 837539

## WEST GERMANY

LeCroy GmbH  
Postfach 10-37-67  
Werderstrasse 48  
D-6900 Heidelberg  
Phone: (06221) 49162  
FAX: (06221) 411868  
Telex: 461680



# Sample Capital Equipment Justification

In Process Test Dept. Upgrade  
Program

*B. Devons*

Submitted By

## I. EXECUTIVE SUMMARY

This program increases both the output and capability of existing staff while automating many of the unpleasant operations. This should eliminate the necessity to add staff to service current demands. Savings on in-process test labor, rework variances, maintenance cost and accompanying downtime justify the acquisition expenditure.

## II. PROGRAM DESCRIPTION

The manufacturing department maintains an in-process QA section manned by four operators and a group leader for the purpose of performing AC tests on major board level subassemblies and switching power supplies. We are having a very difficult time locating operators who are both qualified to perform complex tasks on the existing equipment and willing to handle the tedious, repetitive operations. The group's capacity and quality has not kept pace with the growth in workload, causing substantial rework variances. This program is designed to increase capability and capacity without addition of personnel.

## III. COST OF OWNERSHIP

### A. Equipment Cost & Salvage Value

LeCroy 7200 Modular Oscilloscope with one Model 7242 Dual Channel 1 GHz Plug In, \$33,000. Salvage value: \$1000.

### B. Useful Life Obsolescence, Costs & Savings

10+ years. This is much longer than the equipment being replaced because of modular design and capability of updating to current technology (or changing needs) by replacing the plug in only (\$5,000 has been budgeted in year 5 for such an upgrade). Modularity is also a valuable service benefit.

### C. Equipment Replaced

150 MHz analog scope and a sampling scope with salvage value of \$0.00

### D. Installation & Software Development Cost & Savings

None! 2 weeks were required to get GPIB running on existing set up and 2 months of programming time. This equipment has analysis functions built-in and measurement sequences are created just by operating unit in a "learn" mode. Using previous methods, development costs of \$10,000 would be incurred.



---

## Appendix H

---

### **E. Training Costs & Savings**

Unit operates very similar to existing equipment; little or no operator training required. Built-in Help Manual for new operators. Reduced training requirements will save 5% of an operator year (\$3,000).

### **F. Yearly Maintenance Costs & Savings**

LeCroy unit self-calibrates. No scheduled maintenance is required. First two years software upgrades at no charge. This replaces two calibrations/year/scope and saves \$1400.

### **G. Service Costs & Savings**

First two years warranty service: no charge. Estimate one service every 3 years @ \$300. This replaces one service/year/scope = \$600.

### **H. Business Interruption Costs & Savings**

LeCroy's Blue Ribbon Program guarantees 3 day repairs, (plus toll-free applications hotline, extra documentation, etc.; support is available even if the unit never fails) at 2% of sale/price/year.

When current equipment fails, it is out for service for 6 weeks. Replacements are rented at \$1000/month/scope.

### **I. Labor Costs & Savings**

Setups may be recalled from floppy disk. This is very useful given the wide variety of tests we do. We envision one disk per product to be developed and shared by Engineering, QA, and Field Service. All tests will be coordinated, eliminating the confusion that now occurs. Ten percent of an operator's time will be saved through faster uniform set ups.

This equipment does considerably more than the gear it replaces. For instance, it has built in measurement capabilities (such as waveform parameters for spec'ing risetimes, clock frequencies, etc.; waveform math for power curves; FFT for noise floor analysis) that are currently done visually with low precision, or on other equipment (e.g. computer or spectrum analyzer). These activities will be performed more efficiently using this equipment. In addition, the plan is to take advantage of the extensive automation capabilities which enable test sequences (particularly the tedious, repetitive ones) to be performed at high speed with limited operator intervention. Overall, these capabilities should reduce operator time by 30%.

In addition, there is built-in trending and statistical analysis. These functions, very central to quality monitoring activities, are now done manually (if at all). Unit output (graphics included) is also directly compatible with Ventura Desktop Publishing. An estimated savings of 10% of a man-year in the preparation of QA reports could be realized.

Total labor savings are .5 man-year or \$30,000.



**J. Other Costs & Savings**

The potential benefit of enhanced QA could be enormous. Last year, \$120,000 was expended in reworking defects that could have been caught by in-process QA. Not only will this equipment operate faster, but it will allow an increased number of tests at no extra cost. An estimated minimum reduction in the in-process rework of 20% or \$24,000 is anticipated.

**IV. COST SUMMARY**

**Cash Flow Over Useful Life (\$000)**

Year	1	2	3	4	5	6	7	8	9	10
<b>A. Acquisition Cost</b>	33.0									
<b>Cost Salvage</b>										(1.0)
<b>B. Obsolescence Cost</b>					5.0					
<b>C. Equipment Salvage</b>										
<b>D. Installation Cost Saving</b>										
<b>E. Training Cost Saving</b>	(3.0)	(3.0)	(3.0)	(3.0)	(3.0)	(3.0)	(3.0)	(3.0)	(3.0)	(3.0)
<b>F. Maintenance Cost Saving</b>	(1.4)	(1.4)	(1.4)	(1.4)	(1.4)	(1.4)	(1.4)	(1.4)	(1.4)	(1.4)
<b>G. Service Cost Saving</b>	(.6)	(.6)	.3	(.6)	(.6)	.3	(.6)	(.6)	.3	(.6)
<b>H. Business Interruption Cost Saving</b>	.7	.7	.7	.7	.7	.7	.7	.7	.7	.7
	(3.0)	(3.0)	(3.0)	(3.0)	(3.0)	(3.0)	(3.0)	(3.0)	(3.0)	(3.0)
<b>I. Labor Cost Saving</b>	(30.0)	(30.0)	(30.0)	(30.0)	(30.0)	(30.0)	(30.0)	(30.0)	(30.0)	(30.0)
<b>J. Other Cost Saving</b>	(24.0)	(24.0)	(24.0)	(24.0)	(24.0)	(24.0)	(24.0)	(24.0)	(24.0)	(24.0)
<b>Total Cost Saving</b>	33.7	.7	1.0	.7	5.7	1	.7	.7	1.0	.7
	(62.0)	(62.0)	(62.0)	(62.0)	(62.0)	(62.0)	(62.0)	(62.0)	(62.0)	(63.0)
<b>Net Saving</b>	(28.3)	(61.3)	(61.0)	(61.3)	(56.3)	(61.0)	(61.3)	(61.3)	(61.0)	(62.3)

**V. PAYBACK ANALYSIS**

$$\frac{\text{Cost}}{\text{monthly savings}} = \frac{\$33,000}{\$62,000/12} = 6.4 \text{ months}$$



## Product Index

Model	Div.	Page	Model	Div.	Page	Model	Div.	Page
1434A	ATS	III-71	7900-160	RSD	III-22,35	9424WP02	ITI	I-19
2262	RSD	III-32	7900-40	RSD	III-22,35	9450	ITI	I-4
2323A	RSD	III-42	7900-416	RSD	III-35	9450M	ITI	I-7
4222	ITI	III-42	7900-432	RSD	III-35	9450WP01	ITI	I-16
5612	RSD	III-39	7900-448	RSD	III-35	9450WP02	ITI	I-19
5613	RSD	III-39	7900-464	RSD	III-35	BC/BC-4	ATS	III-35
6010	ATS	III-48	7900-9109LM	RSD	III-23,35	BFP-1	ATS	III-35
6103	ATS	III-36	7900-C100	RSD	III-35	BFP-2	ATS	III-35
6128	ATS	III-46	7900-E100	RSD	III-35	CA9001	ITI	I-52
6309	ATS	III-17	7900-E150	RSD	III-35	CA9002	ITI	I-52
6309/6389	ATS	III-17	7900-IF211	RSD	III-35	CK8212	ATS	III-35
6310	ATS	III-24	7900-IF212	RSD	III-35	CKDLEM	ATS	III-35
6389	ATS	III-17	7900-IF213	RSD	III-35	CKLEM	ATS	III-35
6399	ATS	III-17	7900-IF214	RSD	III-35	DC/GPIB	ATS	III-35
6810	ATS	III-24	7900-IF251	RSD	III-23,35	DC/RS232	ITI	I-51
6880B	ATS	III-6	7900-IF280	RSD	III-35	DC6010	ATS	III-35
6900-287	ATS	III-35	7900-SI100	RSD	III-35	DC8134/N	ATS	III-35
6900-3	ATS	III-58	7900-SU100	RSD	III-35	DC8150/N	ATS	III-35
6900-3S	ATS	III-58	7900-SV100	RSD	III-35	DC8800/N	ATS	III-31
6900-5	ATS	III-58	7900-T100	RSD	III-35	DP9001	ITI	I-51
6900-5S	ATS	III-58	8013A	ATS	III-71	DP9003	ITI	I-51
6900COMP3	ATS	III-35	8025	ATS	III-74	IF/PC2	ITI	I-52
6900EGA	ATS	III-35	8102	ATS	III-36	IP-2	ITI	I-52;III-35
6900IC	ATS	III-35	8212A	ATS	III-30	KEYBOARD1	ATS	III-35
6909-3	ATS	III-58	8800A	ATS	III-30	LE/BC-6	ATS	III-35
6910-DEV	ATS	III-59	8901A	ATS	III-54	LE/LE-3	ATS	III-35
6910-EXE	ATS	III-59	9100	SSD	II-4	MM8103A	ATS	III-12
6920-488	ATS	III-63	9100/CP	SSD	II-5,7	MM8104	ATS	III-12
6920-DL	ATS	III-63	9100/EC	SSD	II-7	MM8105	ATS	III-12
7200	ATS	I-40	9100/OM	SSD	II-7	MM8106	ATS	III-12-16
7200-OM	ATS	I-47	9100/SW	SSD	II-16	MONITOR1	ATS	III-35
7200-PM	ATS	I-47	9100/GPIB2	SSD	II-7	MONITOR2	ATS	III-35
7200-P10	ATS	I-51	9101	SSD	II-8	OC9001	ITI	I-52
7200-P21	ATS	I-51	9109	SSD	II-10	OM9424	ITI	I-15
7200-RKMT	ATS	I-53	9400A/G	ITI	I-23	OM9450	ITI	I-7
7200-SHIP	ATS	I-53	9400AIM01	ITI	I-35,26	OM9420	ITI	I-11
7200-SM	ATS	I-47	9400AMS01	ITI	I-34,26	P9010	ITI	I-51
7200-SOFT	ATS	I-53	9400AOP01	ITI	I-26	P9010/2	ITI	I-51
7200-SUP	ATS	I-47	9400AWP01	ITI	I-27	P9011	ITI	I-51
7242	ATS	I-40,46	9400AWP02	ITI	I-30	P9020	ITI	I-51
7242-OM	ATS	I-47	9400CS01	ITI	I-37	P9100	ITI	I-51
7242-PM	ATS	I-47	9400CS02	ITI	I-37	RM9400	ITI	I-53
7242-SM	ATS	I-47	9400MS02	ITI	I-34	TC9001	ITI	I-53
7900-001	RSD	III-35	9420	ITI	I-8	TC9002	ITI	I-53
7900-002	RSD	III-35	9420M	ITI	I-11	TC9003	ITI	I-53
7900-10	RSD	III-35	9420WP01	ITI	I-16	TR8818A	ATS	III-12
7900-104	RSD	III-35	9420WP02	ITI	I-19	TR8828D	ATS	III-12
7900-108	RSD	III-35	9424	ITI	I-12			
7900-112	RSD	III-35	9424WP01	ITI	I-16			



# Subject Index

Description	Model/Subject	Page	Description	Model/Subject	Page
ADC's, Fundamentals of AFG	Theory	IV-32	Bandwidth vs. Time-Base Graphs	9450	I-5
Analog & Digital Outputs	9109,9112	II-10,12	9420	9420	I-9
Architecture	Theory	IV-48,55	9424	9424	I-13
Dual Channels	Theory	IV-52	9400A	9400A	I-24
Extending Dynamic Range	Theory	IV-53	Cables, Attenuation of	Appendix C	V-10
Internal Channel Summing	9100/09/12	II-4,10,12	Calibration Software	9400 Series	I 37-39
Memories, Definitions of	Theory	IV-57	6880B	6880B	III-9
The Hows and Whys of	Theory	IV-48	CAMAC, Introduction to	Theory	III-80
200 MP/s,8-bit,2 ch	9100	II-4	Capital Equipment Justification	Appendix H	V 17-19
200 MP/s,8-bit,1 ch	9101	II-8	Catalyst	6900	III-56
200 MP/s,2 ch, dig.o/p	9109	II-10	Controller, Modular	6010	III-48
50 MP/s,2 ch,12-bit	9112	II-12	Conversion Tables	Appendix D	V-12
Aliasing, Fundamentals of	Theory	IV 36-39	Crate, CAMAC		
Amplifier, Modular	6103	III-36	650 W, 25 slots	1434A	III-71
Analog Transmitter/Rcvr	5612/13	III-39,41	400 W, 13 slots	8013A	III-71
Analog to Digital Conversion	Theory	IV-32	1000 W, 25 slots	8025	III-74
Dual Rank		IV-32	Delay Generator	2323A	III-42
Flash Converters		IV-32	4222	4222	III-42
Interleaved Flash Converters		IV-33	Development Software	6910-DEV	III-59
Wilkinson Rundown		IV-34	Differential Inputs	6810	III-25
Successive Approximation		IV-35	Digital Oscilloscopes		
Applications Literature Listing	Appendix B	V-9	About DSO's	Theory	I-2, IV-1
Arbitrary Function Generator			Accuracy, Vertical	Theory	I-2;IV-6,19
Analog & Digital Outputs	9109,9112	II-10,12	Advantages	Theory	I-2,ix-xv
Architecture	Theory	IV-48,55	Bandwidth	Theory	I-2,48;IV-4
Dual Channels	Theory	IV-52	Camera, Adapter	CA9001,02	I-52
Extending Dynamic Range	Theory	IV-53	Carrying Cases	7200,9400	I-53
Internal Channel Summing	9100/09/12	II-4,10,12	Carts	OC9001	I-52
Memories, Definition of	Theory	IV-57	Cost Justification	Appendix H	V-17
The Hows and Whys of	Theory	IV-48	Display	Theory	I-3,48;IV-10,19
When to Use	Theory	IV-48;II-3	Fundamentals of	Theory	IV-1
200 MP/s,8-bit,2 ch	9100	II-4	Justifying	Intro	ix-xiv
200 MP/s,8-bit,1 ch	9101	II-8	GPIB Card	IF/PC2	I-52
200 MP/s,2 ch, dig.o/p	9109	II-10	High Impedance Driver	D9010	I-52
50 MP/s,2 ch,12-bit	9112	II-12	High Voltage Protector	SG9001	I-52
ATE	7200 Series	I-45	Memories, Long	Theory	I-3;IV-8,14
	Theory	IV-13	Modular, Plug-ins	7200 Series	I-40
Attenuation of Cables	Appendix C	V-10	Quad, 4-channel	9424	I-12
Attenuator, Modular	8102	III-36	Plotters	DP9001	I-51
Averaging	Theory	IV-6,43	Printers	DP9003	I-51
	9420/24/50	I 16-18,50	Probes	P9010,10/2,	I-51
	9400A	I 27-29,50		P9020,P9100	I-51
	7200 Series	I 41,44,47		P9011,7200- P10,	I-51
	6010	III 50,52,53		7200-P21	I-51
	6880B	III-8,10	Pulser	IP-2	I-52
	6810	III-29	Rack Mounts	RM9400	I-53
	6900	III-57		7200-RKMT	I-53
			Selection Guide		I-1
			Trigger, How to	Theory	IV-24



# Appendix K

Description	Model/Subject	Page	Description	Model/Subject	Page
(Digital Oscilloscopes cont.)			Mass Storage	9400A	I 34-36
350 MHz, 400 MS/s, 2 ch.	9450	I-4		7200 Series	I 41, 42, 47
350 MHz, 100 MS/s, 4 ch.	9424	I-12		7900	III 20-23
350 MHz, 100 MS/s, 2 ch.	9420	I-8	Memories, Long		
400 MHz, 1 GS/s	7200 Series	I-40	Benefits of	Theory	IV-14
175 MHz, 100 MS/s	9400A	I-23	Digital Scopes	9450	I-5, 6
Digitizers				9420	I-10
Architectures	Theory	IV-10		9424	I-14
Fundamentals of	Theory	IV-1		9400A	I-23, 25, 48
How to Configure	Theory	III-5		7200 Series	I-42, 46, 47
Low Cost	2662	III-32	Selection Guide		III-4
Selection Guide	Theory	III-4	Snapshot Recorder	6389/6309	III-17
Dithering	Theory	IV-44	Wavecorder	7900 Series	III-20
Dynamic Accuracy	Theory	IV-6, 7	Modular Digitizers	6880B	III-8
EASYWAVE	9400/SW	II-16		TR8818A	III-12, 13, 16
Effective Bits	Theory	IV-8, 59-63		TR8828D	III-12, 13, 16
Extrema	Oscilloscopes	I-17, 28, 50		6810/6310	III-24, 26
Fan Out	6128	III-46		8212A/8800A	III-30
FASTBUS		III-78	Memories, Segmented	9400 Series	I-48
FFT, Fourier Transforms	Theory	IV 44-47		TR8818A	III-13, 14
	9420/24/50	I 19-21, 50		TR8828D	III-13, 14
	9400A	I 30-33		6389/6309	III-19
	7200 Series	I 41, 44, 47		7900	III-20, 22
				6810	III-27, 29
Fiberoptics			Memory Configurations	TR8818A	III-16
Receiver, Analog	5613	III-39		TR8828D	III-16
Transmitter, Analog	5612	III-39		7900	III-21
Frequency Domain	Theory	IV 44-47		6810	III-29
Function Generators			Model Index	Appendix J	V-20
200 MP/s, 8-bit, 2 ch	9100	II-4	Modularity	7200 Series	III-42
200 MP/s, 8-bit, 1 ch	9101	II-8	Modular Digitizers	Theory	III 2-5
200 MP/s, 2 ch, dig.o/p	9109	II-10	Accessories	Accessories	III-35
50 MP/s, 2 ch, 12-bit	9112	II-12	Architectures	Theory	IV-10
Gate Generator	2323A	III-42	Fundamentals of	Theory	III 2-5; IV-1
	4222	III-42	How to Configure	Theory	III-5
Generating Arbitrary Waveforms	Theory	IV-50	Selection Guide	Theory	III-4
Glossary of Technical Terms	Appendix A	V 1-7	1.3 GS/s, 8 bits	6880B	III-6
GPIB to CAMAC Interface	8901A	III-54	100 MS/s, 8 bits	TR8818A	III-12
Hand Held Control Panel	9100/CP	II-5, 7, 14	200 MS/s, 8 bits	TR8828D	III-12
Hard Disk	7200 Series	I-41, 47	5 MS/s, 12 bits	6810	III-24
High Energy Physics	Intro	v	100 KS/s, 12 bits	8212A	III-30
High Resolution	Theory	IV-19	80 MS/s, 10 bits, Quad	2262	III-32
High Voltage Systems	Intro, III	v, III-78	Monolithics, Custom	III-79	
Housings			Nuclear Products	Intro	v
650 W, 25 slots	1434A	III-71	Ordering Information	Appendix E	V-13
400 W, 13 slots	8013A	III-71	Organization, LeCroy Corp.	Cover 3	
1000 W, 25 slots	8025	III-74	Parameters, Time Domain	9450	I-7, 48
Plug-in Digital Oscilloscope	7200	I-40		9420	I-11
Hybrids, Custom		III-78		9424	I-15
IEEE-583, CAMAC, Introduction	Theory	III-80		7200	I-47
Glitch Characterization	9400 Series	I-49	Plug-ins		
GSA Contract, Products on	Appendix F	V-14	Digital Scopes	7200 Series	I-41, 47
Inputs, Differential	6810	III-25	CAMAC modules	Selections	III-1, 4
Installation	W&S	xvii	Power Supplies		
Instapulser	Accessories	I-52	CAMAC, 650 W	1434A	III-71
Interfaces			CAMAC, 400 W	8013A	III-71
Modular	8901A	III-54	CAMAC, 1000W	8025	III-74
With internal controller	6010	III-48	President's "E" Award	Intro	viii
Wavecorder, Listing of	7900	III-35	Processing, Waveform		
LeCroy Corporation			ASYSY	6920-488	III-63, 67
Tradition	Intro	v	Averaging, Math, Fns	9420/24/50	I 16-18
Organization	General	Intro		General Theory	IV-6, 43
Level Adapter	6128	III-46		9400A	I 27-29
Licensing, Software	W&S	xv		7200 Series	I 41, 44, 47
Mainframe, CAMAC			Catalyst	6900	III-56
650 W, 25 slots	1434A	III-71	Signal Processing	Theory	IV-40
400 W, 13 slots	8013A	III-71			
1000 W, 25 slots	8025	III-74			



Description	Model/Subject	Page	Description	Model/Subject	Page
(Processing, Waveform cont.) Spectrum Analysis	9420/24/50 9400A 7200 Series	I 19-22 I 30-33 41,45,47	Smoothing	Theory 9400A	IV-6,42 I-28
Publications, Applications Pulse Parameters	Appendix B 9450 9420 9424 7200 Series	V-9 I-4 I-8 I-12 I-40	Software Development Package Software, PC	6910-DEV	III-59
Pulser	IP-2	I-52	ASYST	6920-488	III-63
Purchase Justification Form	Appendix H	V 17-19	CALSOFT	9400CS01	I-37
Receiver, Fiberoptic	5613	III-39	Digitizer Drivers	6920-DL	III-68
Resistor Codes	Appendix D	V-12	Mass Storage (MASP)	9400AMS01	I-34
Resolution, Enhanced	6880B 9450/20/24 7200 Series	III-10 I-17,18 I-42	Waveform Catalyst	6900	III-56
Resolution, High	Theory 6810 8212A	IV-19 III 24,26 III-30,31	Spectrum Analysis	9420/24/50 9400A 7200 Series	I 19-22 I 30-33 41,44,47
Sales & Service Offices	Theory Appendix G	IV-19 V-15,16	Technical Terms, Glossary	Appendix A	V 1-8
Sampling, Single Shot			Time Base, Dual	6810	III-25,26,28
Digital Scopes	9450 9420 9424 9400A 7200 Series	I-4 I-8 I-12 I-23 I-40	Training	W&S	xvii
Modular Digitizers	6880B TR8818A TR8828D 6810 8212A 2262 General Intro	III-6 III-12 III-12 III-24 III-30 III-32 III 1-5 vii	Transient Recording		
SBA Award			Digital Oscilloscopes	9450 9420 9424 9400A 7200 Series	I-4 I-8 I-12 I-23 I-40
Service			Modular Digitizers	6880B TR8818A TR8828D 6810 8212A 2262	III-6 III-12 III-12 III-24 III-30 III-32
Blue Ribbon	W&S	xvi	Transmitter, Fiberoptic	5612	III-39
Calibration	W&S	xvi	Trigger Generator	6103	III-36
Expedited Repairs	W&S	xvii	Triggering		
Installation	W&S	xvii	Digital Scopes	Theory	IV-9,24-31
Locations	Appendix G	V-15,16	Arbitrary Fn. Generators	Theory	IV-51
On-call Repairs	W&S	xvii	Triggers, SMART		
Procedure	W&S	xv	Digital Scopes	Theory 9450 9420 9424 7200	IV 24-31 I-5,6,7,50 I 8-10,49 I-13,15,16 I-43,46
Returns	W&S	xv	Digitizers	6810	III 27-29
Supplemental Support	W&S	xvi	Warranty	W&S	xv
Training	W&S	xvii	Warranty, Extended	W&S	xvi
Warranty	W&S	xv	Waveform Catalyst	6900	III-56
Warranty, Extended	W&S	xvi	Waveform Creation	9100/SW	II-3,16,20
Signal Averaging	Theory 9420/24/50 9400A 7200 Series 6010 6880B 6810 6900	IV-6,43 I 16-18,50 I 27-29,50 I 41,44,47 III 50,52,53 III-8,10 III-29 III-57	Waveform Digitizers		
Signal Conditioning, Modular			Low Cost	2262	III-32
Amplifier	6103	III-36	See "Transient Recording"		
Attenuator	8102	III-36	Waveform Editing	9100/SW	II-5,18,20
			Waveform Generation	Theory	IV-50
			200 MP/s,8-bit,2 ch	9100	II-4
			200 MP/s,8-bit,1 ch	9101	II-8
			200 MP/s,2 ch, dig.o/p	9109	II-10
			50 MP/s,2 ch,12-bit	9112	II-12
			Wavecorder	7900-9109LM	III-23
			Window Functions	Theory	IV-46,47
				9420/24/50	I 19-22
				9400A	I 30-32
				7200 Series	I 47



# LeCroy Information Request Card

- I can't wait.
- Call me at ( \_\_\_\_\_ ) \_\_\_\_\_
- Please send me...**
- Commercial Price List
- GSA Price List
- Blue Ribbon Service,  Extended Warranties
- Application Notes (#): \_\_\_\_\_

- Instrumentation Seminar Schedule For My Area (15)
- 1990 Research Instrumentation Catalog (109)

- Add/Correct my name to/on your mail list
- Remove my name from your mail list
- Name \_\_\_\_\_ Title \_\_\_\_\_
- Company \_\_\_\_\_ Mail Stop \_\_\_\_\_
- Address \_\_\_\_\_
- City \_\_\_\_\_
- State/Province \_\_\_\_\_ Zip/Postal Code \_\_\_\_\_
- Please send a catalog to a colleague
- Name \_\_\_\_\_ Title \_\_\_\_\_
- Company \_\_\_\_\_ Mail Stop \_\_\_\_\_
- Address \_\_\_\_\_
- City \_\_\_\_\_
- State/Province \_\_\_\_\_ Zip/Postal Code \_\_\_\_\_

# LeCroy Information Request Card

- I can't wait.
- Call me at ( \_\_\_\_\_ ) \_\_\_\_\_
- Please send me...**
- Commercial Price List
- GSA Price List
- Blue Ribbon Service,  Extended Warranties
- Application Notes (#): \_\_\_\_\_

- Instrumentation Seminar Schedule For My Area (15)
- 1990 Research Instrumentation Catalog (109)

- Add/Correct my name to/on your mail list
- Remove my name from your mail list
- Name \_\_\_\_\_ Title \_\_\_\_\_
- Company \_\_\_\_\_ Mail Stop \_\_\_\_\_
- Address \_\_\_\_\_
- City \_\_\_\_\_
- State/Province \_\_\_\_\_ Zip/Postal Code \_\_\_\_\_
- Please send a catalog to a colleague
- Name \_\_\_\_\_ Title \_\_\_\_\_
- Company \_\_\_\_\_ Mail Stop \_\_\_\_\_
- Address \_\_\_\_\_
- City \_\_\_\_\_
- State/Province \_\_\_\_\_ Zip/Postal Code \_\_\_\_\_

# LeCroy Information Request Card

- I can't wait.
- Call me at ( \_\_\_\_\_ ) \_\_\_\_\_
- Please send me...**
- Commercial Price List
- GSA Price List
- Blue Ribbon Service,  Extended Warranties
- Application Notes (#): \_\_\_\_\_

- Instrumentation Seminar Schedule For My Area (15)
- 1990 Research Instrumentation Catalog (109)

- Add/Correct my name to/on your mail list
- Remove my name from your mail list
- Name \_\_\_\_\_ Title \_\_\_\_\_
- Company \_\_\_\_\_ Mail Stop \_\_\_\_\_
- Address \_\_\_\_\_
- City \_\_\_\_\_
- State/Province \_\_\_\_\_ Zip/Postal Code \_\_\_\_\_
- Please send a catalog to a colleague
- Name \_\_\_\_\_ Title \_\_\_\_\_
- Company \_\_\_\_\_ Mail Stop \_\_\_\_\_
- Address \_\_\_\_\_
- City \_\_\_\_\_
- State/Province \_\_\_\_\_ Zip/Postal Code \_\_\_\_\_





NO POSTAGE  
NECESSARY  
IF MAILED  
IN THE  
UNITED STATES

**BUSINESS REPLY MAIL**  
First Class Mail    Permit No. 164    Spring Valley, NY

POSTAGE WILL BE PAID BY ADDRESSEE

**LeCroy Corporation**  
700 Chestnut Ridge Road - Dept C  
Chestnut Ridge, NY 10977-9981

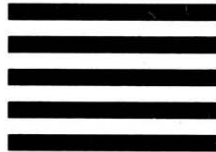

NO POSTAGE  
NECESSARY  
IF MAILED  
IN THE  
UNITED STATES

**BUSINESS REPLY MAIL**  
First Class Mail    Permit No. 164    Spring Valley, NY

POSTAGE WILL BE PAID BY ADDRESSEE

**LeCroy Corporation**  
700 Chestnut Ridge Road - Dept C  
Chestnut Ridge, NY 10977-9981

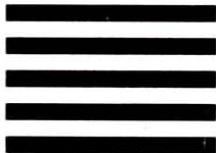

NO POSTAGE  
NECESSARY  
IF MAILED  
IN THE  
UNITED STATES

**BUSINESS REPLY MAIL**  
First Class Mail    Permit No. 164    Spring Valley, NY

POSTAGE WILL BE PAID BY ADDRESSEE

**LeCroy Corporation**  
700 Chestnut Ridge Road - Dept C  
Chestnut Ridge, NY 10977-9981

